



Healthcare Furniture

Beds, Trolleys, Tables, Lockers
and SS/MS Accessories

Index

Bed

Motorized Range

Page 8 — 23

Chrysalis Nova Activ Bed	10
Chrysalis Nova Plus Bed	12
Chrysalis Nova Bed	14
Chrysalis TWCL Bed	16
Chrysalis SWDL Bed	18
Acura Prime Plus E.P 5F Bed	20
with PP Sideboards	
Acura Prime XP 5F Bed	22
with PP Sideboards	
Acura Prime XP 5F Bed	24
with Aluminum Sideboards	
Acura Vital 2F Bed	26
with PP Sideboards	
Grace 2F Homecare Bed	28

Semi-Motorized Range

Page 30 — 33

Acura Standard 3F Bed	30
with Sideboards	
Acura Lite 3F Bed	32
with MS Side rail	

Manual ICU Range

Page 34 — 37

Acura Standard 5F Bed	34
with Sideboards	
Acura Neo 5F Bed	36
with Sideboards	
Acura Lite 5F Bed	38
with MS Side rails	

Manual Range

Page 40 — 50

Acura Vital 2F Bed	40
with PP Sideboards	
Ayush Plus Lite Fowler Bed	42
PP	
Ayush Plus Lite Fowler Bed	43
SSPLT	
Ayush Lite Fowler Bed	44
MS	
Ayush Plus Lite Semi Fowler Bed	45
PP	
Ayush Plus Lite Semi Fowler Bed	46
SSPLT	
Ayush Lite Semi Fowler	47
MS	
Ayush Plus Lite Sheet	48
SSPLT	
Ayush Lite Sheet	49
MS	
Ayush Lite Attendant bed	50
MS	

Couch

Motorized Range

Page 51 — 54

Repos Procedure Couch	52
Repos Gynaec Couch	53
Repos Physical Examination Table ..	54

Manual Range

Page 55 — 56

Revive Full Storage Couch	55
Examination Table on RTC	56
Examination Table on RTC – Gync ...	56

Infant Crib & Trolley

Page 57 – 59

Pediatric Bed	58
Crib on Trolley	59
Crib on Bed	59

Birthing Bed

Page 60 – 63

Solace LDRP Bed	60
Solace Lite LDRP Bed.....	62

Locker

Page 65 — 68

Aptis Locker	66
2 drawer 1 cabinet	
Aptis Locker	67
1 drawer 1 cabinet	
Aptis Locker	67
1 cabinet	
Delux Locker	68
Simple Locker	68

Over Bed Table

Page 69 – 71

Adeo OBT on Gas Lift Split Type	69
Aptis OBT on Gas Lift	70
Aptis OBT on Crank	70
Ayush Fixed HT OBT	71

Patient Mobility

Page 72 — 74

Stretcher on Trolley	72
Rapid NEO ERT	73
Wheelchair Cushion	74

Agilo Medical Trolley

Page 75 — 77

Agilo Medicine Cart	75
Agilo Emergency Crash Cart	76
SS Crash Cart	77

SS Trolleys & Carts

Page 78 — 81

Instrument Trolley BB	79
Instrument Trolley	79
Medicine Trolley	80
Mayo Trolley	80
Instrument Cabinet	81
Oxygen Cylinder Trolley	81

SS & MS Accessories

Page 82 — 88

Kick Bucket	82
Basin Stand	82
Single Step stool	83
Double Step stool	83
Square Stool	84
Round Stool	84
3 fold screen	85
Soil linen trolley	85
Lite IV pole	86
Infusion Pole	86
3 bar MS Saline stand	86
3 bar SS Saline stand	86
SS and MS Side rails	87
Traction Pulley	88
Patient Lifting Pole.....	88

Mattress

Page 89 — 92

Chrysalis Mattress	90
Acura Mattress	91
4 Section Mattress	92
2 Section Mattress	92
Single Section Mattress	93
Attendant bed Mattress	93
Crib Mattress	94
Pediatric bed mattress	94
Examination Table Mattress	95
Rapid ERT Mattress	95
Solace Mattress	96

Recommended Products

Page 97 — 106

Medical Heads /	
Senior Doctor's Room	98
– Impress	
– Maestro	
– Astro & Marvel	
Training Room	99
– Enlighten	
– Unlearn	
– Flip NXT	
– Scintilla with Desklet	
Lab	100
– Fusion	
– Nucleus	
– Aeolus	
Record Room	101
– Optimizer Plus	
– Personal Locker Unit	
– Gain	
Library	102
– Book Rack	
– Glass Door Storwel	
– Storwel Plain	
Meeting Room	102
– Conclave	
Admin and Nursing Station	103
– Wish	
– VSDU	
– LFC	
– Mobile Caddy	
– VFC	
Cafeteria	104
– Cantina	
– Flip NXT	
– Time Out	
– Unwind	
OPDS	105
– Enterprise	
– Work	
– Motion	
Waiting Area	106
– Matrix	
– Unwind on Beam	
– Greet	

Better Healthcare For Everyone



Godrej Interio Healthcare creates environments that support the healing process. By aligning efficiency with empathy, our healing environments maximise the wellbeing of all stakeholders involved: Patients, Caregivers, and Doctors.

We believe that a good healing environment focuses on the patients and their relatives, while simultaneously helping caregivers become more efficient and doctors more comfortable. Our design philosophy adopts a human-centric approach to increase the harmony between spaces and products, resulting in an improved patient-doctor interaction.

Additionally, we bring our expertise in OCE space design to create people-centric spaces such as canteens, lounges, waiting areas, meeting and video conferencing rooms, and storage solutions. We can design and deliver a complete healthcare space as per your budget, and furnish the same. Our Healthcare furniture products are ISO 13485 certified, USFDA registered, and rated for CE certification from the European notifying body.

Space is our playground. And it's our endeavour to make life the winner.

Studies that Inform our Designs

Space design is the study of the workflow between various stakeholders.



Our recent study revealed that Caregivers, the vital stakeholders in the healing process, walk 8-10 kms in an 8-hour shift due to incorrectly designed spaces.

Here are some of the other insights from our research:

- More than 90% of the nursing staff complained of some form of MSD (musculoskeletal disorder)
- The most prevalent pain areas were the legs (56%), followed by the knees (51%)
- 51% complained of upper and lower back issues
- 61% also experienced neck pain sometimes
- 41% of the nursing staff took 1-3 days leave, whereas 7% of them had taken a leave for 4-6 days within a span of two months to manage their pain. This indicates a clear productivity loss to the organisation.



Challenges that Motivate our Goals

Everyday, Caregivers strive hard to provide superior healthcare services to their people. It's their zeal that motivates us to create better and safer healing environments for everyone. We learn from their challenges and design products and develop spaces to create an intuitive, dynamic, and ergonomic healing environment.

Thus, our goal is to become the ultimate facilitators for care, and the support system that patients, family members, caregivers, and doctors can rely upon.

Designed For All Medical Needs. General, Multiple, or Specialised.

Our design team doesn't limit itself to improving established solutions. Our products cater to key customer needs across a variety of healthcare environments, while also being equipped to simultaneously serve multiple other use-cases as well.



Here are the parameters that govern Godrej Interio Healthcare products:

■ Global Safety Standards

All our products adhere to the most stringent global standards and quality certifications. We make sure that every product created has:

- No Sharp Edges
- No Electrostatic Charge
- No Cold Shock
- All Entrapment Zones Taken Care Of
- Fall Protection

■ Uncompromised Comfort

We believe that a safe healing environment is one that's not only comfortable to the patients, but also to their caregivers. That's why our products come with:

- Easy-To-Use Controls/Crank Handles
- Ergonomic Design
- Easy Manoeuvrability
- Compatibility With Associated Products and Surroundings

■ Assured Hygiene & Easy Maintenance

Godrej Interio Healthcare products are coated with bacteriostatic powder to ensure infection control and better pre-treatment procedures. Their simple construction provides easy access for cleaning and fumigation.

About Us

Godrej Interio (GI) is India's premium furniture brand in both home and institutional segments with a strong commitment to sustainability and centers of excellence in design, manufacturing and retail.

Led by the largest in-house design team in the country in the furniture category and awarded with 34 India Design Mark Awards till date, GI aims to transform spaces with its thoughtfully designed furniture to create brighter homes and offices with products that have the highest design quotient in aesthetics, functionality and technology. With consistent pursuit of excellence and a special focus on health and ergonomics, GI's product portfolio comprises a massive range.

Today, we design and manufacture furniture for office spaces, homes, educational institutes, healthcare facilities, laboratories and more. Along with furniture we offer Audio Visual and 360 Degree Turnkey solutions. Each of our product range revolves around comfort and aesthetics while delivering well-designed, fun and functional furniture solutions. Briefly, Godrej Interio transforms dream spaces to life!

Godrej Interio has 8 manufacturing facilities situated at Mumbai, Haridwar, Shirwal, Khalapur and Bhagwanpur. GI's Shirwal Plant is GreenCo Platinum Certified and Mumbai Plants are GreenCo Gold Certified. GI is widely known for its comprehensive sustainability certifications for its products in furniture category.

GI's commitment to the environment has resulted in manufacturing products with lesser environment burdening products, usage of eco-friendly materials and setting up less polluting and consuming processes, ensuring eco-friendly packaging, and transportation and finally the extended responsibility of recycling/reuse of used furniture and scrap, thus ensuring a lifecycle approach to green. GI has the widest range of green choices for our customers, which not only includes products but also services such as green interiors and recycling.

Currently present in over 650 cities with 300+ exclusive showrooms and 1200 dealers, GI is one of the largest divisions of Godrej and Boyce Mfg. Co. Ltd., part of the Godrej Group, one of India's largest engineering and customer product groups.



Chrysalis Nova Plus Bed

→ Pg12



Bed



Page
10 — 30 **Motorized
Range**



Page
30 — 33 **Semi
Motorized
Range**

Page
34 — 39 **Manual
ICU Range**

Page
40 — 50 **Manual
Range**

Chrysalis Nova Activ Bed



DESIGN REGISTERED

Colour



Grey



Blue

Features

Head/Foot board	Easy removable board made of polypropylene (PP).
Lying Surface	Removable cover made of Acrylonitrile Butadiene Styrene (ABS), easy to clean and maintain.
Safety Sideboards	PP Sideboards have a dropdown mechanism with a control panel.
Control Panel	<ol style="list-style-type: none"> 1. Embedded Control Panel – Backrest, Knee Rest, Hi-Low, Trendelenburg, Reverse Trendelenburg, Cardiac Chair Position, Emergency CPR, Lock Button. 2. Digital Control Panel – Backrest, Knee Rest, Hi-Low, Trendelenburg, Reverse Trendelenburg, Lateral Tilt Cardiac Chair Position, Emergency CPR, Lock Button, Weight Measurement Scale, Bed Exit Alarm.
Castors	12.5cm, Twin wheel central locking.
Safe working load	250kg

Specification
All sizes in cm

	Length	Depth	Height
Overall dimension	220.6	101.0	50.0 to 86.0
Platform dimension	190.0	84.0	-

Chrysalis Nova Activ Bed

Positions

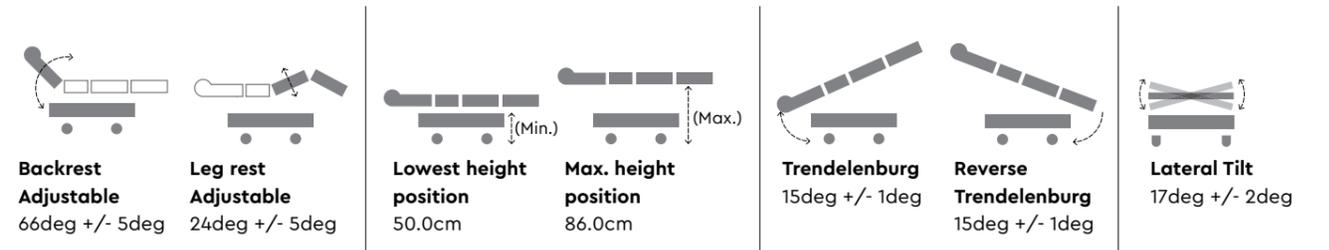

Accessories that comes along with the bed

Bed Extender for Taller Patient	Linen Holder	Patient Restrainer Belt Holder	Accessories Rail on both sides
Dual side CPR Lever	Bumpers on all corners	ACT for Weight Management	Ratchet for Achieving DVT
6 embedded Control Panel	Under Bed Light	Bed Exit Alarm + Digital Angle & Height Indicator	Heavy Duty SS 304 Infusion Pole

Optional Accessories

Mattress 10cm →Pg 91	Bed Extender Mattress	Oxygen Cylinder Trolley →Pg 81	Battery Backup
Chart Holder	Lite IV Pole →Pg 86	X-Ray Permeable Backrest	

Chrysalis Nova Plus Bed



DESIGN REGISTERED

Colour



Grey



Blue

Features

Head/Foot board	Easy removable board made of polypropylene (PP).
Lying Surface	Removable cover made of Acrylonitrile Butadiene Styrene (ABS), easy to clean and maintain.
Safety Sideboards	PP Sideboards have a dropdown mechanism with a control panel.
Control Panel	1. Embedded Control panel: Backrest, Knee rest, Hi-Low, Trendelenburg, Reverse Trendelenburg, Cardiac Chair Position, Emergency CPR, Lock Button, Bed Exit Alarm. 2. Weight Assist Panel for weight management.
Castors	12.5cm, imported castors model, Twin wheel central locking.
Safe working load	250kg

Specification
All sizes in cm

	Length	Depth	Height
Overall dimension	220.6	101.0	42.5 to 77.5
Platform dimension	205.0	85.6	-

Chrysalis Nova Plus Bed

Positions

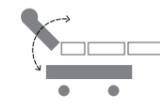

Backrest Adjustable
66deg +/- 5deg

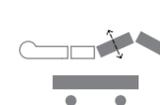

Leg rest Adjustable
24deg +/- 5deg



Lowest height position
42.5cm

Max. height position
77.5cm



Trendelenburg
15deg +/- 1deg

Reverse Trendelenburg
15deg +/- 1deg

Accessories that comes along with the bed



Heavy Duty SS 304 Infusion Pole

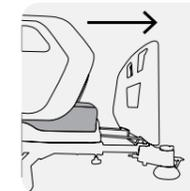

Bed Extender for Taller Patient



Linen Holder

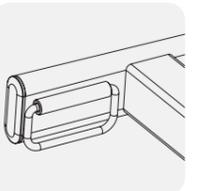

Patient Restrainer Belt Holder

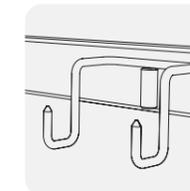

Accessories Rail on both sides

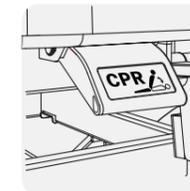

Dual Side CPR Lever

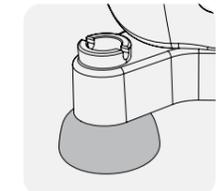

Bumpers on all corners

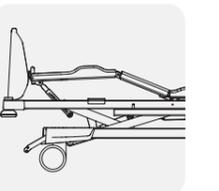

Ratchet for Achieving DVT

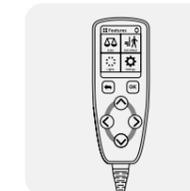

Weight Assist Panel for Weight Management



Patient Control Handset



4 embedded Control Panel

Optional Accessories



Mattress 10cm → Pg 91

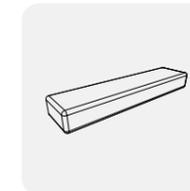

Bed Extender Mattress

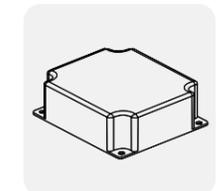

Battery Backup

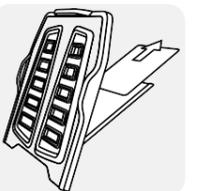

X-Ray Permeable Backrest

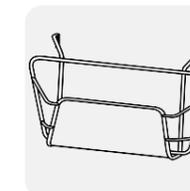
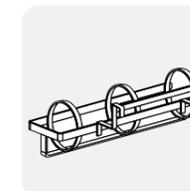
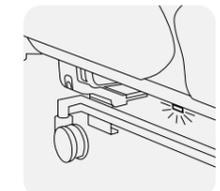

Chart Holder



Oxygen Cylinder Cage



Under Bed Light

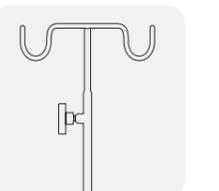

Lite IV Pole → Pg 86

Chrysalis Nova Bed



Colour



Grey



Blue

Features

Head/Foot board	Easy removable board made of polypropylene (PP).
Lying Surface	Removable cover made of Acrylonitrile Butadiene Styrene (ABS), easy to clean and maintain.
Safety Sideboards	PP Sideboards have a dropdown mechanism with a control panel.
Control Panel	Embedded Control Panel – Backrest, Knee Rest, Hi-Low, Trendelenburg, Reverse Trendelenburg, Cardiac Chair Position, Emergency CPR, Lock Button.
Castors	12.5 cm, imported castors model, Twin wheel central locking.
Safe working load	250kg

Specification
All sizes in cm

	Length	Depth	Height
Overall dimension	220.6	101.0	42.5 to 77.5
Platform dimension	205.0	85.6	-

Chrysalis Nova Bed

Positions

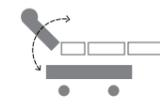

Backrest Adjustable
66deg +/- 5deg

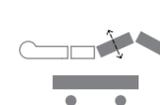

Leg rest Adjustable
24deg +/- 5deg

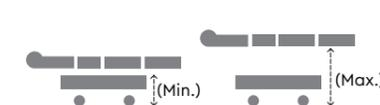

Lowest height position
42.5cm

Max. height position
77.5cm



Trendelenburg
15deg +/- 1deg

Reverse Trendelenburg
15deg +/- 1deg

Accessories that comes along with the bed

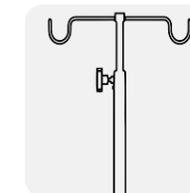

Heavy Duty SS 304 Infusion Pole

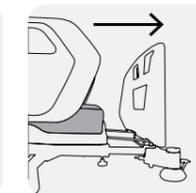

Bed Extender for Taller Patient



Linen Holder

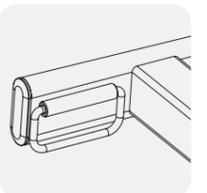

Patient Restrainer Belt Holder

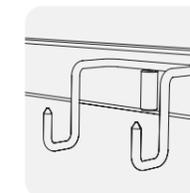

Accessories Rail on both sides

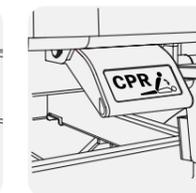

Dual Side CPR Lever

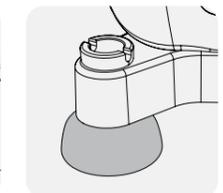

Bumpers on all corners



4 embedded Control Panel

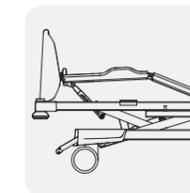

Ratchet for Achieving DVT

Optional Accessories



Patient Control Handset

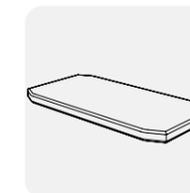

Mattress 10cm → Pg 91

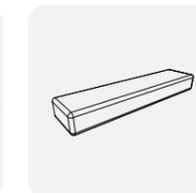

Bed Extender Mattress

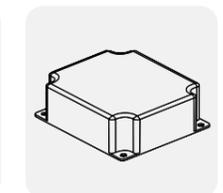

Battery Backup



X-Ray Permeable Backrest

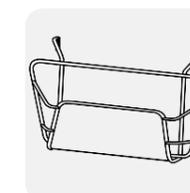
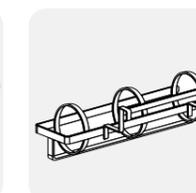
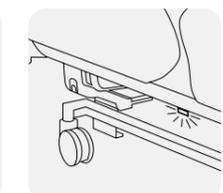

Chart Holder



Oxygen Cylinder Cage



Under Bed Light

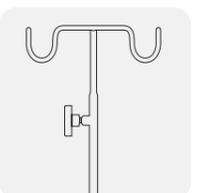

Lite IV Pole → Pg 86

Chrysalis TWCL Bed



DESIGN REGISTERED

Colour



Features

Head/Foot board	Easily removable board made of Polypropylene (PP).
Lying Surface	Removable cover made of Acrylonitrile Butadiene Styrene (ABS), easy to clean and maintain.
Safety sideboards	PP Sideboards with dropdown mechanism covering complete bed length.
Control Panel	Attendant control panel: Backrest, Knee Rest, Hi-low, Trendelenburg, Reverse Trendelenburg, Auto Contour, Cardiac Chair, Emergency CPR, Lock Button.
Castors	12.5cm, imported castors model, Twin Wheel Central Locking.
Safe working load	250kg

Specification
All sizes in cm

	Length	Depth	Height
Overall dimension	220.6	101.0	42.5 to 77.5
Platform dimension	205.0	85.6	-

Chrysalis TWCL Bed

Positions

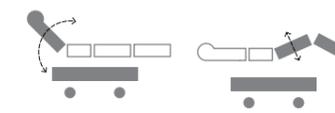

Backrest Adjustable
66deg +/- 5deg

Leg rest Adjustable
24deg +/- 5deg



Lowest height position
42.5cm

Max. height position
77.5cm



Trendelenburg
15deg +/- 1deg

Reverse Trendelenburg
15deg +/- 1deg

Accessories that comes along with the bed

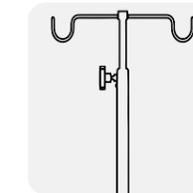

Heavy Duty SS 304 Infusion Pole

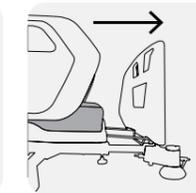

Bed Extender for Taller Patient



Linen Holder

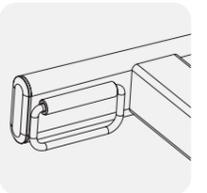

Patient Restrainer Belt Holder

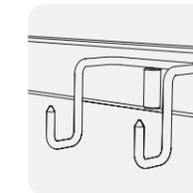

Accessories Rail on both sides

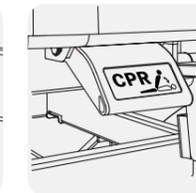

Dual Side CPR Lever

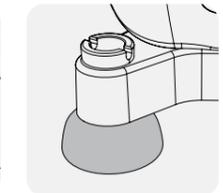

Bumpers on all corners

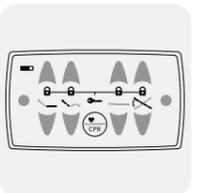

Attendant Control Panel

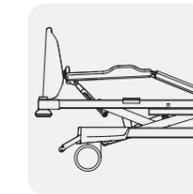

Ratchet for Achieving DVT

Optional Accessories



Patient Control Handset



Mattress 10cm → Pg 91

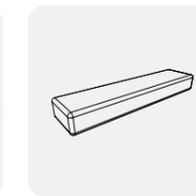

Bed Extender Mattress

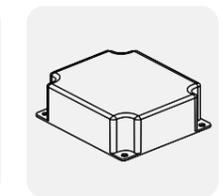

Battery Backup

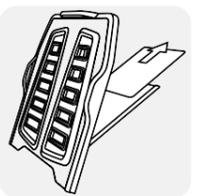

X-Ray Permeable Backrest

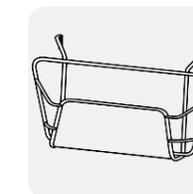
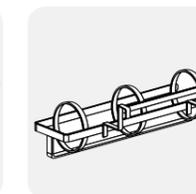
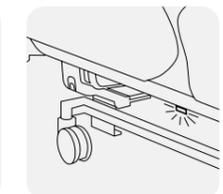

Chart Holder



Oxygen Cylinder Cage



Under Bed Light

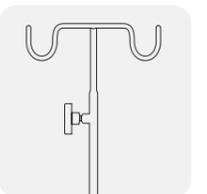

Lite IV Pole → Pg 86

Chrysalis SWDL Bed



DESIGN REGISTERED

Colour



Features

Head/Foot board	Easily removable board made of Polypropylene (PP).
Lying Surface	Removable cover made of Acrylonitrile Butadiene Styrene (ABS), easy to clean and maintain.
Safety sideboards	PP Sideboards with dropdown mechanism covering complete bed length.
Control Panel	Attendant control panel: Backrest, Knee Rest, Hi-low, Trendelenburg, Reverse Trendelenburg, Auto Contour, Cardiac Chair, Emergency CPR, Lock Button.
Castors	12.5cm, imported castors model, Single Wheel Diagonal Locking.
Safe working load	250kg

Specification
All sizes in cm

	Length	Depth	Height
Overall dimension	220.6	101.0	45.5 to 81.0
Platform dimension	205	85.6	-

Chrysalis SWDL Bed

Positions



Backrest Adjustable
66deg +/- 5deg

Leg rest Adjustable
24deg +/- 5deg



Lowest height position
45.5cm

Max. height position
81cm



Trendelenburg
15deg +/- 1deg

Reverse Trendelenburg
15deg +/- 1deg

Accessories that comes along with the bed

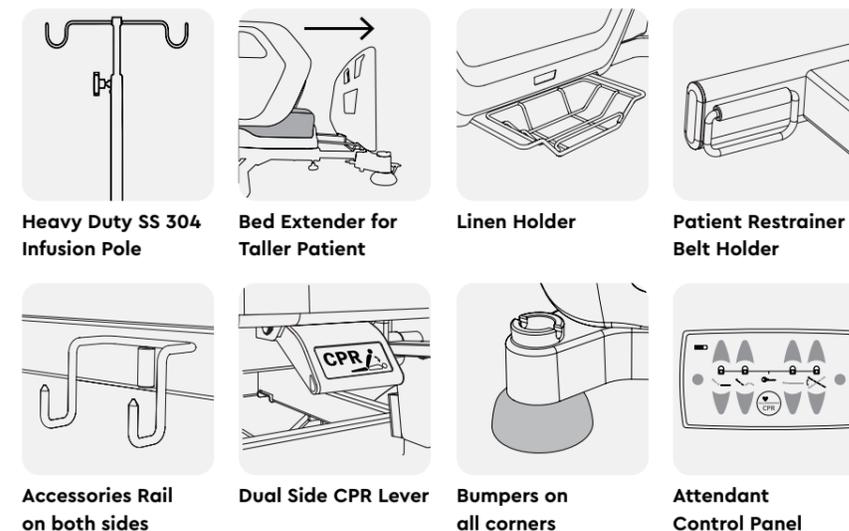

Optional Accessories

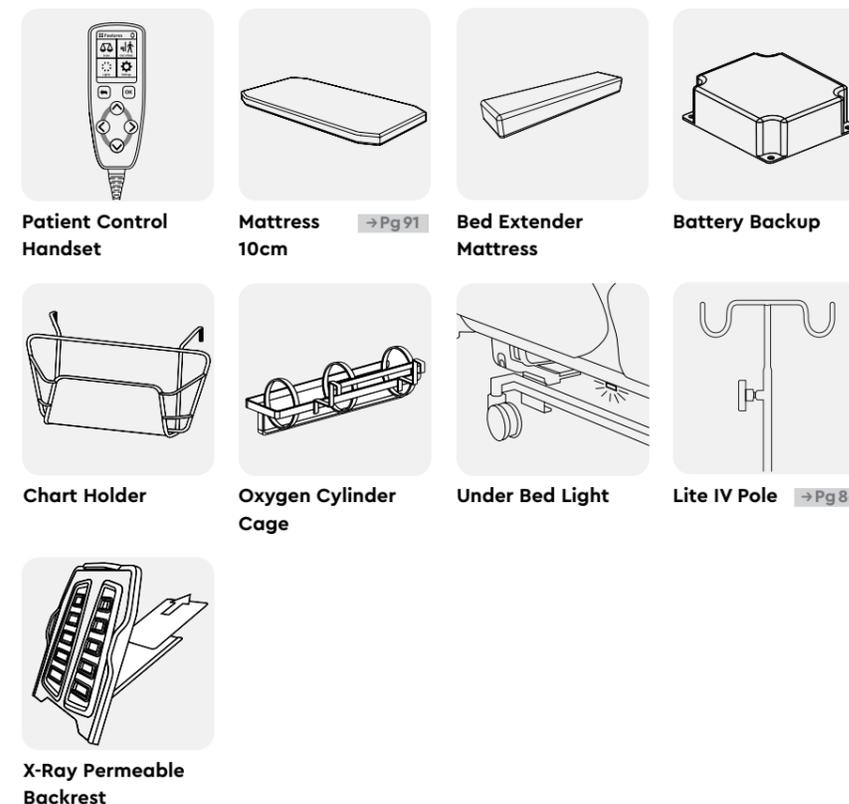

Acura Prime Plus Embedded Panels 5F Motorized Bed

With PP Sideboards



Features

Head/Foot board	Easily removable head/foot board made of Polypropylene (PP).
Lying Surface	PP injection-moulded removable cover which is easy to clean.
Safety sideboards	PP Sideboards with dropdown mechanism.
Control Panel	2 Patient Panels – Height, Backrest, Leg Rest, Auto Contour, Cardiac Chair And UBL. 2 Attendant Control Panel – Height, Backrest, Leg Rest, TR/ATR, Auto Contour, UBL, CPR, Lock Function, Power And Battery Indicator, Cardiac Chair And Emergency Head Low Position.
Castors	12.5cm, imported castors model, Twin Wheel Diagonal Locking / Twin Wheel Central Locking.
Safe working load	200kg

Specification
All sizes in cm

	Length	Depth	Height
Overall dimension	224.1	105.0	44.0 to 77.0
Platform dimension	195.0	88.0	-

Acura Prime Plus Embedded Panels 5F Motorized Bed

With PP Sideboards

Positions

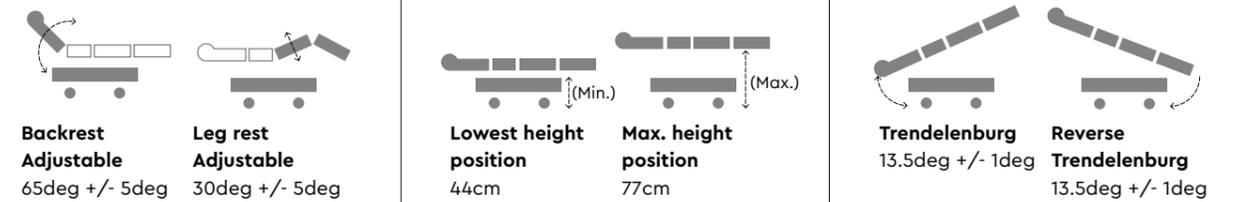

Accessories that comes along with the bed

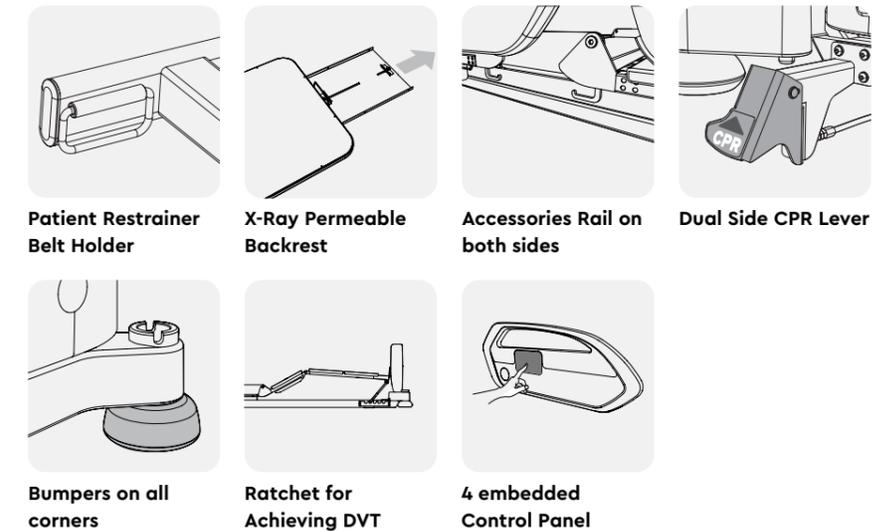

Optional Accessories

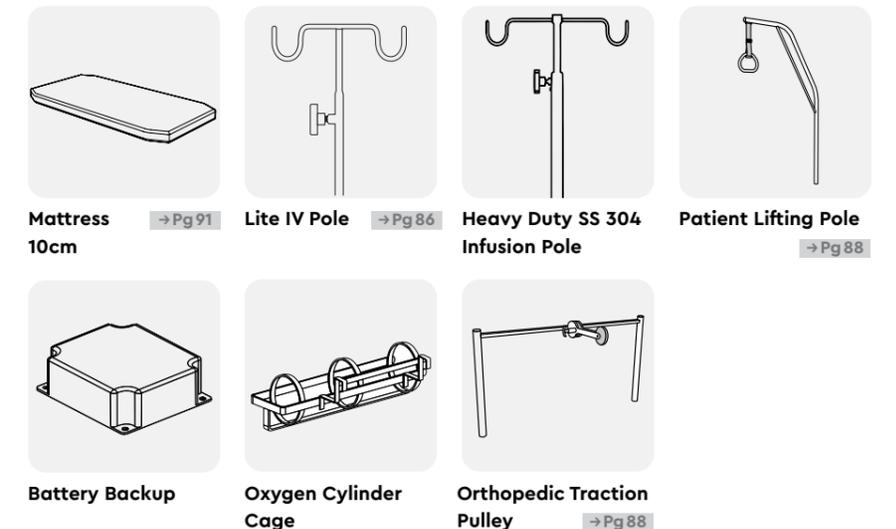

Acura Prime XP 5F Motorized Bed

With PP Sideboards



Features

Head/Foot board	Easily removable head/foot board made of Polypropylene (PP).
Lying Surface	PP injection-moulded removable cover which is easy to clean.
Safety sideboards	PP Sideboards with dropdown mechanism.
Control Panel	Attendant control panel: Backrest, Knee Rest, Hi-low, Trendelenburg, Reverse Trendelenburg, Auto Contour, Emergency CPR, Lock Button.
Castors	12.5cm, imported castors model, Twin Wheel Diagonal Locking.
Safe working load	200kg

Specification
All sizes in cm

	Length	Depth	Height
Overall dimension	224.1	105.0	44.0 to 77.0
Platform dimension	195.0	88.0	-

Acura Prime XP 5F Motorized Bed

With PP Sideboards

Positions

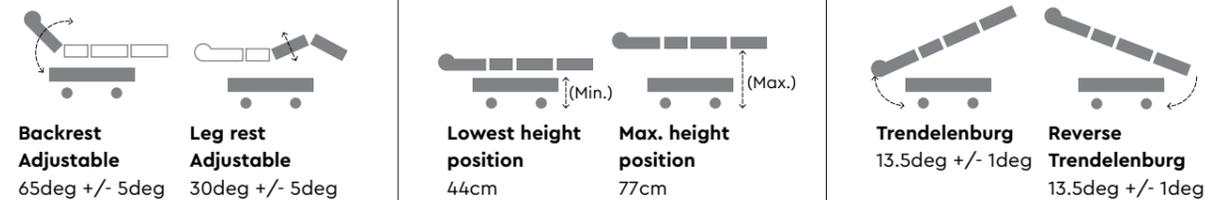

Accessories that comes along with the bed

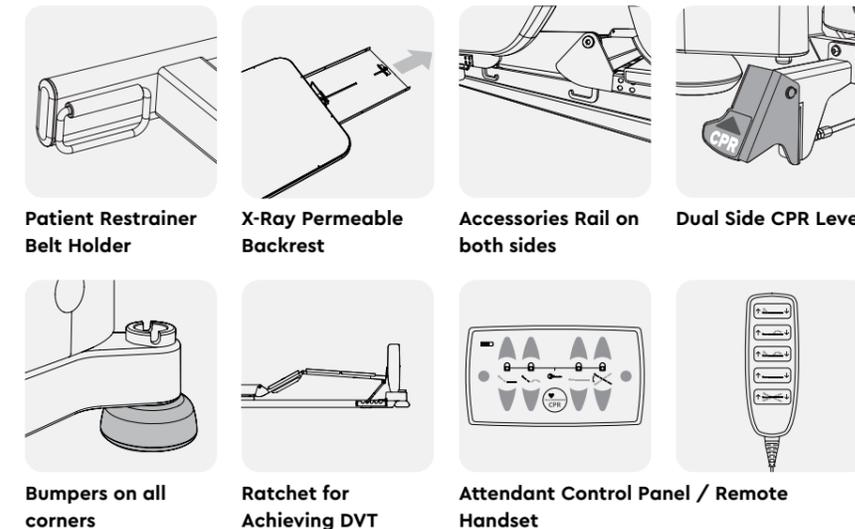

Optional Accessories

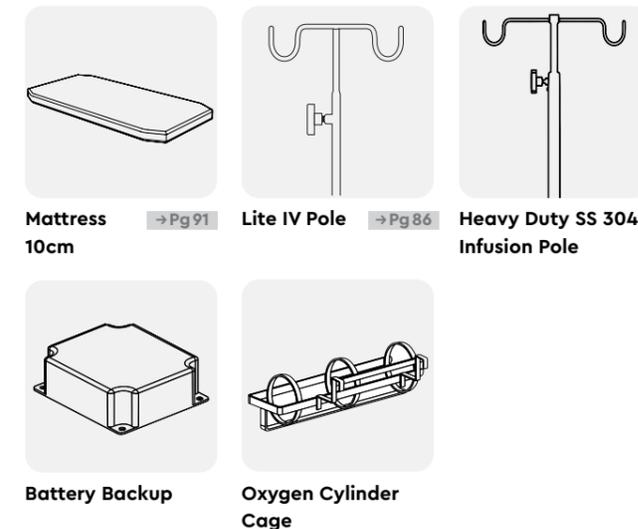

Acura Prime XP 5F Motorized Bed

With Aluminium Sideboards



Features

Head/Foot board	Easily removable head/foot board made of Polypropylene (PP).
Lying Surface	PP injection-moulded removable cover which is easy to clean.
Safety Sideboards	Aluminum Sideboards with dropdown mechanism.
Control Panel	Attendant control panel: Backrest, Knee Rest, Hi-low, Trendelenburg, Reverse Trendelenburg, Auto Contour, Emergency CPR, Lock Button.
Castors	12.5cm, imported castors model, Twin Wheel Diagonal Locking.
Safe working load	200kg

Specification
All sizes in cm

	Length	Depth	Height
Overall dimension	224.1	105.0	44.0 to 77.0
Platform dimension	195.0	88.0	-

Acura Prime XP 5F Motorized Bed

With Aluminium Sideboards

Positions

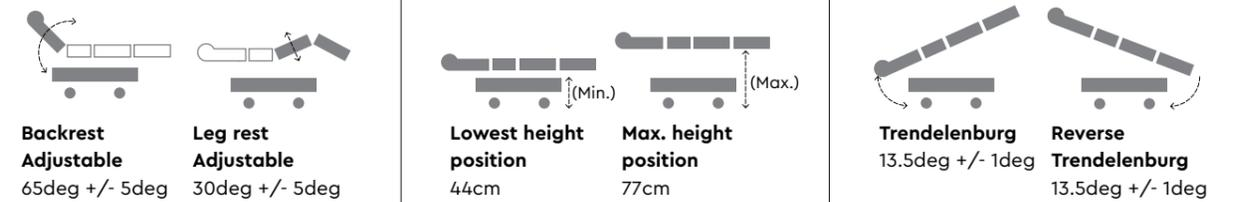

Accessories that comes along with the bed

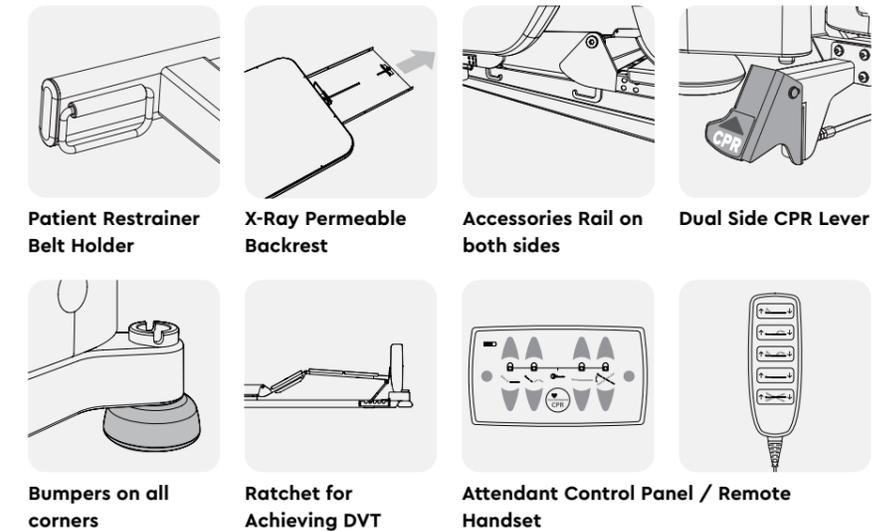

Optional Accessories

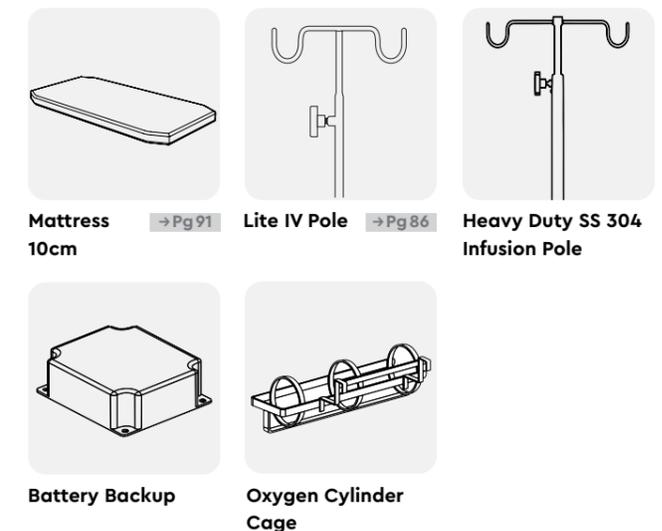

Acura Vital 2F Motorized Bed

With PP Sideboards



Features

Head/Foot board	Easily removable head/foot board made of Polypropylene (PP).
Lying Surface	Polypropylene (PP) injection-moulded removable cover which is easy to clean.
Safety sideboards	Polypropylene (PP) Sideboards with dropdown mechanism.
Control Panel	Dedicated buttons to operate Backrest, Knee Rest.
Castors	12.5cm, imported castors model, Twin Wheel Diagonal Locking.
Safe working load	200kg

Specification
All sizes in cm

	Length	Depth	Height
Overall dimension	224.1	105.0	56.1
Platform dimension	195.0	88.0	-

Acura Vital 2F Motorized Bed

With PP Sideboards

Positions

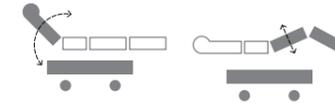

Backrest Adjustable
65deg +/- 5deg

Leg rest Adjustable
30deg +/- 5deg



Fixed Height
56.1cm

Accessories that comes along with the bed

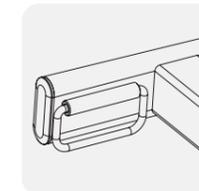

Patient Restrainer Belt Holder

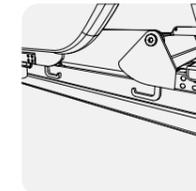

Accessories Rail on both sides



Bumpers on all corners

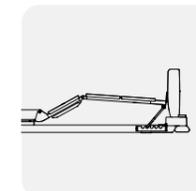

Ratchet for Achieving DVT

Optional Accessories



Mattress 10cm → Pg 91

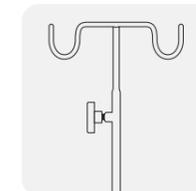

Lite IV Pole → Pg 86



Heavy Duty SS 304 Infusion Pole

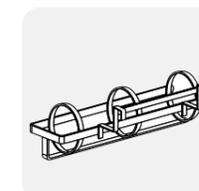

Oxygen Cylinder Cage

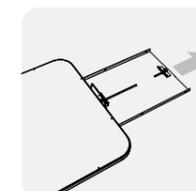

X-Ray Permeable Backrest

Grace 2F Homecare Motorized Bed

With Side Rails



Features

Head/Foot board	Wooden PLT Panels
Lying Surface	Polypropylene (PP) injection-moulded removable cover which is easy to clean.
Safety sideboards	4 independent telescopic side rails provide safety and flexibility.
Control Panel	Dedicated buttons to operate Backrest, Knee Rest.
Features	<ol style="list-style-type: none"> 1. Aesthetic Wooden Finish for Home Environment. 2. Enclosed box design keeps the under structure out of view, to avoid misuse and accidents. 3. Remote spiral wire minimizes entanglement & keeps the area neat. 4. Provision of DVT Position. 5. Entrapment-safe ergonomic design.
Safe working load	200kg

Specification
All sizes in cm

	Length	Depth	Height
Overall dimension	206.5	109.0	35
Platform dimension	195.0	90.0	-

Grace 2F Homecare Motorized Bed

With PP Side Rails

Positions



Backrest Adjustable
65deg +/- 5deg

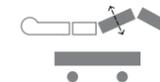

Knee rest Adjustable
30deg +/- 5deg



Fixed Height
35cm

Accessories that comes along with the bed

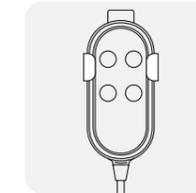

Remote Handset

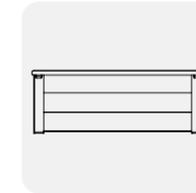

Side Rail

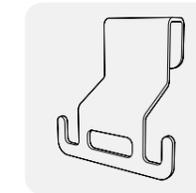

Urine Bag Holder

Optional Accessories

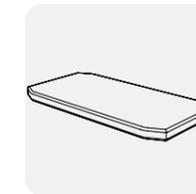

Mattress 10cm [→ Pg 91](#)

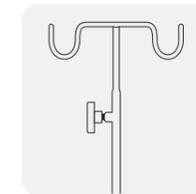

MS Saline Stand with Castors

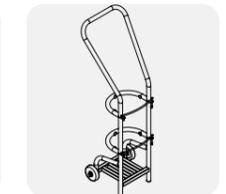

Oxygen Cylinder Trolley [→ Pg 81](#)

Acura Standard 3F Semi-Motorized Bed

With Sideboards



Features

Head/Foot board	Easily removable head/foot board made of Polypropylene (PP).
Lying Surface	Polypropylene (PP) injection-moulded removable cover which is easy to clean.
Sideboard Options	<ol style="list-style-type: none"> 1. Polypropylene (PP) Sideboards with dropdown mechanism 2. Aluminum Sideboards 3. Aluminum Side Rails
Control Panel	Dedicated buttons to operate Backrest, Knee Rest, Hi-low, Auto contour.
TR/ATR	Manual crank operated
Castors	12.5cm, imported castors model, Twin Wheel Diagonal Locking.
Safe working load	200kg

Specification
All sizes in cm

	Length	Depth	Height
Overall dimension	224.1	105.0	49 to 75
Platform dimension	195.0	88.0	-

Acura Standard 3F Semi-Motorized Bed

With Sideboards

Positions

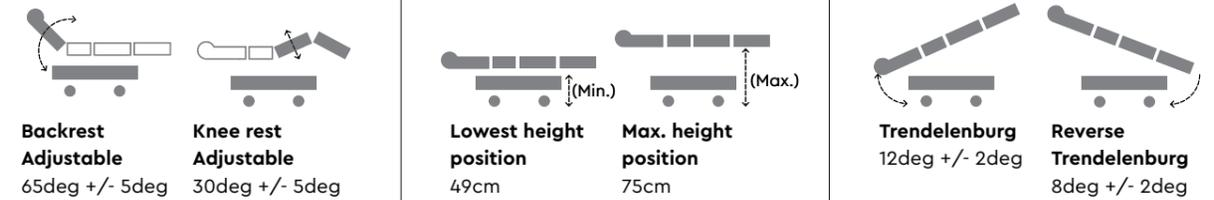

Accessories that comes along with the bed

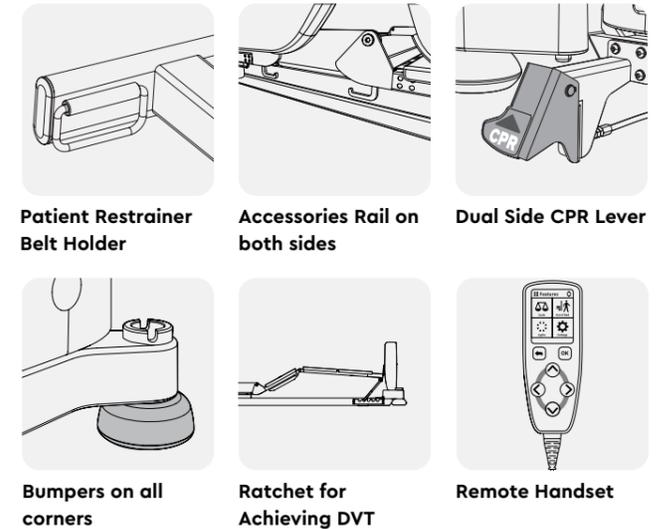

Optional Accessories

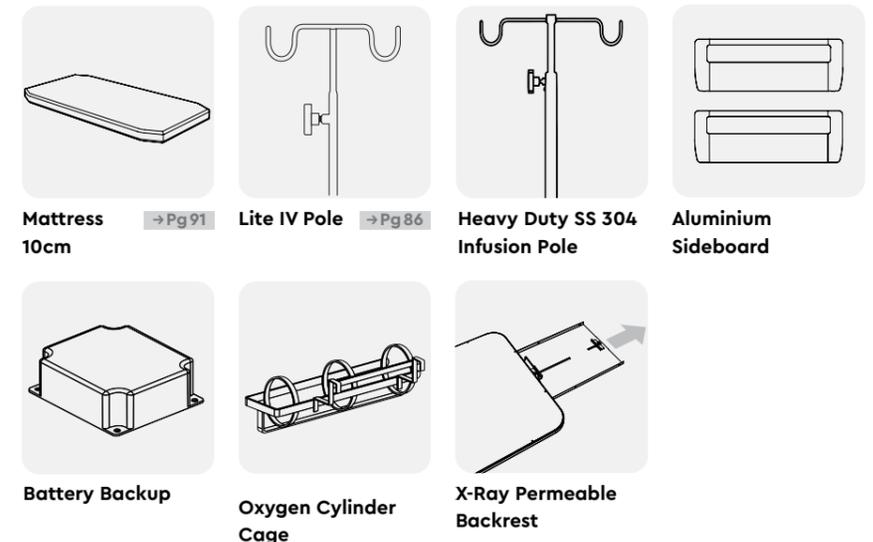

Acura Lite 3F Semi-Motorized Bed

With MS Side Rail



Features

Head/Foot board	Easily removable head/foot board made of Polypropylene (PP).
Lying Surface	MS Sheet lying surface which is easy to clean.
Sideboard Options	MS Side Rail with collapsible mechanism.
Control Panel	Dedicated buttons to operate Backrest, Knee Rest, Hi-low, Auto contour.
TR/ATR	Manual crank operated
Castors	12.5cm, imported castors model, Single Wheel Diagonal Locking.
Safe working load	200kg

Specification
All sizes in cm

	Length	Depth	Height
Overall dimension	224.1	105.0	49.8 to 75.8
Platform dimension	195.0	88.0	-

Acura Lite 3F Semi-Motorized Bed

With MS Side Rail

Positions

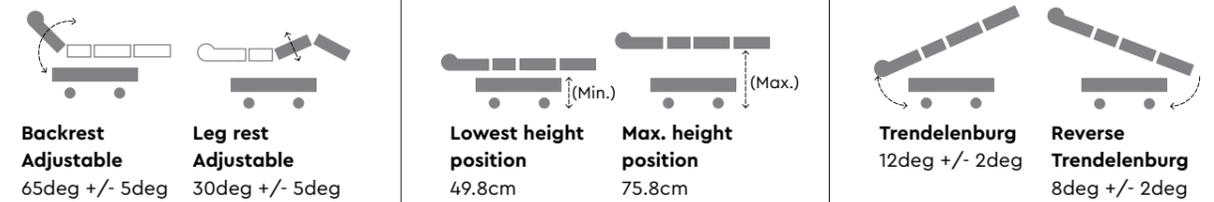

Accessories that comes along with the bed

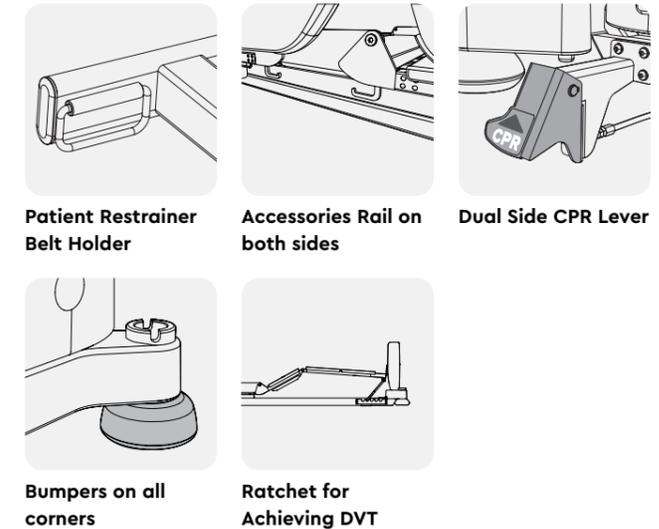

Optional Accessories

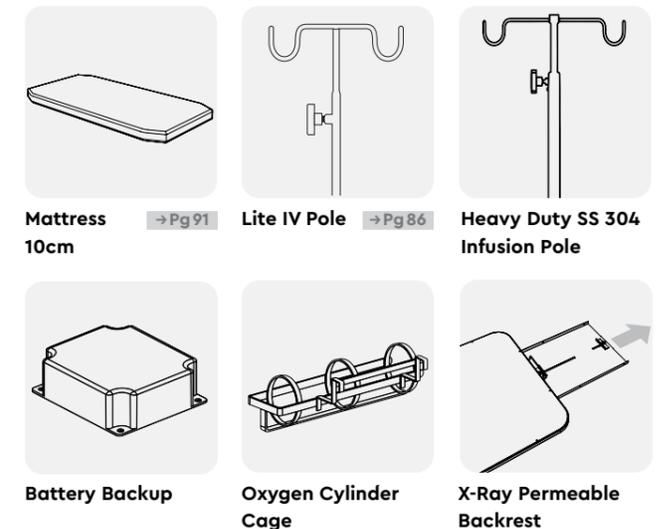

Acura Standard 5F Manual Bed

With Sideboards



Features

Head/Foot board	Easily removable head/foot board made of Polypropylene (PP).
Lying Surface	Polypropylene (PP) injection-moulded removable cover which is easy to clean.
Sideboard Options	1. PP Sideboards with drop down mechanism 2. Aluminum Sideboards 3. Aluminum Side Rails
Manual Crank Operated	Crank handle provided to operate Backrest, Knee Rest, Hi-low, Trendelenburg, Reverse Trendelenburg.
Castors	12.5cm, imported castors model, Twin Wheel Diagonal Locking.
Safe working load	200kg
Upgradability	✓ Upgrade available. Manual to Motorized (3F)

Specification
All sizes in cm

	Length	Depth	Height
Overall dimension	224.1	105.0	49.0 to 75.0
Platform dimension	195.0	88.0	-

Acura Standard 5F Manual Bed

With Sideboards

Positions

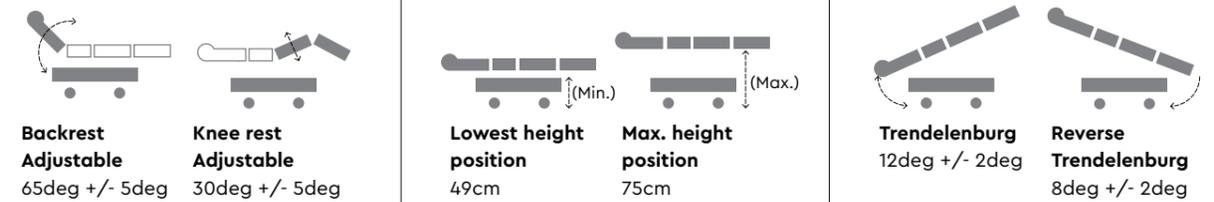

Accessories that comes along with the bed

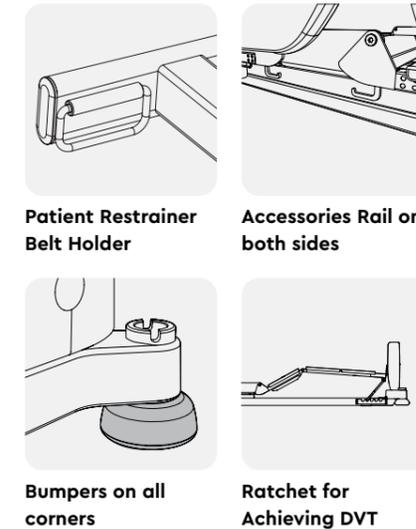

Optional Accessories

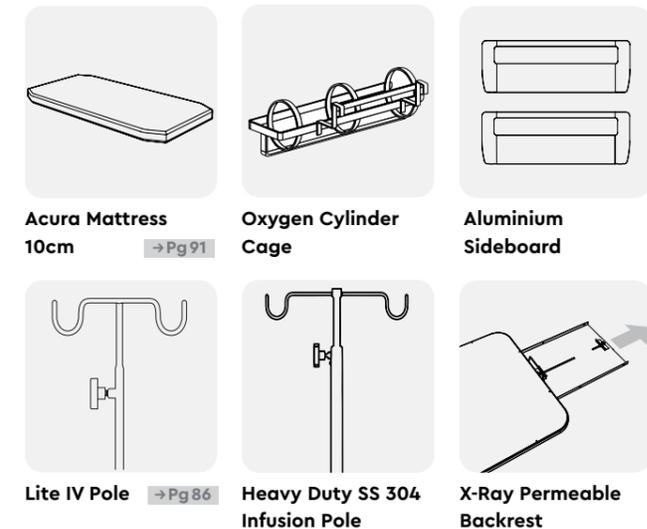

Acura Neo 5F Manual Bed

With Sideboards



Features

Head/Foot board	Easily removable head/foot board made of Polypropylene (PP).
Lying Surface	MS Sheet lying surface which is easy to clean.
Sideboard	PP Sideboards
Manual Crank Operated	Crank handle provided to operate Backrest, Knee Rest, Hi-low, Trendelenburg, Reverse Trendelenburg.
Castors	12.5cm, imported castors model, Single Wheel Diagonal Locking.
Safe working load	200kg
Upgradability	✓ Upgrade available. Manual to Motorized (3F)

Specification
All sizes in cm

	Length	Depth	Height
Overall dimension	224.1	105.0	49.8 to 75.8
Platform dimension	195.0	88.0	-

Acura Neo 5F Manual Bed

With Sideboards

Positions

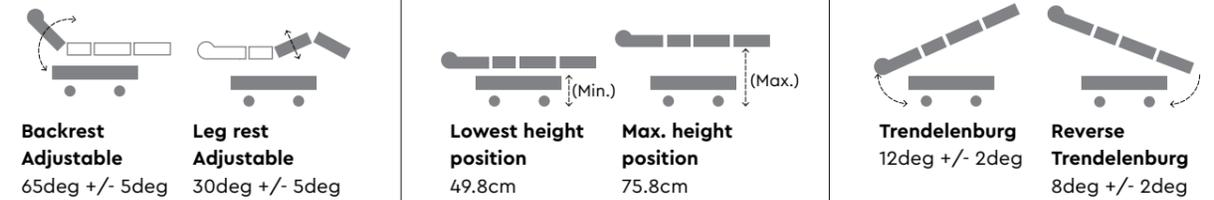

Accessories that comes along with the bed

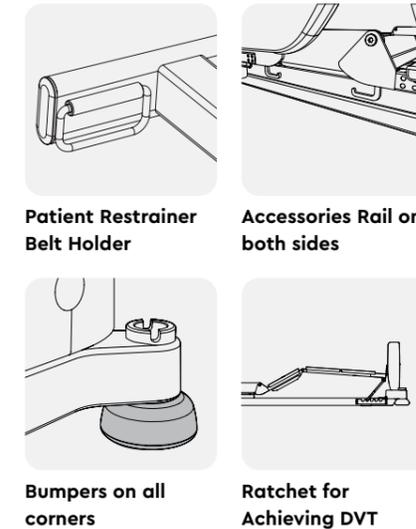

Optional Accessories

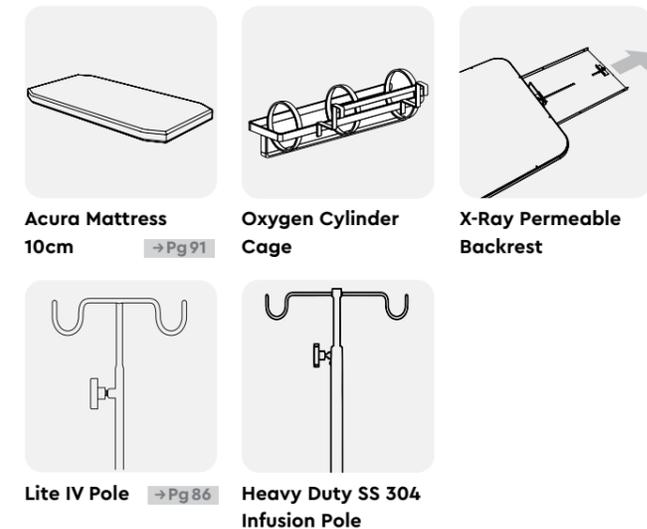

Acura Lite 5F Manual Bed

With MS Side Rails



DESIGN REGISTERED

Features		
Head/Foot board	Easily removable head/foot board made of Polypropylene (PP).	
Lying Surface	MS Sheet lying surface which is easy to clean.	
Sideboard	MS Side Rails	
Manual Crank Operated	Crank handle provided to operate Backrest, Knee Rest, Hi-low, Trendelenburg, Reverse Trendelenburg.	
Castors	12.5cm, imported castors model, Single Wheel Diagonal Locking.	
Safe working load	200kg	
Upgradability	X Non-upgradable	

Specification

All sizes in cm

	Length	Depth	Height
Overall dimension	224.1	105.0	49.8 to 75.8
Platform dimension	195.0	88.0	-

Acura Lite 5F Manual Bed

With MS Side Rails

Positions

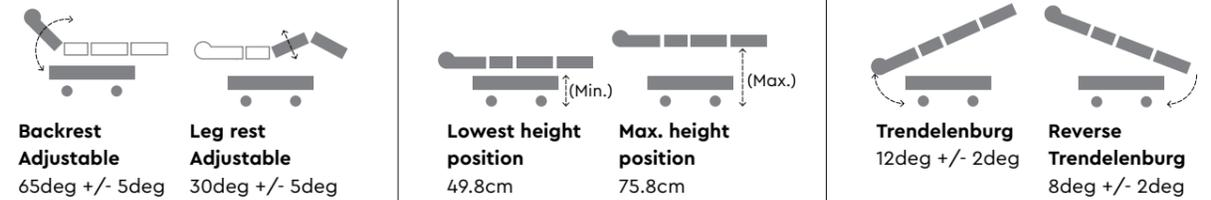

Accessories that comes along with the bed

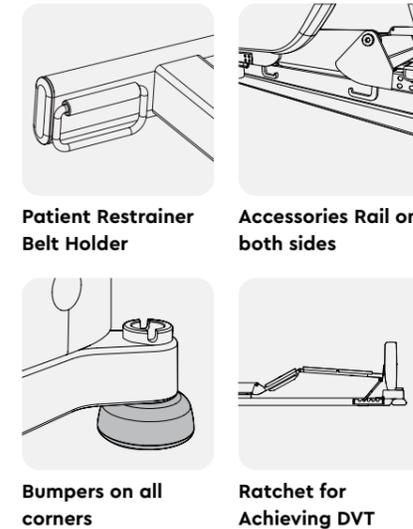

Optional Accessories

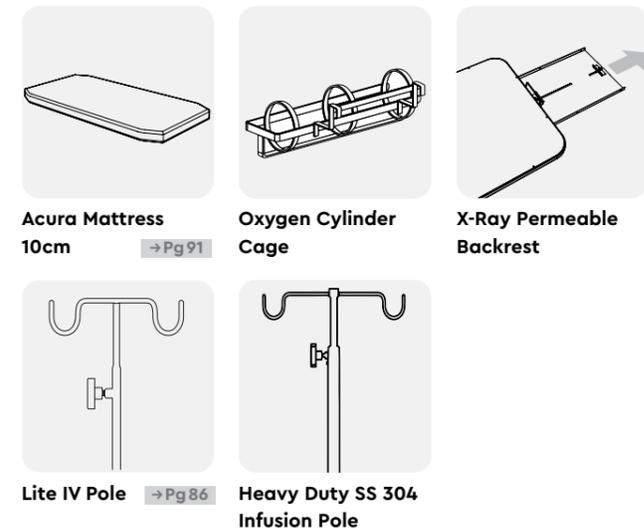

Acura Vital 2F Manual Bed

With PP Sideboards



Features

Head/Foot board	Easily removable head/foot board made of Polypropylene (PP).
Lying Surface	Polypropylene (PP) injection-moulded removable cover which is easy to clean.
Sideboard	PP Sideboards with dropdown mechanism.
Manual Crank Operated	Crank handle provided to operate Backrest and Knee Rest.
Castors	12.5cm, imported castors model, Twin Wheel Diagonal Locking.
Safe working load	200kg
Upgradability	✓ Upgrade available. Manual to Motorized (2F)

Specification
All sizes in cm

	Length	Depth	Height
Overall dimension	224.1	105.0	56.1
Platform dimension	195.0	88.0	-

Acura Vital 2F Manual Bed

With PP Sideboards

Positions

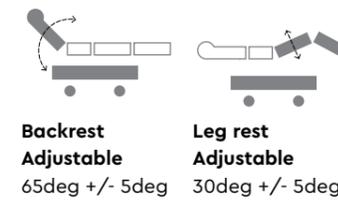

Accessories that comes along with the bed

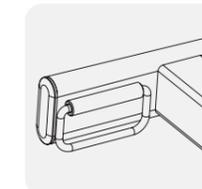

Patient Restrainer Belt Holder

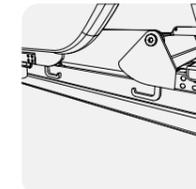

Accessories Rail on both sides



Bumpers on all corners

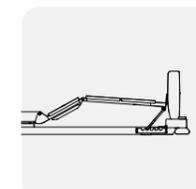

Ratchet for Achieving DVT

Optional Accessories



Acura Mattress 10cm → Pg 91

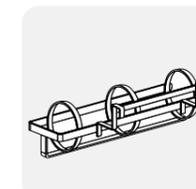

Oxygen Cylinder Cage



X-Ray Permeable Backrest

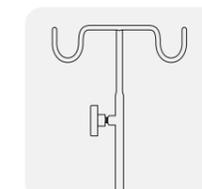

Lite IV Pole → Pg 86

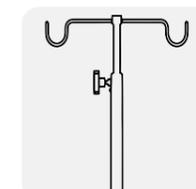

Heavy Duty SS 304 Infusion Pole

Ayush Plus Lite Fowler PP Bed



Positions

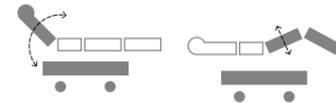

Backrest Adjustable
70deg +/- 2deg

Knee rest Adjustable
24deg +/- 2deg

Accessories that comes along with the bed

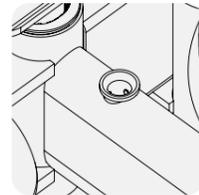

Provision for IV Pole on all corners

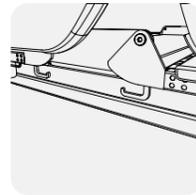

Accessories Rail on both sides

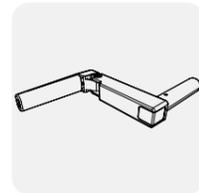

Extra crank handle

Optional Accessories



Mattress 7.5cm [→Pg 86](#)

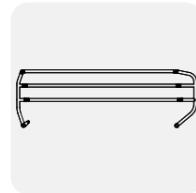

Side rail covering 2/3rd of side rails

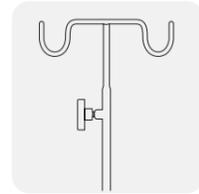

Lite IV pole [→Pg 83](#)

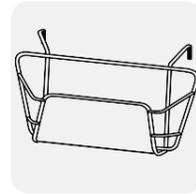

Chart holder

Features

Head/Foot board	Easily removable board made of Polypropylene (PP).
Lying Surface	MS Mild Steel
Manual Crank Handle	Single removable crank handle is provided with 2 lead screws for backrest and knee rest function.
Castors	12.5cm, Single wheel diagonal locking.
Safe working load	135kg

Specification

All sizes in cm	Length	Depth	Height
Overall dimension	214.5	99.0	56.0
Platform dimension	208.5	90.0	-

Ayush Plus Lite Fowler SSPLT Bed



Positions

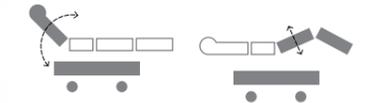

Backrest Adjustable
70deg +/- 2deg

Knee rest Adjustable
24deg +/- 2deg

Accessories that comes along with the bed

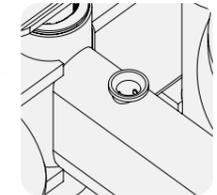

Provision for IV Pole on all corners

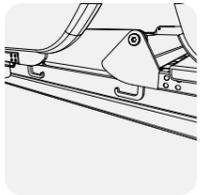

Accessories Rail on both sides

Features

Head/Foot board	Easily removable board made of Polypropylene (PP).
Lying Surface	MS Mild Steel
Manual Crank Handle	Single removable crank handle is provided with 2 lead screws for backrest.
Castors	12.5cm, Single wheel diagonal locking.
Safe working load	135kg

Specification

All sizes in cm	Length	Depth	Height
Overall dimension	214.0	99.0	55.9
Platform dimension	207.5	90.0	-

Optional Accessories

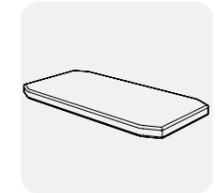

Mattress 7.5cm [→Pg 91](#)

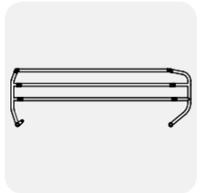

Side rail covering 2/3rd of side rails

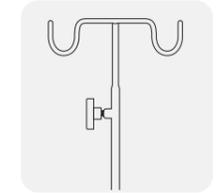

Lite IV pole [→Pg 86](#)



Chart holder

Ayush Lite Fowler

MS Bed



Positions

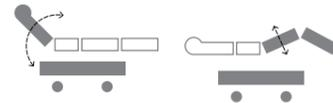

Backrest Adjustable
70deg +/- 2deg

Knee rest Adjustable
24deg +/- 2deg

Accessories that comes along with the bed

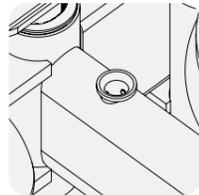

Provision for IV Pole on all corners

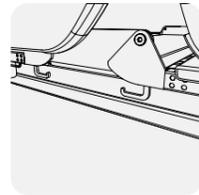

Accessories Rail on both sides

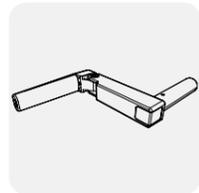

Extra crank handle

Optional Accessories



Mattress 7.5cm [→ Pg 91](#)

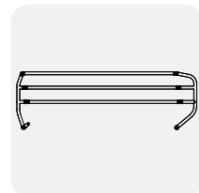

Side rail covering 2/3rd of side rails

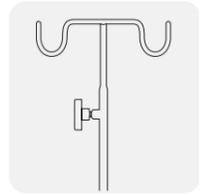

Lite IV pole [→ Pg 86](#)



Chart holder

Features

Head/Foot board	Board made of MS vertical pipes.
Lying Surface	MS Mild Steel
Manual Crank Handle	Single removable crank handle is provided with 2 lead screws for backrest.
Castors	12.5cm, Single wheel diagonal locking.
Safe working load	135kg

Specification

All sizes in cm	Length	Depth	Height
Overall dimension	222.1	92.2	61.1
Platform dimension	207.5	90.0	-

Ayush Plus Lite Semi Fowler

PP Bed



Positions

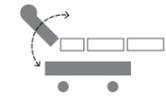

Backrest Adjustable
70deg +/- 2deg

Accessories that comes along with the bed

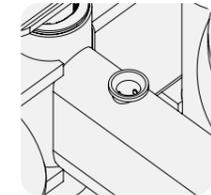

Provision for IV Pole on all corners

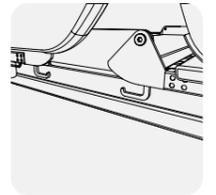

Accessories Rail on both sides

Features

Head/Foot board	Easily removable board made of Polypropylene (PP).
Lying Surface	MS Mild Steel
Manual Crank Handle	Single crank handle is provided with 1 lead screws for backrest.
Castors	12.5cm, Single wheel diagonal locking.
Safe working load	135kg

Specification

All sizes in cm	Length	Depth	Height
Overall dimension	214.5	99.0	56.0
Platform dimension	207.5	90.0	-

Optional Accessories

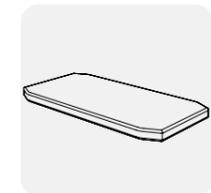

Mattress 7.5cm [→ Pg 91](#)

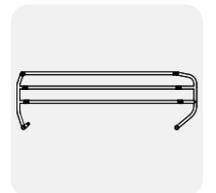

Side rail covering 2/3rd of side rails

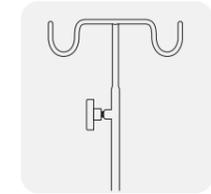

Lite IV pole [→ Pg 86](#)

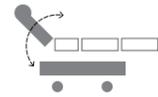

Chart holder

Ayush Plus Lite Semi Fowler SSPLT Bed



Positions



Backrest Adjustable
70deg +/- 2deg

Accessories that comes along with the bed

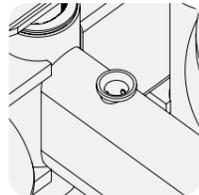

Provision for IV Pole on all corners

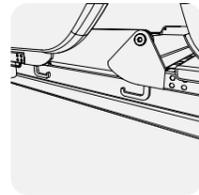

Accessories Rail on both sides

Optional Accessories

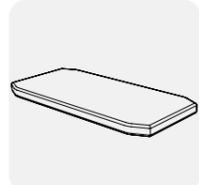

Mattress 7.5cm [→Pg 91](#)

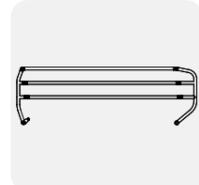

Side rail covering 2/3rd of side rails

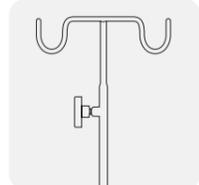

Lite IV pole [→Pg 86](#)



Chart holder

Features

Head/Foot board	Easily removable Board made of SS bow with PLT laminate at centre.
Lying Surface	MS Mild Steel
Manual Crank Handle	Single crank handle is provided with 1 lead screws for backrest.
Castors	12.5cm, Single wheel diagonal locking.
Safe working load	135kg

Specification

All sizes in cm	Length	Depth	Height
Overall dimension	214.0	91.2	55.9
Platform dimension	207.5	90.0	-

Ayush Lite Semi Fowler MS Bed



Positions

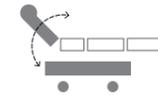

Backrest Adjustable
70deg +/- 2deg

Accessories that comes along with the bed

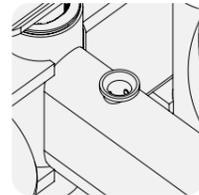

Provision for IV Pole on all corners

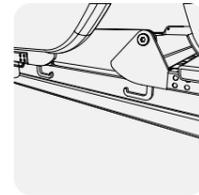

Accessories Rail on both sides

Features

Head/Foot board	Board made of MS vertical pipe.
Lying Surface	MS Mild Steel
Manual Crank Handle	Single crank handle is provided with 1 lead screws for backrest.
Castors	12.5cm, Single wheel diagonal locking.
Safe working load	135kg

Specification

All sizes in cm	Length	Depth	Height
Overall dimension	222.1	92.2	61.1
Platform dimension	207.5	90.0	-

Optional Accessories



Mattress 7.5cm [→Pg 91](#)

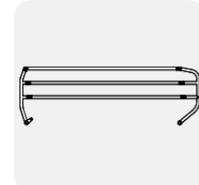

Side rail covering 2/3rd of side rails

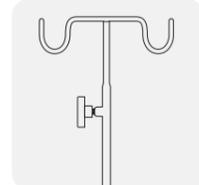

Lite IV pole [→Pg 86](#)



Chart holder

Ayush Plus Lite Sheet

SSPLT Bed



Accessories that comes along with the bed

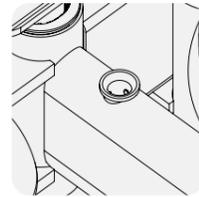

Provision for IV Pole on all corners

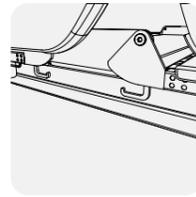

Accessories Rail on both sides

Optional Accessories

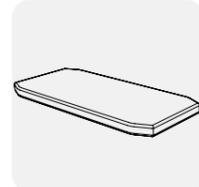

Mattress 7.5cm [→Pg 91](#)

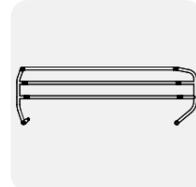

Side rail covering 2/3rd of side rails

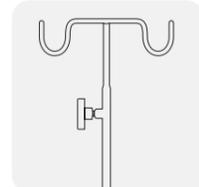

Lite IV pole [→Pg 86](#)



Chart holder

Features

Head/Foot board	Stainless Steel(SS) Bow with Laminate at centre, and easily removable boards.
Lying Surface	MS Mild Steel
Safe working load	135kg

Specification

All sizes in cm	Length	Depth	Height
Overall dimension	199.6	91.2	56.4
Platform dimension	198.4	90.0	-

Ayush Lite Sheet

MS Bed



Accessories that comes along with the bed

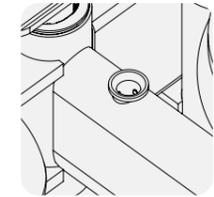

Provision for IV Pole on all corners

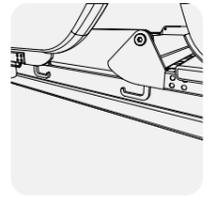

Accessories Rail on both sides

Features

Head/Foot board	Board made of MS vertical pipe.
Lying Surface	MS Mild Steel
Safe working load	135kg

Specification

All sizes in cm	Length	Depth	Height
Overall dimension	200.3	91.4	61.4
Platform dimension	190.0	90.0	-

Optional Accessories



Mattress 7.5cm [→Pg 91](#)

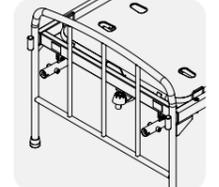

Mosquito Net Pole

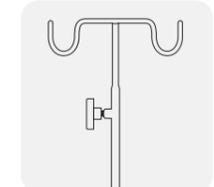

Lite IV pole [→Pg 86](#)



Chart holder

Ayush Lite Attendant MS Bed



Features

Head/Foot board Board made of MS vertical pipe.

Lying Surface MS Mild Steel

Safe working load 135kg

Specification

All sizes in cm

	Length	Depth	Height
Overall dimension	202.5	76.0	55.0
Platform dimension	194.2	76.0	-

Optional Accessory

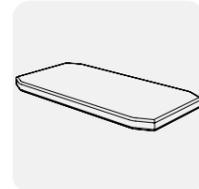

Mattress [→Pg 91](#)
10cm

Couch

Page
52 — 54 **Motorized
Range**

Page
55 — 56 **Manual
Range**



Repos Procedure Couch

With Accessories



DESIGN REGISTERED

Features

Access	360° access to patients helps increase interaction and comfort. 360° rotating calf rest is provided with height-adjustable lithotomy rod.
Lying Surface	The lying surface on the chair is made of Vacuum foam for easy cleaning, along with an SS collection bowl.
SS Collection	SS collection bowl is provided.
Coating	Antimicrobial powder coating for bacterial protection.
Optional	Doctor stool is an optional accessory that can be a snap-fitted on the chair for basic patient check-up.
Control Panel	Pendant control panel: Backrest, Pelvic, Hi-Low, Trendelenburg.
Safe working load	135kg

Specification	Length	Depth	Height
All sizes in cm			
Overall dimension	157.4	94.2	60.0 to 85.0

Positions

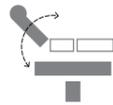

Backrest Adjustable
65deg +/- 5deg

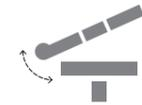

Trendelenburg
15deg +/- 2deg



Lowest height position
60cm



Max. height position
85cm



Pelvic Tilt
15deg +/- 2deg

Optional Accessories



Single Step Stool
→ Pg 83



Tissue Roll Holder



Head Cushion



Doctor's Stool

Repos Gynaec Couch

With Accessories



DESIGN REGISTERED

Features

Access	360° access to patients helps increase interaction and comfort. 360° rotating calf rest is provided with height-adjustable lithotomy rod.
Lying Surface	The lying surface on the chair is made of Vacuum foam for easy cleaning, along with an SS collection bowl.
SS Collection	SS collection bowl is provided.
Coating	Antimicrobial powder coating for bacterial protection.
Optional	Doctor stool is an optional accessory that can be a snap-fitted on the chair for basic patient check-up.
Control Panel	Pendant control panel: Backrest, Hi-Low.
Safe working load	135kg

Specification	Length	Depth	Height
All sizes in cm			
Overall dimension	157.4	94.2	60.0 to 85.0

Positions

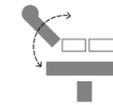

Backrest Adjustable
65deg +/- 5deg



Lowest height position
60cm



Max. height position
85cm

Optional Accessories



Single Step Stool
→ Pg 83



Tissue Roll Holder

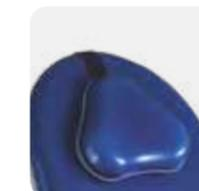

Head Cushion



Doctor's Stool

Repos Physical Examination Table

With Accessories



DESIGN REGISTERED

Features

Access	360° access to patients helps increase interaction and comfort.
Lying Surface	The lying surface on the chair is made of vaccum foam for easy cleaning.
Storage	Compact Storage available.
Coating	Antimicrobial powder coating for bacterial protection.
Control Panel	Pendant control panel: Backrest, Hi-Low.
Safe Working Load	135kg

Specification	Length	Depth	Height
Overall dimension	200.2	66.5	81.2

Positions

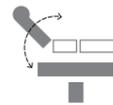

Backrest Adjustable
65deg +/- 5deg

Optional Accessories



Single Step Stool
→ Pg 83



Tissue Roll Holder



Head Cushion



Chart holder

Revive Full Storage Couch



Features

Head Rest	Head rest assisted on gas lift upto 30°.
Accessory	Folding blood pressure tray is available at the head side of the couch.
Levelers	Levelers are provided for the base support of examination table.
Drawers and Cabinets	Couch has 3 drawers at the top, 3 cabinet at the bottom, with an inbuilt sliding step stool.

Specification	Length	Depth	Height
Overall dimension	197.4	56.0	80.5

Positions

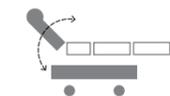

Backrest Adjustable
65deg +/- 5deg

Examination Table on RTC



Features

Design	Examination table with sturdy structure made of MS.
Head Rest	Headrest assisted on ratchet upto 30°.
Safe Working Load	135kg

Specification All sizes in cm	Length	Depth	Height
Overall dimension	183.0	60.0	85.0

Positions

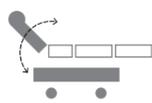

Headrest Adjustable 30deg

Optional Accessories



Single Step Stool
→Pg 83



2 Section Mattress 3cm

Examination Table on RTC — Gynaec



Features

Design	Examination table with sturdy structure made of MS.
Head Rest	Headrest assisted on ratchet upto 30°.
Knee Rest	Knee rest section is provided with a cutout and SS collection tray is provided.
Calf Rest	360° rotating calf rest is provided with height-adjustable lithotomy rod.
Safe Working Load	135kg

Specification All sizes in cm	Length	Depth	Height
Overall dimension	206.5	85.0	85.0

Positions



Headrest Adjustable 30deg

Optional Accessories



Single Step Stool
→Pg 83



2 Section Mattress 3cm

Infant Crib & Trolley



Page 58 — 59

Birthing Bed



Page 60 — 63

Pediatric Bed



Features

Design	Single section flat bed with grille frame on four sides.
Side Rails	Full length dropdown side rails for protection.
Legs	Legs are fitted with rubber shoes.
Safe working load	100kg

Specification

All sizes in cm	Length	Depth	Height
Overall dimension	157.2	83.9	121.8

Optional Accessories



Pediatric Mattress
7.5cm [→ Pg 94](#)

Crib on Trolley



Features

Design	Wire mesh frame designed to accommodate the baby and provide visibility and ventilation.
Castors	12.5cm diagonal locking castors.
Safe working load	20kg

Optional Accessories

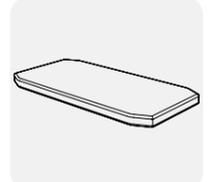

Crib Mattress
5cm [→ Pg 94](#)

Specification

All sizes in cm	Length	Depth	Height
Overall dimension	89.2	53.6	100.8

Crib on Bed With PP Sideboard



Features

Design	Wire mesh frame designed to accommodate the baby and provide visibility and ventilation. Suitable to fit in on foot board end of the bed.
Compatible with	Acura Range & Ayush Plus
Safe working load	20kg

Optional Accessories



Crib Mattress
5cm [→ Pg 94](#)

Specification

All sizes in cm	Length	Depth	Height
Overall dimension	90.8	41.6	78.4

Solace LDRP Bed



Features

Head/Foot board	Easily removable Head/Foot board made of Polypropylene (PP).
Lying Surface	3 section lying surface made in compact laminate.
Design	Backrest – Tilting, Pelvic – Fixed, Leg rest – Sliding.
Sideboards	PP Sideboards with smooth dropdown mechanism.
Remote Handset	2 Nos. – 1 Attendant + 1 Patient (optional) Patient – Backrest and Height adjustment provision Attendant – Backrest, TR, Height adjustment, Auto CPR and UBL.
Castors	12.5cm Twin wheel central locking with two levers on sides.
Safe working load	250kg
Patient load	185kg

Specification
All sizes in cm

	Length	Depth	Height
Overall dimension	214.0	101.0	50.0 to 85.0

Solace LDRP Bed

Other Features

- ✓ Handgrip: 2 Nos (Left +Right)
- ✓ Calf Rests: 2 Nos
- ✓ Foot rest at legside: below bowl, for doctors
- ✓ Bowl: 1 Nos, with 10L capacity
- ✓ Corner bumpers: total 4 Nos, located at all corners
- ✓ Motorized backrest height & Trendelenburg
- ✓ ATR specially removed to increase safety
- ✓ Underbed light
- ✓ Manual & Electric CPR 2 Nos, located at each side of back rest
- ✓ Lite IV pole provision: 4 Nos, located at 4 corners
- ✓ Heavy duty IV pole provision: 4 Nos, located at 4 corners
- ✓ Base frame cover: 4 Nos, independently placed at 4 corners
- ✓ Retractable leg rest for quick conversion

Positions



Accessories that comes along with the bed



Optional Accessories

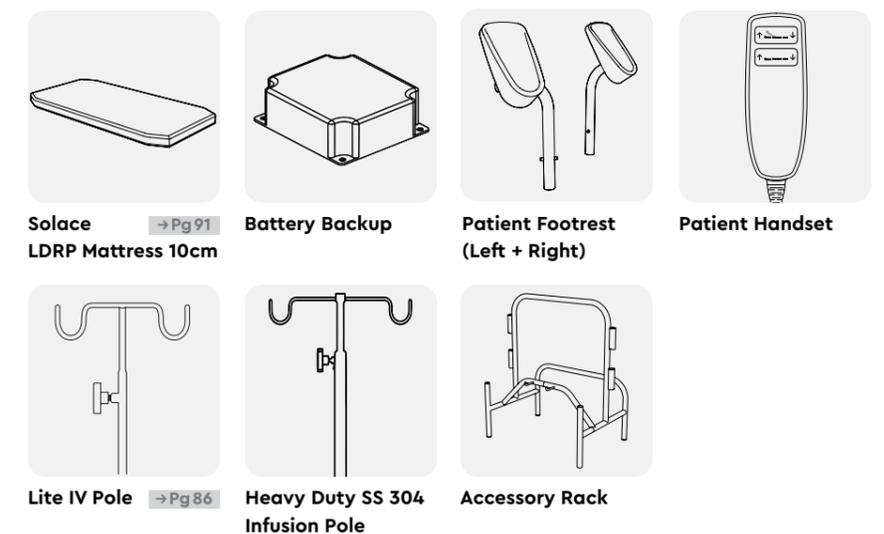

Solace Lite LDRP Bed



Features

Head/Foot board	Easily removable Headboard made of Polypropylene (PP). Foot board is not provided.
Lying Surface	3 section lying surface, Pelvic & Leg rest made in compact laminate, Backrest made in MS Sheet.
Design	Backrest - Tilting, Pelvic - Fixed, Leg rest - Sliding.
Sideboards	PP Sideboards with smooth dropdown mechanism.
Remote Handset	2 Nos. - 1 Attendant + 1 Patient (optional) Patient - Backrest and Height adjustment provision Attendant - Backrest, TR, Height adjustment, Auto CPR and UBL.
Castors	12.5cm Single Wheel Diagonal Locking .
Safe working load	250kg
Patient load	185kg

Specification
All sizes in cm

	Length	Depth	Height
Overall dimension	214.0	101.0	50.0 to 85.0

Solace Lite LDRP Bed

Other Features

- ✓ Handgrip: 2 Nos (Left +Right)
- ✓ Calf Rests: 2 Nos
- ✓ Bowl: 1 Nos, with 10L capacity

- ✓ Corner bumpers: total 2 Nos, located at head-side
- ✓ Motorized backrest height & Trendelenburg
- ✓ ATR specially removed to increase safety
- ✓ Underbed light

- ✓ Manual & Electric CPR: 2 Nos, located at each side of back rest
- ✓ Lite IV pole provision: 2 Nos, located at head side
- ✓ Heavy duty IV pole provision: 4 Nos, located at 4 corners
- ✓ Retractable leg rest for quick conversion

Positions

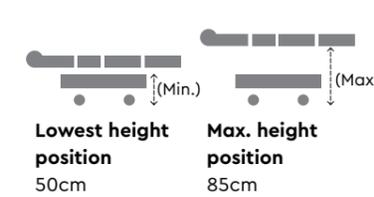
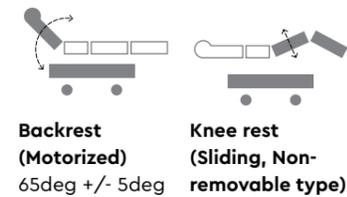

Accessories that comes along with the bed



Optional Accessories



Rapid NEO ERT

→Pg73



Locker

Page
66 — 68



Patient Mobility

Page
72 — 74



Over Bed Table

Page
69 — 71



Medical Cart

Page
73 — 74



Aptis Locker

2 Drawer 1 Cabinet



Features

Material	Top made is ABS		
Handle	U-Shaped Metal handle for mobility.		
Drawer and Cabinet	Lock facility in drawer and cabinet.		
Castors	5cm diameter castors with front locking.		

Specification
All sizes in cm

	Length	Depth	Height
Overall dimension	49.0	41.0	88.1

Aptis Locker

1 Drawer 1 Cabinet



Features

Material	Top made is ABS		
Handle	U-Shaped Metal handle for mobility.		
Drawer and Cabinet	Lock facility in drawer and cabinet.		
Castors	5cm diameter castors with front locking.		

Specification
All sizes in cm

	Length	Depth	Height
Overall dimension	49.0	41.0	94.7

Aptis Locker

1 Cabinet



Features

Material	Top made is ABS		
Handle	U-Shaped Metal handle for mobility.		
Drawer and Cabinet	Lock facility in drawer and cabinet.		
Castors	5cm diameter castors with front locking.		

Specification
All sizes in cm

	Length	Depth	Height
Overall dimension	49.0	41.0	94.75

Delux Locker

1 Drawer 1 Cabinet



Features

Material	SS 304 make top
Drawer and Cabinet	Lock facility in drawer and cabinet.
Castors	5cm diameter castors with front locking.

Specification

All sizes in cm	Length	Depth	Height
Overall dimension	40.2	42.2	84.0

Simple Locker

1 Cabinet



Features

Material	SS 304 make top
Drawer and Cabinet	Lock facility in drawer and cabinet.

Specification

All sizes in cm	Length	Depth	Height
Overall dimension	40.2	40.4	83.5

Adeo OBT on Gas Lift Split Type



DESIGN REGISTERED

Features

Material	Compact laminate along with tilting top.
Height	Height adjustable on gas lift.
Coating	Antimicrobial powder coated.
Castors	5cm diameter castors with diagonal locking.
Safe working load at Top	20kg

Specification

All sizes in cm

	Length	Depth	Height
Overall dimension	89.65	39.5	79.9 to 109.2

Aptis OBT on Gas Lift



Features

Material	Compact laminate along with tilting top.
Height	Height adjustable on gas lift.
Coating	Antimicrobial powder coated.
Castors	5cm diameter castors with diagonal locking.
Safe working load at Top	20kg

Specification

All sizes in cm	Length	Depth	Height
Overall dimension	89.65	39.5	80.75 to 109.74

Ayush Fixed Height OBT



DESIGN REGISTERED

Features

Material	MDF with PVC membrane having thickness of 1.8cm.
Castors	5cm diameter castors with diagonal locking.
Safe working load at Top	20kg

Specification

All sizes in cm

	Length	Depth	Height
Overall dimension	105.0	38.0	95.0

Aptis OBT on Crank



Features

Material	Compact laminate along with tilting top.
Height	Height adjustable on crank.
Coating	Antimicrobial powder coated.
Castors	5cm diameter castors with diagonal locking.
Safe working load at Top	20kg

Specification

All sizes in cm	Length	Depth	Height
Overall dimension	89.9	55.5	97.0 to 117.0

Stretcher on Trolley



DESIGN REGISTERED

Features

Design	<ul style="list-style-type: none"> MS stretcher on trolley with removable stretcher Contoured stretcher top provides safety to patient handling
Accessory	Provision for providing IV pole on diagonal locking castors.
Castors	20cm diameter castors with diagonal locking.
Safe working load	135kg

Specification
All sizes in cm

	Length	Depth	Height
Overall dimension	200.5	66.6	83.0
Platform dimension	200.5	58.5	

Rapid Neo ERT



DESIGN REGISTERED

Features

Design	Removable stretcher, fully x-ray permeable, made of compact laminate with sliding x-ray tray.
Accessory	<ul style="list-style-type: none"> Height adjustable IV Pole, oxygen cylinder cage and patient safety strap is provided Utility tray available for storage Bumpers on all corners for ease in movement
Coating	Antimicrobial powder coating to prevent bacterial protection.
Castors	12.5cm castors model, single wheel diagonal locking.
Safe Working Load	140kg
Optional Feature	<ul style="list-style-type: none"> Trendelenburg 15° & Reverse Trendelenburg 8° on gas spring mechanism. Also available in rapid ERT model without TR ATR function

Specification

All sizes in cm

	Length	Depth	Height
Overall dimension	213.9	93.6	70.0 to 108.0
Platform dimension	206.4	63.0	

Positions

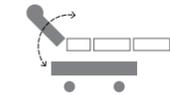

Backrest Adjustable
70deg +/- 2deg

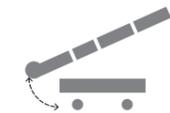

Trendelenburg
15deg +/- 2deg

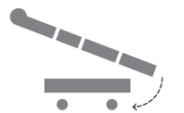

Reverse Trendelenburg
8deg +/- 2deg



Lowest height position
68cm

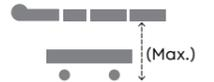

Max. height position
105.5cm

Accessories that comes along with the bed



ERT Mattress 5cm

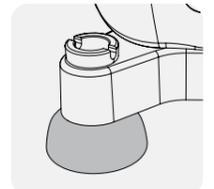

Bumpers on all corners

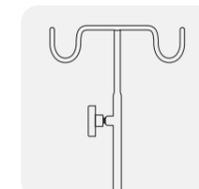

Lite IV Pole →Pg 70

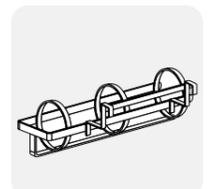

Oxygen Cylinder Cage

Folding WheelChair Cushion



Features

Design	<ul style="list-style-type: none"> • Chrome-finished foldable wheelchair with cushion type seat and flexible back. • Foldable footrest with up, down & swivel type adjustment handling. • Leatherite strap is provided at the calf rest section. File holder at the back of the wheelchair.
Wheels	<ul style="list-style-type: none"> • Rear mag wheels are 24 inches, made of solid rubber • Front mag wheels are 8 inches, made of solid rubber
Safe working load	100kg

Specification
All sizes in cm

	Length	Depth	Height
Overall dimension	79.0	60.0	87.0

Agilo Medicine Cart



Features

Drawer Configuration	6 Small Drawer: 390(L)x600(W)x71(H)mm 1 Large Drawer: 390(L)x600(W)x227(H)mm
Castors	125mm Single wheel Front locking castors.
Construction	MS CRCA powder coated, with Sheet thickness of 1.2mm, and ABS Top tray.
Safe working load	47kg

Specification

All sizes in cm	Length	Depth	Height
Overall dimension	99.6	62.5	155.0

Other Features

- ✓ Tilt Bins for storage
- ✓ Bridge Shelf for storage
- ✓ Key Lock
- ✓ Medicine Bins
- ✓ 4TPE Bumpers
- ✓ Utility Tray
- ✓ Document Holder
- ✓ Waste Bin
- ✓ Writing pad Drawer
- ✓ Acrylic Separators
- ✓ Needle dispenser
2 Nos
- ✓ Drawer labels
- ✓ Anti-tilt mechanism
- ✓ Customizable

Optional Accessories

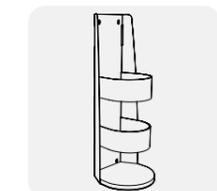

Oxygen Cylinder Cage

Agilo Emergency Cart



Features

Drawer Configuration	2 Small Drawer: 390(L)x600(W)x71(H)mm 2 Medium Drawer: 390(L)x600(W)x149(H)mm 1 Large Drawer: 390(L)x600(W)x227(H)mm
Castors	125mm Single wheel Front locking castors.
Construction	MS CRCA powder coated, with Sheet thickness of 1.2mm, and ABS Top tray.
Safe working load	55kg

Specification

All sizes in cm	Length	Depth	Height
Overall dimension	103.7	67.2	143.5

Other Features

- ✓ Defibrillator tray
- ✓ Oxygen cylinder case
- ✓ CPR Board
- ✓ Cam Lock + Security Seal: 100 Nos
- ✓ Wire wounder
- ✓ 4TPE Bumpers
- ✓ Utility Tray
- ✓ Document Holder
- ✓ Waste Bin
- ✓ Writing pad Drawer
- ✓ Acrylic Separators
- ✓ Needle dispenser 2 Nos
- ✓ Drawer labels
- ✓ Catheter holder
- ✓ Anti-tilt mechanism
- ✓ Customizable

Optional Accessories

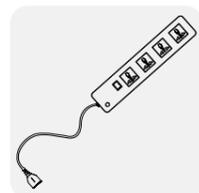

Spike Guard / Extension Board

SS Crash Cart



Features

Shelves	3 shelves made of SS 304.
Oxygen Cylinder Cage	Oxygen cylinder cage available on 5cm dia. castors.
Bins	6 coloured bins available above top shelf.
Drawer Configuration	Two drawer sets of 3 drawers each with central locking
IV Pole	Height-adjustable IV Pole available on cart Safe.
Castors	12.5cm diagonal locking castors.
Safe working load	30kg

Specification

All sizes in cm	Length	Depth	Height
Overall dimension	104.8	47.5	155.5



SS Trolleys & Carts

Page
79 — 81

SS & MS Accessories

Page
82 — 88



Instrument Trolley

Bowl And Bucket / Dressing Trolley



Features

Shelves	2 shelves made of SS 304 with railing on all four corners.
Castors	12.5cm diagonal locking castors.
Bowl and Bucket	Bowl and Bucket with spin section (Bucket is provided with lid)
Safe working load	10kg

Specification

All sizes in cm	Length	Depth	Height
Overall dimension	115.6	53.1	91.5

Instrument Trolley



Features

Shelves	2 shelves made of SS 304 with railing on all four corners.
Castors	12.5cm diagonal locking castors.
Safe working load	10kg

Specification

All sizes in cm	Length	Depth	Height
Overall dimension	77.5	53.1	91.5

Medicine Trolley



Features

Shelves	2 shelves made of SS 304 with railing on all four corners.
Castors	12.5cm diagonal locking castors.
Safe working load	10kg

Specification

All sizes in cm	Length	Depth	Height
Overall dimension	90.2	53.2	91.5

Instrument Cabinet



Features

Make	MS make storage with adjustable shelves and door lock.
Window	Transparent acrylic window on the front and sides of the storewell.

Specification

All sizes in cm	Length	Depth	Height
Overall dimension	91.6	48.6	198.1

Mayo Trolley



Features

Tray	Top tray SS 304 with telescopic tube for smooth height adjustability.
Castors	5cm diagonal castors for easy movement.
Safe working load	20kg

Specification

All sizes in cm	Length	Depth	Height
Overall dimension	50.4	65.0	81.4 to 134.0

Oxygen Cylinder Trolley



Features

Make	MS make trolley with locking rod mechanism.
Castors	10cm diagonal castors for easy movement.
Usage	Suitable for B type oxygen cylinder.

Specification

All sizes in cm	Length	Depth	Height
Overall dimension	41.0	38.8	111.2

Kick Bucket



Features

Design	3 legged single tier basin Removable bowl of SS 202.
Castors	5cm diagonal castors.
Safe working load	10kg

Specification

All sizes in cm	Base Circle Diameter	Height
Overall dimension	51.7	21.0

Basin Stand



Features

Design	4 legged single tier basin Removable bowl of SS 202.
Castors	5cm diagonal castors.
Safe working load	20kg

Specification

All sizes in cm	Base Circle Diameter	Height
Overall dimension	42.5	85.0

Single Step Stool



Features

Design	<ul style="list-style-type: none"> One step stool to support climbing on couch. Step stool is provided with leveller at base.
Make	Top is MS with Rubber Matt to provide good grip.
Safe working load	135kg

Specification

All sizes in cm	Length	Depth	Height
Overall dimension	48.5	35.5	21.0

Double Step Stool



Features

Design	<ul style="list-style-type: none"> Two step stool to support climbing on couch. Step stool is provided with leveller at base.
Make	Top is MS with Rubber Matt to provide good grip.
Safe working load	135kg

Specification

All sizes in cm	Length	Depth	Height
Overall dimension	66.5	48.5	39.3

Square Stool



Features

Design	Fixed height stool without castors.
Castors	SS square top with MS understructure.
Safe working load	135kg

Specification

All sizes in cm	Length	Depth	Height
Overall dimension	41.1	41.1	52.2

3 fold Screen



Features

Design	<ul style="list-style-type: none"> Two foldable frames with one fixed frame. Double layer casement fabric is provided for modesty.
Wheel (optional)	5cm wheel available for easy movement.

Specification

All sizes in cm	Length	Depth	Height
Overall dimension	263.7	64.0	172.0

Round Stool



Features

Design	Height adjustable without castors.
Castors	SS round top with MS understructure.
Safe working load	135kg

Specification

All sizes in cm	Base Circle Diameter	Height
Overall dimension	53.8	47.0 to 65.5

Soil Linen Trolley

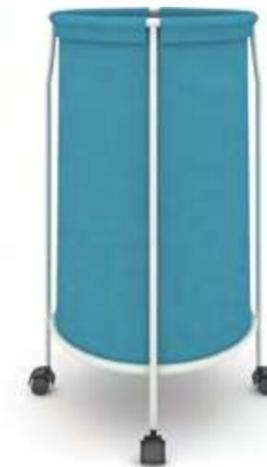

Features

Design	<ul style="list-style-type: none"> MS trolley on 5cm castors for easy movement. Casement fabric provided.
Safe working load	10kg

Specification

All sizes in cm	PCD	Height
Overall dimension	62.5	95.5

Lite IV Pole

Features

Design Completely SS height-adjustable IV Pole with two hooks.



Specification

All sizes in cm	PCD	Height
Overall dimension	25.0	74.3 to 115.0

Infusion Pole

Features

Design Completely SS height-adjustable Infusion Pole with two hooks.



Specification

All sizes in cm	PCD	Height
Overall dimension	36.6	100.7 to 130.0

MS Saline Stand

Features

Design 4 hook completely MS make, 4 pronged height-adjustable saline stand.

Castors 5cm diagonal castors

Safe working load 3kg per hook



Specification

All sizes in cm	Base Diameter	Height
Overall dimension	69.5	156.8 to 212.1

SS Saline Stand

Features

Design 2 hook completely MS make, 5 pronged height-adjustable saline stand.

Castors 5cm diagonal castors

Safe working load 3kg per hook



Specification

All sizes in cm	Base Diameter	Height
Overall dimension	65.2	165.5 to 236.5

SS and MS Side Rails



MS Side Rail

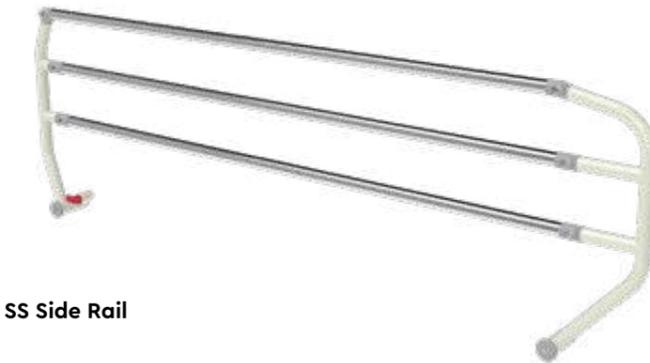

SS Side Rail

Features

Design

- This side rail is available in both MS & SS make.
- This side rail covers 2/3rd of the bed length.
- Pull to turn mechanism is used.

Specification

All sizes in cm

	Length	Depth	Height
Overall dimension	157.0	92.0	53.5

Traction Pulley



Features

- | | |
|--------|--|
| Design | <ul style="list-style-type: none"> Pulley has multiple locking position. Lateral shifting of levels. |
|--------|--|

Safe working load	40kg
-------------------	------

Specification

All sizes in cm	Length	Depth	Height
Overall dimension	98.0	8.0	50.0

Patient Lifting Pole



Features

- | | |
|--------|--|
| Design | Completely MS with height adjustable handgrip. |
|--------|--|

Safe working load	135kg
-------------------	-------

Specification

All sizes in cm	Length	Depth	Height
Overall dimension	133.0	5.0	85.0

Mattress

Page
90 — 96

Chrysalis Mattress



Features

Foam Details	PU Foam with density 40 kg/cubic metre
Design	<ul style="list-style-type: none"> • Four section mattress with straps at foot end. It is water resistant, fire retardant & antimicrobial painted to prevent bacterial growth. • Easy to remove and clean.
Compatibility	All Chrysalis Range of Beds.



All Chrysalis Range

→ Pg 10-19

Specification
All sizes in cm

	Length	Depth	Height
Overall dimension	190.0	84.0	10.0

Acura Mattress



Features

Foam Details	PU Foam with density 40 kg/cubic metre
Design	<ul style="list-style-type: none"> • Single Section Mattress which is water resistant, fire retardant & Antimicrobial painted to prevent bacterial growth. • Easy to remove and clean.
Compatibility	Rapid & Rapid NEO Emergency Recovery Trolley.



Grace 2F Homecare Motorized Bed

→ Pg 28



All Acura Range

Specification
All sizes in cm

	Length	Depth	Height
Overall dimension	195.0	85.3	10.0

4 Section Mattress



Ayush Plus Lite Fowler Bed
→ Pg 40



Ayush Lite Fowler Bed
→ Pg 41

Features

Foam Details PU Foam with density 40 kg/ cubic metre

Design

- 4 Section Mattress which is water resistant, fire retardant & antimicrobial painted to prevent bacterial growth.
- Easy to remove and clean.

Compatibility All Fowler range of beds.

Specification

All sizes in cm	Length	Depth	Height
Overall dimension	196.5	83.0	10.0

Option of 7.5cm Height Mattress is also available

2 Section Mattress



Ayush Plus Lite Semi Fowler Bed
→ Pg 40



Ayush Lite Semi Fowler Bed
→ Pg 41

Features

Foam Details PU Foam with density 40 kg/ cubic metre

Design

- 2 Section Mattress which is water resistant, fire retardant & antimicrobial painted to prevent bacterial growth.
- Easy to remove and clean.

Compatibility All Semi Fowler range of beds.

Specification

All sizes in cm	Length	Depth	Height
Overall dimension	196.5	83.0	10.0

Option of 7.5cm Height Mattress is also available

Single Section Mattress



Ayush Plus Lite Sheet Bed
→ Pg 40



Ayush Lite Sheet Bed
→ Pg 41

Features

Foam Details PU Foam with density 40 kg/ cubic metre

Design

- Single Section Mattress which is water resistant, fire retardant & antimicrobial painted to prevent bacterial growth.
- Easy to remove and clean.

Compatibility All Sheet Range of Beds.

Specification

All sizes in cm	Length	Depth	Height
Overall dimension	190.0	90.0	10.0

Option of 7.5cm Height Mattress is also available

Attendant Bed Mattress



Ayush Lite Attendant Bed
→ Pg 42

Features

Foam Details PU Foam with density 40 kg/ cubic metre

Design

- Single Section Mattress which is water resistant, fire retardant & antimicrobial painted to prevent bacterial growth.
- Easy to remove and clean.

Compatibility Ayush Attendant Bed.

Specification

All sizes in cm	Length	Depth	Height
Overall dimension	188.0	78.0	10.0

Crib Mattress



Crib on Trolley
→ Pg 49

Crib on Bed
→ Pg 49

Features

Foam Details PU Foam with density 40 kg/ cubic metre

Design

- Single Section Mattress which is water resistant, fire retardant & antimicrobial painted to prevent bacterial growth.
- Easy to remove and clean.

Compatibility Crib On Trolley and Crib On Bed.

Specification
All sizes in cm

	Length	Depth	Height
Overall dimension	61.5	31.5	5.0

Pediatric Bed Mattress



Pediatric Bed → Pg 48

Features

Foam Details PU Foam with density 40kg/ cubic metre

Design

- Single Section Mattress which is water resistant, fire retardant & antimicrobial painted to prevent bacterial growth.
- Easy to remove and clean.

Compatibility Pediatric Bed

Specification
All sizes in cm

	Length	Depth	Height
Overall dimension	141.5	78.5	7.5

Examination Table Mattress



Examination Table on RTC
→ Pg 47

Features

Foam Details PU Foam with density 40 kg/ cubic metre

Design

- 2 Section Mattress which is water resistant, fire retardant & antimicrobial painted to prevent bacterial growth.
- Easy to remove and clean.

Compatibility Examination Table Ratchet Model

Specification
All sizes in cm

	Length	Depth	Height
Overall dimension	183.3	60.0	3.0

Rapid ERT Mattress



Rapid & Rapid Neo Emergency Recovery Trolley
→ Pg 58

Features

Foam Details PU Foam with density 40kg/ cubic metre

Design

- Single Section Mattress which is water resistant, fire retardant & antimicrobial painted to prevent bacterial growth.
- Easy to remove and clean.

Compatibility Rapid & Rapid NEO Emergency Recovery Trolley

Specification
All sizes in cm

	Length	Depth	Height
Overall dimension	180.3	59.0	5.0

Solace Mattress



Features

Foam Details	PU Foam with density 40kg/cubic metre
Design	<ul style="list-style-type: none"> Two Separate Mattress sections are provided for upper section and lower leg section. Mattress is water resistant, fire retardant & antimicrobial painted to prevent bacterial growth. Easy to remove and clean.
Compatibility	Solace LDRP Range



LDRP Bed Solace →Pg 50



Solace Lite LDRP Bed →Pg 62

Specification
All sizes in cm

	Length	Depth	Height
Overall dimension	189.5	89.0	15.0

Recommended Products

Page 98

**Medical Heads/
Senior Doctor's
Room**

Page 102

Library

Page 102

Meeting Room

Page 99

Training Room

Page 103

**Admin and
Nursing
Station**

Page 100

Lab

Page 101

Record Room

Page 104

Cafeteria

Page 105

OPDS

Page 106

**Waiting
Areas**

Medical Heads / Senior Doctor's Room



Impress



Maestro



Aero



Marvel



Unlearn



Flip NXT



Scintilla with Desklet

Training Room



Enlighten

Lab



Fusion



Nucleus



Aeolus

Record Room



Optimizer Plus



Personal Locker Unit



Gain

Library



Book Rack



Glass Door Storewel



Storewel Plain

Meeting Room



Conclave

Admin and Nursing Station



Wish



VSDU



LFC



Mobile Caddy



VFC

Cafeteria



Cantina



Flip NXT



Time Out



Unwind

OPDS



Enterprise



Work



Motion

Waiting Area



Matrix



Unwind on Beam



Greet

Credentials



India Design Mark



USFDA Certificate



CE Certificate



ISO 13485 Certificate

Healthcare Experience Centre

Visit our Healthcare Experience Centre to experience the latest healthcare products from our range, firsthand – from patient care, to medical screening to office & leisure furniture.

Products Available: ICU Beds, Examination Beds, Gynaec Examination Couch, Recovery Bed, Emergency Trolley, Nursing Station, Office Furniture and more.



Index

Bed

Motorized Range

Page 10 — 30



Chrysalis Nova Activ Bed 10



Chrysalis Nova Plus Bed 12



Chrysalis Nova Bed 14



Chrysalis TWCL Bed 16



Chrysalis SWDL Bed 18



Acura Prime Plus Embedded Panels 5F Motorized Bed with PP Sideboards 20



Acura Prime XP 5F Motorized Bed with PP Sideboards 22



Acura Prime XP 5F Motorized Bed with Aluminium Sideboards 24



Acura Vital 2F Bed with PP Sideboards 26



Grace 2F Homecare Motorized Bed with PP Sideboards 28

Semi Motorized Range

Page 30 — 33



Acura Standard 3F Semi-Motorized Bed with Sideboards 30



Acura Lite 3F Semi-Motorized Bed With MS Side rail 32

Index

Manual ICU Range

Page 34 — 39



Acura Standard 5F Manual Bed with Sideboards 34



Acura Neo 5F Manual Bed with Sideboards 36



Acura Lite 5F Manual Bed with Sideboards 38

Manual Range

Page 40 — 50



Acura Vital 2F Manual Bed with PP Sideboards 40



Ayush Plus Lite Fowler PP Bed 42



Ayush Plus Lite Fowler SSPLT Bed 43



Ayush Lite Fowler MS Bed 44



Ayush Plus Lite Semi Fowler PP Bed 45



Ayush Plus Lite Semi Fowler SSPLT Bed 46



Ayush Lite Semi Fowler MS Bed 47



Ayush Plus Lite Sheet SSPLT Bed 48



Ayush Lite Sheet MS Bed 49



Ayush Lite Attendant Bed 50

Index

Couch

Motorized

Page 52 — 54



Repos Procedure Couch with Accessories 52



Repos Gynaec Couch with Accessories 53



Repos Physical Examination Table with Accessories 54

Couch

Manual

Page 55 — 56



Revive Full Storage Couch 55



Examination Table on RTC 56



Examination Table on RTC — Gynaec 56

Infant Crib & Trolley

Page 58 — 59



Pediatric Bed 58



Crib on Trolley 59



Crib on Bed with PP Sideboard 59

Birthing Bed

Page 60 — 62



Solace LDRP Bed 60



Solace Lite LDRP Bed 62

Index

Locker

Page 66 — 68



Aptis Locker 2 Drawer 1 Cabinet 66



Aptis Locker 1 Drawer 1 Cabinet 67



Aptis Locker 1 Cabinet 67



Delux Locker 1 Drawer 1 Cabinet 68



Simple Locker 1 Cabinet 68

Over Bed Table

Page 69 — 71



Adeo OBTable on Gas Lift Split Type 69



Aptis OBTable on Gas Lift 70



Aptis OBTable on Crank 70



Ayush Fixed Height OBTable 71

Index

Patient Mobility

Page 72 — 77



Stretcher on Trolley 72



Rapid Neo ERT 73



Folding WheelChair Cushion 74



Agilo Medicine Cart 75



Agilo Emergency Cart 76



SS Crash Cart 77

SS Trolleys & Carts

Page 79 — 81



Instrument Trolley Bowl and Bucket / Dressing Trolley 79



Instrument Trolley 79



Medicine Trolley 80



Mayo Trolley 80



Instrument Cabinet 81



Oxygen Cylinder Trolley 81

Index

SS & MS Accessories

Page 82 — 88



Kick Bucket 82



Basin Stand 82



Single Step Stool 83



Double Step Stool 83



Square Stool 84



Round Stool 84



3 fold Screen 85



Soil Linen Trolley 85



Lite IV Pole 86



Infusion Pole 86



MS Saline Stand 86



SS Saline Stand 86



SS and MS Side Rails 87



Traction Pulley 88



Patient Lifting Pole 88

Index

Mattress

Page 90 — 96



Chrysalis Mattress 90



Acura Mattress 91



4 Section Mattress 92



2 Section Mattress 92



Single Section Mattress 93



Attendant Bed Mattress 93



Crib Mattress 94



Pediatric Bed Mattress 94



Examination Table Mattress 95



Rapid ERT Mattress 95



Solace Mattress 96

Index

Recommended Products

Medical Heads/ Senior Doctor's Room

Page 98



Impress 98



Maestro 98



Aetro 98



Marvel 98

Training Room

Page 99



Enlighten 99



Unlearn 99



Flip NXT 99



Scintilla with Desklet 99

Lab

Page 100



Fusion 87



Nucleus 88



Aeolus 88

Index

Record Room

Page 101



Optimizer Plus 101



Personal Locker Unit 101



Gain 101

Library

Page 102



Book Rack 102



Glass Door Storewel 102



Storewel Plain 102

Meeting Room

Page 102



Conclave 102

Admin & Nursing Station

Page 103



Wish 103



VSDU 103



LFC 103



Mobile Caddy 103



VFC 103

Index

Cafeteria

Page 104



Cantina 104



Flip NXT 104



Time Out 104

OPDS

Page 105



Enterprise 105



Work 105



Motion 105

Waiting Area

Page 106



Matrix 106



Unwind on Beam 106



Greet 106



Available in 600 locations in India.

North: Delhi, Chandigarh, NCR, Lucknow

South: Chennai, Bengaluru, Hyderabad, Kochi

West: Mumbai, Ahmedabad, Bhopal, Pune

East: Kolkata, Bhubaneswar, Guwahati, Patna

Godrej & Boyce Mfg. Co. Ltd.

Godrej Interio,
Pirojshanagar, Vikhroli (W),
Mumbai 400 079

Toll Free Number: 1800-209-5511

Email: sales@godrejinterio.com

Website: www.godrejinterio.com

B2BHCDOSSOCT2022

godrejinterio.com/business



TRA Research
India's
Most Desired Brand
2021
Furniture category



TRA Research
India's
Most Trusted Brand
2022
Furniture Category



Franchise India
Retail Brand of the Year
2022
Speciality/Furniture
Retail Category



Marksmen Daily
Most Preferred Brand
2022

Godrej interio
talk green.
walk green.

An initiative by Godrej Interio,
the first Indian furniture company
with GREENGUARD certified products.

MODULAR FURNITURE . DESKING . SEATING . STORAGE . INTERIORS . LAB . HEALTHCARE . HOME

Follow us on /godrejinterio



The GREENGUARD Certification Program gives assurance that products designed for use in indoor spaces meet strict chemical emission limits, which create healthier interiors. The certification qualifies for LEED credits and IGBC credits.

In keeping with the Godrej policy of continuous development and improvement, the design, dimension and specification may be updated without prior notice or obligations. Form, Colour and Finish of product in this document are representative of design intent and may vary from actual. Colour options depicted in this catalogue are as close to what modern printing processes allow. All dimensions are in 'cm' and are subject to commercial tolerance. Our products are meant for indoor use only.