

ORGANIZE SPACE

LET'S REORG

■ MODULAR TROLLEYS **SERIES COMBI**

SEVERAL WHEELS TYPES

STRONG AND RELIABLE THROUGH TIME

VERSATILE

SUITABLE FOR MATERIALS HANDLING AND STORAGE





ORGANIZE SPACE LET'S REORG

COMBI

STANDARD RUBBER WHEELS

**ORD. NO. C RG DAC11 100**

Ø 100 mm

C 130 mm

SWIVEL WHEEL WITH BRAKE

KIND OF TROLLEY	COMBI CE	COMBI CF1	COMBI CF2	COMBI CL1	COMBI CL2	COMBI CI	COMBI CK	COMBI CG	COMBI CH	COMBI CP1	COMBI CR 0091/0071/0031	COMBI CR 0021
LOAD CAPACITY KG	-	175	175	175	175	-	-	-	-	150	150	-

**ORD. NO. C RG CAC11 100**

Ø 100 mm

C 130 mm

SWIVEL WHEEL WITHOUT BRAKE

KIND OF TROLLEY	COMBI CE	COMBI CF1	COMBI CF2	COMBI CL1	COMBI CL2	COMBI CI	COMBI CK	COMBI CG	COMBI CH	COMBI CP1	COMBI CR 0091/0071/0031	COMBI CR 0021
LOAD CAPACITY KG	-	175	175	175	175	-	-	-	-	150	150	-

**ORD. NO. C RG DAC12 125**

Ø 125 mm

C 160 mm

SWIVEL WHEEL WITH BRAKE

KIND OF TROLLEY	COMBI CE	COMBI CF1	COMBI CF2	COMBI CL1	COMBI CL2	COMBI CI	COMBI CK	COMBI CG	COMBI CH	COMBI CP1	COMBI CR 0091/0071/0031	COMBI CR 0021
LOAD CAPACITY KG	-	250	250	250	250	-	-	-	-	150	300	-

**ORD. NO. C RG CAC12 125**

Ø 125 mm

C 160 mm

SWIVEL WHEEL WITHOUT BRAKE

KIND OF TROLLEY	COMBI CE	COMBI CF1	COMBI CF2	COMBI CL1	COMBI CL2	COMBI CI	COMBI CK	COMBI CG	COMBI CH	COMBI CP1	COMBI CR 0091/0071/0031	COMBI CR 0021
LOAD CAPACITY KG	-	250	250	250	250	-	-	-	-	150	300	-

**ORD. NO. C RG DAC13 150**

Ø 150 mm

C 185 mm

SWIVEL WHEEL WITH BRAKE

KIND OF TROLLEY	COMBI CE	COMBI CF1	COMBI CF2	COMBI CL1	COMBI CL2	COMBI CI	COMBI CK	COMBI CG	COMBI CH	COMBI CP1	COMBI CR 0091/0071/0031	COMBI CR 0021
LOAD CAPACITY KG	-	250	250	250	250	-	-	-	-	150	300	-

**ORD. NO. C RG CAC13 150**

Ø 150 mm

C 185 mm

SWIVEL WHEEL WITHOUT BRAKE

KIND OF TROLLEY	COMBI CE	COMBI CF1	COMBI CF2	COMBI CL1	COMBI CL2	COMBI CI	COMBI CK	COMBI CG	COMBI CH	COMBI CP1	COMBI CR 0091/0071/0031	COMBI CR 0021
LOAD CAPACITY KG	-	250	250	250	250	-	-	-	-	150	300	-

**ORD. NO. C RG DAC15 200**

Ø 200 mm

C 242 mm

SWIVEL WHEEL WITH BRAKE

KIND OF TROLLEY	COMBI CE	COMBI CF1	COMBI CF2	COMBI CL1	COMBI CL2	COMBI CI	COMBI CK	COMBI CG	COMBI CH	COMBI CP1	COMBI CR 0091/0071/0031	COMBI CR 0021
LOAD CAPACITY KG	500	-	-	-	-	500	500	500	500	-	-	-

**ORD. NO. C RG CAC15 200**

Ø 200 mm

C 242 mm

SWIVEL WHEEL WITHOUT BRAKE

KIND OF TROLLEY	COMBI CE	COMBI CF1	COMBI CF2	COMBI CL1	COMBI CL2	COMBI CI	COMBI CK	COMBI CG	COMBI CH	COMBI CP1	COMBI CR 0091/0071/0031	COMBI CR 0021
LOAD CAPACITY KG	500	-	-	-	-	500	500	500	500	-	-	-

**ORD. NO. C RG FAC11 100**

Ø 100 mm

C 120 mm

SWIVEL WHEEL WITHOUT BRAKE

KIND OF TROLLEY	COMBI CE	COMBI CF1	COMBI CF2	COMBI CL1	COMBI CL2	COMBI CI	COMBI CK	COMBI CG	COMBI CH	COMBI CP1	COMBI CR 0091/0071/0031	COMBI CR 0021
LOAD CAPACITY KG	-	-	-	-	-	-	-	-	-	-	-	150

With screw M12x35

STANDARD RUBBER WHEELS

**ORD. NO. C RG BAC11 100**

Ø 100 mm

C 130 mm

FIXED WHEEL

KIND OF TROLLEY	COMBI CE	COMBI CF1	COMBI CF2	COMBI CL1	COMBI CL2	COMBI CI	COMBI CK	COMBI CG	COMBI CH	COMBI CP1	COMBI CR 0091/0071/0031	COMBI CR 0021
LOAD CAPACITY KG	-	175	175	175	175	-	-	-	-	150	150	-

**ORD. NO. C RG BAC12 125**

Ø 125 mm

C 160 mm

FIXED WHEEL

KIND OF TROLLEY	COMBI CE	COMBI CF1	COMBI CF2	COMBI CL1	COMBI CL2	COMBI CI	COMBI CK	COMBI CG	COMBI CH	COMBI CP1	COMBI CR 0091/0071/0031	COMBI CR 0021
LOAD CAPACITY KG	-	250	250	250	250	-	-	-	-	150	300	-

**ORD. NO. C RG BAC13 150**

Ø 150 mm

C 185 mm

FIXED WHEEL

KIND OF TROLLEY	COMBI CE	COMBI CF1	COMBI CF2	COMBI CL1	COMBI CL2	COMBI CI	COMBI CK	COMBI CG	COMBI CH	COMBI CP1	COMBI CR 0091/0071/0031	COMBI CR 0021
LOAD CAPACITY KG	-	250	250	250	250	-	-	-	-	150	300	-

**ORD. NO. C RG BAC15 200**

Ø 200 mm

C 242 mm

FIXED WHEEL

KIND OF TROLLEY	COMBI CE	COMBI CF1	COMBI CF2	COMBI CL1	COMBI CL2	COMBI CI	COMBI CK	COMBI CG	COMBI CH	COMBI CP1	COMBI CR 0091/0071/0031	COMBI CR 0021
LOAD CAPACITY KG	500	-	-	-	-	500	500	500	500	-	-	-

NO-SMEAR RUBBER WHEELS

**ORD. NO. C RG DPH22 125**

Ø 125 mm

C 160 mm

SWIVEL WHEEL WITH BRAKE

KIND OF TROLLEY	COMBI CE	COMBI CF1	COMBI CF2	COMBI CL1	COMBI CL2	COMBI CI	COMBI CK	COMBI CG	COMBI CH	COMBI CP1	COMBI CR 0091/0071/0031	COMBI CR 0021
LOAD CAPACITY KG	-	250	250	250	250	-	-	-	-	150	300	-

**ORD. NO. C RG DPH25 160**

Ø 160 mm

C 204 mm

SWIVEL WHEEL WITH BRAKE

KIND OF TROLLEY	COMBI CE	COMBI CF1	COMBI CF2	COMBI CL1	COMBI CL2	COMBI CI	COMBI CK	COMBI CG	COMBI CH	COMBI CP1	COMBI CR 0091/0071/0031	COMBI CR 0021
LOAD CAPACITY KG	500	-	-	-	-	500	500	500	500	-	-	-

**ORD. NO. C RG BPH22 125**

Ø 125 mm

C 160 mm

FIXED WHEEL

KIND OF TROLLEY	COMBI CE	COMBI CF1	COMBI CF2	COMBI CL1	COMBI CL2	COMBI CI	COMBI CK	COMBI CG	COMBI CH	COMBI CP1	COMBI CR 0091/0071/0031	COMBI CR 0021
LOAD CAPACITY KG	-	250	250	250	250	-	-	-	-	150	300	-

**ORD. NO. C RG BPH25 160**

Ø 160 mm

C 204 mm

FIXED WHEEL

KIND OF TROLLEY	COMBI CE	COMBI CF1	COMBI CF2	COMBI CL1	COMBI CL2	COMBI CI	COMBI CK	COMBI CG	COMBI CH	COMBI CP1	COMBI CR 0091/0071/0031	COMBI CR 0021
LOAD CAPACITY KG	500	-	-	-	-	500	500	500	500	-	-	-

COMBI

ELASTIC RUBBER WHEELS

ORD. NO. C RG DCE15 125 \varnothing 125 mm C 160 mm **SWIVEL WHEEL WITH BRAKE**

KIND OF TROLLEY	COMBI CE	COMBI CF1	COMBI CF2	COMBI CL1	COMBI CL2	COMBI CI	COMBI CK	COMBI CG	COMBI CH	COMBI CP1	COMBI CR 0091/0071/0031	COMBI CR 0021
LOAD CAPACITY KG	-	250	250	250	250	-	-	-	-	150	300	-

ORD. NO. C RG DCE15 160 \varnothing 160 mm C 204 mm **SWIVEL WHEEL WITH BRAKE**

KIND OF TROLLEY	COMBI CE	COMBI CF1	COMBI CF2	COMBI CL1	COMBI CL2	COMBI CI	COMBI CK	COMBI CG	COMBI CH	COMBI CP1	COMBI CR 0091/0071/0031	COMBI CR 0021
LOAD CAPACITY KG	500	-	-	-	-	500	500	500	500	-	-	-

ORD. NO. C RG BCE15 125 \varnothing 125 mm C 160 mm **FIXED WHEEL**

KIND OF TROLLEY	COMBI CE	COMBI CF1	COMBI CF2	COMBI CL1	COMBI CL2	COMBI CI	COMBI CK	COMBI CG	COMBI CH	COMBI CP1	COMBI CR 0091/0071/0031	COMBI CR 0021
LOAD CAPACITY KG	-	250	250	250	250	-	-	-	-	150	300	-

ORD. NO. C RG BCE15 160 \varnothing 160 mm C 204 mm **FIXED WHEEL**

KIND OF TROLLEY	COMBI CE	COMBI CF1	COMBI CF2	COMBI CL1	COMBI CL2	COMBI CI	COMBI CK	COMBI CG	COMBI CH	COMBI CP1	COMBI CR 0091/0071/0031	COMBI CR 0021
LOAD CAPACITY KG	500	-	-	-	-	500	500	500	500	-	-	-

INFLATABLE WHEELS

ORD. NO. C RG CMH11 200 \varnothing 200 mm C 238 mm **SWIVEL WHEEL WITHOUT BRAKE**

KIND OF TROLLEY	COMBI CE	COMBI CF1	COMBI CF2	COMBI CL1	COMBI CL2	COMBI CI	COMBI CK	COMBI CG	COMBI CH	COMBI CP1	COMBI CR 0091/0071/0031	COMBI CR 0021
LOAD CAPACITY KG	170	-	-	-	-	170	170	170	170	-	-	-

ORD. NO. C RG BMH11 200 \varnothing 200 mm C 238 mm **FIXED WHEEL**

KIND OF TROLLEY	COMBI CE	COMBI CF1	COMBI CF2	COMBI CL1	COMBI CL2	COMBI CI	COMBI CK	COMBI CG	COMBI CH	COMBI CP1	COMBI CR 0091/0071/0031	COMBI CR 0021
LOAD CAPACITY KG	170	-	-	-	-	170	170	170	170	-	-	-

RAL 7000 F.01

RAL 6011 F.02

RAL 5012 F.04

RAL 7035 F.08

INFO ■

www.famispa.com



ORD. NO. C RN DAD10 100 \varnothing 100 mm C 130 mm **SWIVEL WHEEL WITH BRAKE**

KIND OF TROLLEY	COMBI CE	COMBI CF1	COMBI CF2	COMBI CL1	COMBI CL2	COMBI CI	COMBI CK	COMBI CG	COMBI CH	COMBI CP1	COMBI CR 0091/0071/0031	COMBI CR 0021
LOAD CAPACITY KG	-	250	250	250	250	-	-	-	-	150	300	-

ORD. NO. C RN DAD11 125 \varnothing 125 mm C 160 mm **SWIVEL WHEEL WITH BRAKE**

KIND OF TROLLEY	COMBI CE	COMBI CF1	COMBI CF2	COMBI CL1	COMBI CL2	COMBI CI	COMBI CK	COMBI CG	COMBI CH	COMBI CP1	COMBI CR 0091/0071/0031	COMBI CR 0021
LOAD CAPACITY KG	-	250	250	250	250	-	-	-	-	150	300	-

ORD. NO. C RN DAD04 160 \varnothing 160 mm C 204 mm **SWIVEL WHEEL WITH BRAKE**

KIND OF TROLLEY	COMBI CE	COMBI CF1	COMBI CF2	COMBI CL1	COMBI CL2	COMBI CI	COMBI CK	COMBI CG	COMBI CH	COMBI CP1	COMBI CR 0091/0071/0031	COMBI CR 0021
LOAD CAPACITY KG	500	-	-	-	-	500	500	500	500	-	-	-

ORD. NO. C RN BAD10 100 \varnothing 100 mm C 130 mm **FIXED WHEEL**

KIND OF TROLLEY	COMBI CE	COMBI CF1	COMBI CF2	COMBI CL1	COMBI CL2	COMBI CI	COMBI CK	COMBI CG	COMBI CH	COMBI CP1	COMBI CR 0091/0071/0031	COMBI CR 0021
LOAD CAPACITY KG	-	250	250	250	250	-	-	-	-	150	300	-

ORD. NO. C RN BAD11 125 \varnothing 125 mm C 160 mm **FIXED WHEEL**

KIND OF TROLLEY	COMBI CE	COMBI CF1	COMBI CF2	COMBI CL1	COMBI CL2	COMBI CI	COMBI CK	COMBI CG	COMBI CH	COMBI CP1	COMBI CR 0091/0071/0031	COMBI CR 0021
LOAD CAPACITY KG	-	250	250	250	250	-	-	-	-	150	300	-

ORD. NO. C RN BAD04 160 \varnothing 160 mm C 204 mm **FIXED WHEEL**

KIND OF TROLLEY	COMBI CE	COMBI CF1	COMBI CF2	COMBI CL1	COMBI CL2	COMBI CI	COMBI CK	COMBI CG	COMBI CH	COMBI CP1	COMBI CR 0091/0071/0031	COMBI CR 0021
LOAD CAPACITY KG	500	-	-	-	-	500	500	500	500	-	-	-



COMBI

POLYURETHANE WHEELS

ORD. NO. C RN DDD31 125 \varnothing 125 mm C 160 mm **SWIVEL WHEEL WITH BRAKE**

KIND OF TROLLEY	COMBI CE	COMBI CF1	COMBI CF2	COMBI CL1	COMBI CL2	COMBI CI	COMBI CK	COMBI CG	COMBI CH	COMBI CP1	COMBI CR 0091/0071/0031	COMBI CR 0021
LOAD CAPACITY KG	-	250	250	250	250	-	-	-	-	150	300	-

ORD. NO. C RN DDD44 160 \varnothing 160 mm C 204 mm **SWIVEL WHEEL WITH BRAKE**

KIND OF TROLLEY	COMBI CE	COMBI CF1	COMBI CF2	COMBI CL1	COMBI CL2	COMBI CI	COMBI CK	COMBI CG	COMBI CH	COMBI CP1	COMBI CR 0091/0071/0031	COMBI CR 0021
LOAD CAPACITY KG	500	-	-	-	-	500	500	500	500	-	-	-

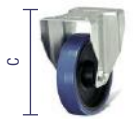
ORD. NO. C RN BDD31 125 \varnothing 125 mm C 160 mm **FIXED WHEEL**

KIND OF TROLLEY	COMBI CE	COMBI CF1	COMBI CF2	COMBI CL1	COMBI CL2	COMBI CI	COMBI CK	COMBI CG	COMBI CH	COMBI CP1	COMBI CR 0091/0071/0031	COMBI CR 0021
LOAD CAPACITY KG	-	250	250	250	250	-	-	-	-	150	300	-

ORD. NO. C RN BDD44 160 \varnothing 160 mm C 204 mm **FIXED WHEEL**

KIND OF TROLLEY	COMBI CE	COMBI CF1	COMBI CF2	COMBI CL1	COMBI CL2	COMBI CI	COMBI CK	COMBI CG	COMBI CH	COMBI CP1	COMBI CR 0091/0071/0031	COMBI CR 0021
LOAD CAPACITY KG	500	-	-	-	-	500	500	500	500	-	-	-



CONDUCTIVE WHEELS



ORD. NO. C RG DDD11 100 \varnothing 100 mm C 130 mm **SWIVEL WHEEL WITH BRAKE**

KIND OF TROLLEY	COMBI CE	COMBI CF1	COMBI CF2	COMBI CL1	COMBI CL2	COMBI CI	COMBI CK	COMBI CG	COMBI CH	COMBI CP1	COMBI CR 0091/0071/0031	COMBI CR 0021
LOAD CAPACITY KG	-	160	160	160	160	-	-	-	-	150	160	-



ORD. NO. C RG CDD111 100 \varnothing 100 mm C 130 mm **SWIVEL WHEEL WITHOUT BRAKE**

KIND OF TROLLEY	COMBI CE	COMBI CF1	COMBI CF2	COMBI CL1	COMBI CL2	COMBI CI	COMBI CK	COMBI CG	COMBI CH	COMBI CP1	COMBI CR 0091/0071/0031	COMBI CR 0021
LOAD CAPACITY KG	-	160	160	160	160	-	-	-	-	150	160	-



ORD. NO. C RG CDD13 150 \varnothing 150 mm C 185 mm **SWIVEL WHEEL WITHOUT BRAKE**

KIND OF TROLLEY	COMBI CE	COMBI CF1	COMBI CF2	COMBI CL1	COMBI CL2	COMBI CI	COMBI CK	COMBI CG	COMBI CH	COMBI CP1	COMBI CR 0091/0071/0031	COMBI CR 0021
LOAD CAPACITY KG	-	250	250	250	250	-	-	-	-	150	300	-



With screw M12x35

ORD. NO. C RG RDD11 100 \varnothing 100 mm C 120 mm **SWIVEL WHEEL WITH BRAKE**

KIND OF TROLLEY	COMBI CE	COMBI CF1	COMBI CF2	COMBI CL1	COMBI CL2	COMBI CI	COMBI CK	COMBI CG	COMBI CH	COMBI CP1	COMBI CR 0091/0071/0031	COMBI CR 0021
LOAD CAPACITY KG	-	-	-	-	-	-	-	-	-	-	-	150

ORD. NO. C RG FDD11 100 \varnothing 100 mm C 120 mm **SWIVEL WHEEL WITHOUT BRAKE**

KIND OF TROLLEY	COMBI CE	COMBI CF1	COMBI CF2	COMBI CL1	COMBI CL2	COMBI CI	COMBI CK	COMBI CG	COMBI CH	COMBI CP1	COMBI CR 0091/0071/0031	COMBI CR 0021
LOAD CAPACITY KG	-	-	-	-	-	-	-	-	-	-	-	150



ORD. NO. C RG BDD11 100 \varnothing 100 mm C 130 mm **FIXED WHEEL**

KIND OF TROLLEY	COMBI CE	COMBI CF1	COMBI CF2	COMBI CL1	COMBI CL2	COMBI CI	COMBI CK	COMBI CG	COMBI CH	COMBI CP1	COMBI CR 0091/0071/0031	COMBI CR 0021
LOAD CAPACITY KG	-	175	175	175	175	-	-	-	-	150	150	-



ORD. NO. C RG BDD13 150 \varnothing 150 mm C 185 mm **FIXED WHEEL**

KIND OF TROLLEY	COMBI CE	COMBI CF1	COMBI CF2	COMBI CL1	COMBI CL2	COMBI CI	COMBI CK	COMBI CG	COMBI CH	COMBI CP1	COMBI CR 0091/0071/0031	COMBI CR 0021
LOAD CAPACITY KG	-	250	250	250	250	-	-	-	-	150	300	-

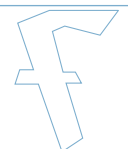

TROLLEYS SERIES COMBI CE

**DIN A4 DOCUMENT HOLDER**

ORD. NO.	DESCRIPTION
F CE 0980 00 99	DIN A4 horizontal wooden document holder
F CE 0985 00 99	DIN A4 vertical wooden document holder

SMOOTH RUBBER

ORD. NO.	DIM. mm	For mm wide trolleys
F CE 0595 00 07	1065x700	700
F CE 0600 00 07	1345x825	825

**STEEL RETAINERS**

ORD. NO.	DIM. mm	For mm wide trolleys
F CE 0925 00 04	663x38x100 h	700
F CE 0930 00 04	788x38x100 h	825



RAL 5012 F.04 RAL 6011 F.02

**KEY ■**

- The trolleys series COMBI CE are as standard supplied unassembled



WIDTH = 1135/1420 mm DEPTH = 700/825 mm HEIGHT (H) = 1000 mm

TROLLEYS SERIES COMBI CE



■ 04
■ 02

ORD. NO.

F CE B105 03 04

Trolley with 2 standard rubber swivel wheels **with** brakes and 2 standard rubber fixed wheels \varnothing 125 mm
Load capacity: 250 kg **Dim. mm 1135x700x915 h**



■ 04
■ 02



■ 04
■ 02

ORD. NO.

F CE P105 24 04

Trolley with 2 standard rubber swivel wheels **with** brakes and 2 standard rubber fixed wheels \varnothing 200 mm
Load capacity: 500 kg **Dim. mm 1095x715x1135 h**

ORD. NO.

F CE P105 23 04

Trolley with 2 standard rubber swivel wheels **with** brakes and 2 standard rubber fixed wheels \varnothing 200 mm
Load capacity: 500 kg **Dim. mm 1063x700x1080 h**



■ 04
■ 02



■ 04
■ 02

ORD. NO.

F CE P106 03 04

Trolley with 2 standard rubber swivel wheels **with** brakes and 2 standard rubber fixed wheels \varnothing 200 mm
Load capacity: 500 kg **Dim. mm 1135x700x1000 h**

ORD. NO.

F CE P105 03 04

Trolley with 2 standard rubber swivel wheels **with** brakes and 2 standard rubber fixed wheels \varnothing 200 mm
Load capacity: 500 kg **Dim. mm 1135x700x1000 h**

ORD. NO.

F CE P256 03 04

Trolley with 2 standard rubber swivel wheels **with** brakes and 2 standard rubber fixed wheels \varnothing 200 mm
Load capacity: 500 kg **Dim. mm 1420x825x1000 h**

ORD. NO.

F CE P255 03 04

Trolley with 2 standard rubber swivel wheels **with** brakes and 2 standard rubber fixed wheels \varnothing 200 mm
Load capacity: 500 kg **Dim. mm 1420x825x1000 h**

■ KEY

RAL 5012 F. 04

RAL 6011 F. 02



■ All indicated loads are net and refer to evenly distributed weights



TROLLEYS SERIES COMBI CE

TROLLEYS WITH 2 STANDARD RUBBER SWIVEL WHEELS WITH BRAKES AND 2 STANDARD RUBBER FIXED WHEELS Ø 200 mm



■ 04
■ 02

ORD. NO.	DIM. mm
F CE P105 04 04	1135x700x1000 h
F CE P255 04 04	1420x825x1000 h
Load capacity: 500 kg	



■ 04
■ 02

ORD. NO.	DIM. mm
F CE P105 12 04	1200x700x1000 h
F CE P255 12 04	1485x825x1000 h
Load capacity: 500 kg	



■ 04
■ 02

ORD. NO.	DIM. mm
F CE P105 06 04	1200x700x1000 h
F CE P255 06 04	1485x825x1000 h
Load capacity: 500 kg	



■ 04
■ 02

ORD. NO.	DIM. mm
F CE P105 22 04	1063x700x1080 h



■ 04
■ 02

ORD. NO.	DIM. mm
F CE P105 07 04	1200x700x1000 h
F CE P255 07 04	1485x825x1000 h
Load capacity: 500 kg	

TROLLEYS WITH 2 STANDARD RUBBER SWIVEL WHEELS WITH BRAKES AND 2 STANDARD RUBBER FIXED WHEELS Ø 200 mm



■ 04
■ 02

ORD. NO.	DIM. mm
F CE P105 08 04	1135x700x1000 h
F CE P255 08 04	1420x825x1000 h
Load capacity: 500 kg	



■ 04
■ 02

ORD. NO.	DIM. mm
F CE P105 15 04	1200x700x1000 h
F CE P255 15 04	1485x825x1000 h
Load capacity: 500 kg	



■ 04
■ 02

ORD. NO.	DIM. mm
F CE P105 10 04	1200x700x1000 h
F CE P255 10 04	1485x825x1000 h
Load capacity: 500 kg	



■ 04
■ 02

ORD. NO.	DIM. mm
F CE P106 10 04	1200x700x1000 h



■ 04
■ 02

ORD. NO.	DIM. mm
F CE P105 11 04	1200x700x1000 h
F CE P255 11 04	1485x825x1000 h
Load capacity: 500 kg	

WIDTH = 1135/1420 mm DEPTH = 700/825 mm HEIGHT (H) = 1000 mm

TROLLEYS SERIES COMBI CE

TROLLEYS WITH 2 STANDARD RUBBER SWIVEL WHEELS WITH BRAKES AND 2 STANDARD RUBBER FIXED WHEELS Ø 200 mm



04
02

ORD. NO.	DIM. mm
F CE P105 20 04	1095x700x1000 h
F CE P255 20 04	1380x825x1000 h

Load capacity: 500 kg



04
02

ORD. NO.	DIM. mm
F CE P106 20 04	1095x700x1000 h
F CE P256 20 04	1380x825x1000 h

Load capacity: 500 kg



04
02

ORD. NO.	DIM. mm
F CE P105 21 04	1095x700x1000 h

Load capacity: 500 kg



04
02

ORD. NO.	DIM. mm
F CE P106 21 04	1095x700x1000 h

Load capacity: 500 kg

TROLLEYS WITH 2 STANDARD RUBBER SWIVEL WHEELS WITH BRAKES AND 2 STANDARD RUBBER FIXED WHEELS Ø 200 mm

ORD. NO.	DIMENSIONS mm
F CE P106 18 04	1135x700x1000 h



ORD. NO.	DIMENSIONS mm
F CE P105 08 04	1135x700x1000 h

04
02



KEY



All indicated loads are net and refer to evenly distributed weights

RAL 5012 F.04 RAL 6011 F.02



TROLLEYS SERIES COMBI CE

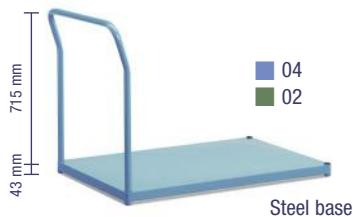

ORD. NO.	DIM. mm
F CE 0105 03 04	1135x700x758 h
Trolley suitable for wheels Ø 160–200 mm	

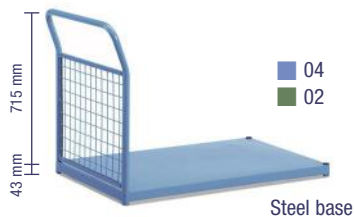

ORD. NO.	DIM. mm
F CE 0105 04 04	1135x700x758 h
F CE 0255 04 04	1420x825x758 h
Trolley suitable for wheels Ø 160–200 mm	



ORD. NO.	DIM. mm
F CE 0105 12 04	1200x700x758 h
F CE 0255 12 04	1485x825x758 h
Trolley suitable for wheels Ø 160–200 mm	

ORD. NO.	DIM. mm
F CE 0105 06 04	1200x700x758 h
F CE 0255 06 04	1485x825x758 h
Trolley suitable for wheels Ø 160–200 mm	



ORD. NO.	DIM. mm
F CE 0105 21 04	1095x700x758 h
Trolley suitable for wheels Ø 160–200 mm	



ORD. NO.	DIM. mm
F CE 0106 21 04	1095x700x758 h
Trolley suitable for wheels Ø 160–200 mm	



ORD. NO.	DIM. mm
F CE 0105 23 04	1063x700x838 h
Trolley suitable for wheels Ø 160–200 mm	

ORD. NO.	DIM. mm
F CE 0105 24 04	1095x715x893 h
Trolley suitable for wheels Ø 160–200 mm	



RAL 5012 F.04 RAL 6011 F.02

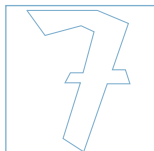

■ Wheels see page E2-E7

KEY ■

■ All indicated loads are net and refer to evenly distributed weights



WIDTH = 1135/1420 mm DEPTH = 700/825 mm HEIGHT (H) = 1000 mm

TROLLEYS SERIES COMBI CE



Steel base



Wooden base



Steel base

ORD. NO.	DIM. mm
F CE 0105 20 04	1095x700x758 h
F CE 0255 20 04	1380x825x758 h

Trolley suitable for wheels \varnothing 160–200 mm

ORD. NO.	DIM. mm
F CE 0106 20 04	1095x700x758 h
F CE 0256 20 04	1380x825x758 h

Trolley suitable for wheels \varnothing 160–200 mm

ORD. NO.	DIM. mm
F CE 0105 11 04	1200x700x758 h
F CE 0255 11 04	1485x825x758 h

Trolley suitable for wheels \varnothing 160–200 mm

ORD. NO.	DIM. mm
F CE 0105 07 04	1200x700x758 h
F CE 0255 07 04	1485x825x758 h

Trolley suitable for wheels \varnothing 160–200 mm



Steel base



Wooden base



Steel base



Steel base

ORD. NO.	DIM. mm
F CE 0106 03 04	1135x700x758 h
F CE 0256 03 04	1420x825x758 h

Trolley suitable for wheels \varnothing 160–200 mm

ORD. NO.	DIM. mm
F CE 0105 08 04	1135x700x758 h
F CE 0255 08 04	1420x825x758 h

Trolley suitable for wheels \varnothing 160–200 mm

ORD. NO.	DIM. mm
F CE 0105 15 04	1200x700x758 h
F CE 0255 15 04	1485x825x758 h

Trolley suitable for wheels \varnothing 160–200 mm

ORD. NO.	DIM. mm
F CE 0105 10 04	1200x700x758 h
F CE 0255 10 04	1485x825x758 h

Trolley suitable for wheels \varnothing 160–200 mm



Steel base

KEY



All indicated loads are net and refer to evenly distributed weights

Wheels see page E2-E7

RAL 5012 F.04

RAL 6011 F.02

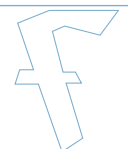

TROLLEYS SERIES COMBI CF1



RAL 5012 F.04 RAL 6011 F.02

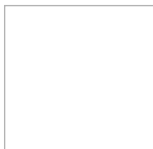
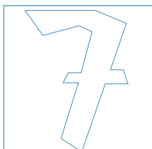

INFO ■

www.famispa.com

WIDTH = 945 mm DEPTH = 525 mm HEIGHT (H) = 1045 mm

TROLLEYS SERIES COMBI CF1



■ 04
■ 02

ORD. NO.

F CF H005 03 04

Trolley with 2 standard rubber swivel wheels **with** brakes and 2 standard rubber fixed wheels **Ø 150 mm**
Load capacity: 250 kg
Dimensions mm 945x525x1045 h



■ 04
■ 02

ORD. NO.

F CF H005 08 04

Trolley with 2 standard rubber swivel wheels **with** brakes and 2 standard rubber fixed wheels **Ø 150 mm**
Load capacity: 250 kg
Dimensions mm 945x525x1045 h



■ 04
■ 02

ORD. NO.

F CF H005 07 04

Trolley with 2 standard rubber swivel wheels **with** brakes and 2 standard rubber fixed wheels **Ø 150 mm**
Load capacity: 250 kg
Dimensions mm 945x525x1045 h



■ 04
■ 02

ORD. NO.

F CF H006 03 04

Trolley with 2 standard rubber swivel wheels **with** brakes and 2 standard rubber fixed wheels **Ø 150 mm**
Load capacity: 250 kg
Dimensions mm 945x525x1045 h



■ 04
■ 02

ORD. NO.

F CF H006 08 04

Trolley with 2 standard rubber swivel wheels **with** brakes and 2 standard rubber fixed wheels **Ø 150 mm**
Load capacity: 250 kg
Dimensions mm 945x525x1045 h



■ 04
■ 02

ORD. NO.

F CF H006 12 04

Trolley with 2 standard rubber swivel wheels **with** brakes and 2 standard rubber fixed wheels **Ø 150 mm**
Load capacity: 250 kg
Dimensions mm 945x525x1045 h



■ 04
■ 02

ORD. NO.

F CF H006 04 04

Trolley with 2 standard rubber swivel wheels **with** brakes and 2 standard rubber fixed wheels **Ø 150 mm**
Load capacity: 250 kg
Dimensions mm 945x525x1045 h



■ 04
■ 02

ORD. NO.

F CF H006 06 04

Trolley with 2 standard rubber swivel wheels **with** brakes and 2 standard rubber fixed wheels **Ø 150 mm**
Load capacity: 250 kg
Dimensions mm 945x525x1045 h

■ KEY



- Load capacity for shelves: 100 kg
- All indicated loads are net and refer to evenly distributed weights

RAL 5012 F. 04 RAL 6011 F. 02



TROLLEYS SERIES COMBI CF1

SIDE FRAMES WITH AND WITHOUT HANDLE, BASES WITH WOODEN PLATE, BASES WITH STEEL PLATE

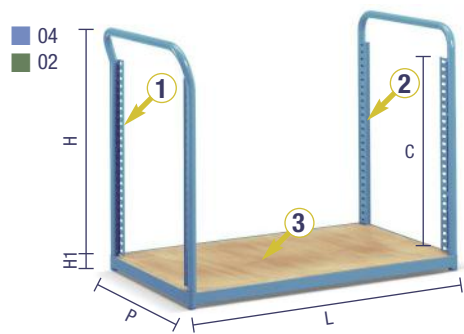

■ L	= 945 mm
■ P	= 525 mm
■ H	= 817 mm
■ H1	= 43 mm
■ C	= 685 mm

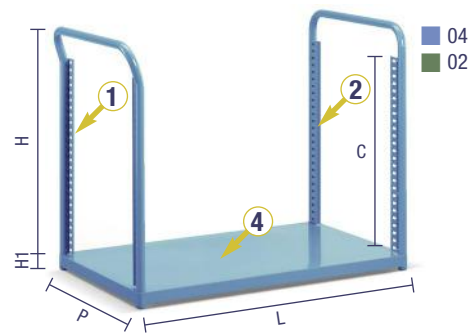

REFERENCE	ORD. NO. SIDE FRAME WITH HANDLE	DIM. mm
①	F CF 0605 00 04	521x70x870 h

REFERENCE	ORD. NO. BASE WITH WOODEN PLATE	DIM. mm
③	F CE G006 00 04	865x525x56 h

REFERENCE	ORD. NO. SIDE FRAME	DIM. mm
②	F CF 0615 00 04	521x30x875 h

REFERENCE	ORD. NO. BASE WITH STEEL PLATE	DIM. mm
④	F CE G005 00 04	865x525x56 h

ADDITIONAL STEEL SHELVES

ORD. NO.	LOAD CAPACITY kg	FOR TROLLEYS DIM. mm
F CF 0510 00 04	100	945x525

Dimensions mm 799x510x30 h



ORD. NO.

F CF 0590 00 07

Smooth rubber for trolleys. Dimensions mm 945x525

CONTAINER RETAINERS

ORD. NO.	SUITABLE FOR	FOR TROLLEYS DIM. mm
F CF 0900 00 99	Steel shelf	945x525
F CF 0901 00 99	Wooden shelf	945x525
F CF 0902 00 99	Steel and wooden bases	945x525

Dimensions mm 795x60

Order no. FCF 0902 00 99 can only be ordered with the base.



ADDITIONAL WOODEN SHELVES

ORD. NO.	LOAD CAPACITY kg	FOR TROLLEYS DIM. mm
F CF 0560 00 04	100	945x525

Dimensions mm 795x500x20 h



ADDITIONAL WOODEN TRAYS

ORD. NO.	LOAD CAPACITY kg	FOR TROLLEYS DIM. mm
F CF 0800 00 04	100	945x525

Dimensions mm 795x510x65 h. Internal dimensions mm 755x470x45 h



RAL 5012 F.04

RAL 6011 F.02

KEY ■

■ Wheels see page E2-E7

■ All indicated loads are net and refer to evenly distributed weights



WIDTH = 945 mm DEPTH = 525 mm HEIGHT (H) = 1045 mm

TROLLEYS SERIES COMBI CF1

MESHES FOR FRONTS

ORD. NO.	FOR TROLLEYS DIM. mm	MESH HOLE mm
F CF 0625 00 04	945x525	50x100
Dimensions mm 384x680		

Single item delivered with 4 clamps



■ 04
■ 02

MESHES FOR SIDES

ORD. NO.	FOR TROLLEYS DIM. mm	MESH HOLE mm
F CF 0700 00 04	945x525	50x100
Dimensions mm 800x680		

Single item delivered with 4 clamps and bolts

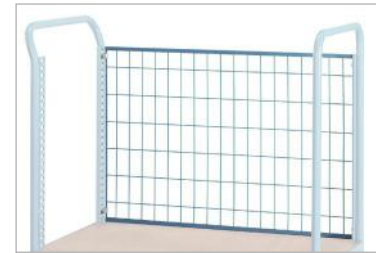

■ 04
■ 02



■ INFO

RAL 5012 F.04 RAL 6011 F.02



www.famispa.com



TROLLEYS SERIES COMBI CF2



RAL 5012 F.04

RAL 6011 F.02

INFO ■

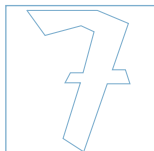

www.famispa.com



WIDTH = 1135 mm DEPTH = 625 mm HEIGHT (H) = 1045 mm

TROLLEYS SERIES COMBI CF2



■ 04
■ 02

ORD. NO.

F CF H055 03 04

Trolley with 2 standard rubber swivel wheels **with** brakes and 2 standard rubber fixed wheels **Ø 150 mm**
Load capacity: 250 kg
Dimensions mm 1135x625x1045 h



■ 04
■ 02

ORD. NO.

F CF H055 08 04

Trolley with 2 standard rubber swivel wheels **with** brakes and 2 standard rubber fixed wheels **Ø 150 mm**
Load capacity: 250 kg
Dimensions mm 1135x625x1045 h



■ 04
■ 02

ORD. NO.

F CF H055 07 04

Trolley with 2 standard rubber swivel wheels **with** brakes and 2 standard rubber fixed wheels **Ø 150 mm**
Load capacity: 250 kg
Dimensions mm 1135x625x1045 h



■ 04
■ 02

ORD. NO.

F CF H056 03 04

Trolley with 2 standard rubber swivel wheels **with** brakes and 2 standard rubber fixed wheels **Ø 150 mm**
Load capacity: 250 kg
Dimensions mm 1135x625x1045 h



■ 04
■ 02

ORD. NO.

F CF H056 08 04

Trolley with 2 standard rubber swivel wheels **with** brakes and 2 standard rubber fixed wheels **Ø 150 mm**
Load capacity: 250 kg
Dimensions mm 1135x625x1045 h



■ 04
■ 02

ORD. NO.

F CF H056 12 04

Trolley with 2 standard rubber swivel wheels **with** brakes and 2 standard rubber fixed wheels **Ø 150 mm**
Load capacity: 250 kg
Dimensions mm 1135x625x1045 h



■ 04
■ 02

ORD. NO.

F CF H056 04 04

Trolley with 2 standard rubber swivel wheels **with** brakes and 2 standard rubber fixed wheels **Ø 150 mm**
Load capacity: 250 kg
Dimensions mm 1135x625x1045 h



■ 04
■ 02

ORD. NO.

F CF H056 06 04

Trolley with 2 standard rubber swivel wheels **with** brakes and 2 standard rubber fixed wheels **Ø 150 mm**
Load capacity: 250 kg
Dimensions mm 1135x625x1045 h

■ KEY

RAL 5012 F. 04 RAL 6011 F. 02



- Shelves load capacity: 100 kg
- All indicated loads are net and refer to evenly distributed weights



TROLLEYS SERIES COMBI CF2

SIDE FRAMES WITH AND WITHOUT HANDLE, BASES WITH WOODEN PLATE, BASES WITH STEEL PLATE

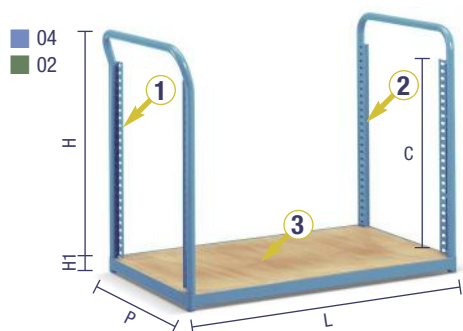

- L = 1135 mm
- P = 625 mm
- H = 817 mm
- H1 = 43 mm
- C = 685 mm

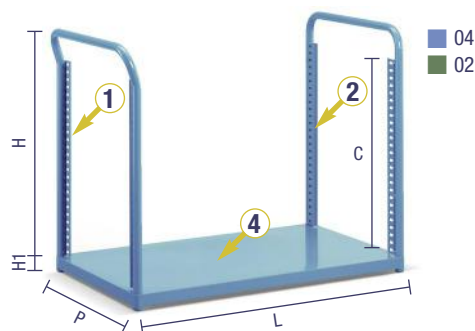

REFERENCE	ORD. NO. SIDE FRAME WITH HANDLE	DIM. mm
1	F CF 0610 00 04	621x70x870 h
REFERENCE	ORD. NO. BASE WITH WOODEN PLATE	DIM. mm
3	F CE G056 00 04	1065x625x56 h

REFERENCE	ORD. NO. SIDE FRAME	DIM. mm
2	F CF 0620 00 04	621x30x875 h
REFERENCE	ORD. NO. BASE WITH STEEL PLATE	DIM. mm
4	F CE G055 00 04	1065x625x56 h

ADDITIONAL STEEL SHELVES

ORD. NO.	LOAD CAPACITY kg	FOR TROLLEYS DIM. mm
F CF 0530 00 04	100	1135x625

Dimensions mm 999x610x30 h



ORD. NO.

F CF 0600 00 07

Smooth rubber for trolleys. Dimensions mm 1135x625

CONTAINER RETAINERS

ORD. NO.	SUITABLE FOR	FOR TROLLEYS DIM. mm
F CF 0905 00 99	Steel shelf	1135x625
F CF 0906 00 99	Wooden shelf	1135x625
F CF 0907 00 99	Steel and wooden bases	1135x625

Dimensions mm 995x60

Order no. FCF 0907 00 99 can only be ordered with the base.



ADDITIONAL WOODEN SHELVES

ORD. NO.	LOAD CAPACITY kg	FOR TROLLEYS DIM. mm
F CF 0580 00 04	100	1135x625

Dimensions mm 995x600x20 h



ADDITIONAL WOODEN TRAYS

ORD. NO.	LOAD CAPACITY kg	FOR TROLLEYS DIM. mm
F CF 0810 00 04	100	1135x625

Dimensions mm 995x610x65 h. Internal dimensions mm 960x580x45 h



RAL 5012 F.04 RAL 6011 F.02

KEY

■ Wheels see page E2-E7

■ All indicated loads are net and refer to evenly distributed weights

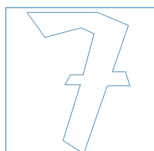

WIDTH = 1135 mm DEPTH = 625 mm HEIGHT (H) = 1045 mm

TROLLEYS SERIES COMBI CF2

MESHES FOR FRONTS

ORD. NO.	FOR TROLLEYS DIM. mm	MESH HOLE mm
F CF 0630 00 04	1135x625	50x100

Dimensions mm 484x680

Single item delivered with 4 clamps



■ 04
■ 02

MESHES FOR SIDES

ORD. NO.	FOR TROLLEYS DIM. mm	MESH HOLE mm
F CF 0705 00 04	1135x625	50x100

Dimensions mm 1000x680

Single item delivered with 4 clamps and bolts

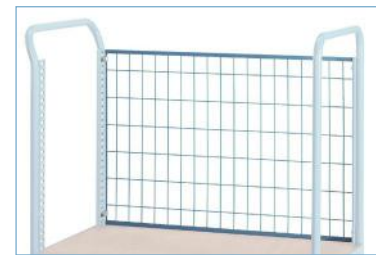

■ 04
■ 02

FORK LIFT BASE

ORD. NO.	DIMENSIONS mm
F CF 0965 00 04	238x615x70 h



■ 04
■ 02

■ INFO

RAL 5012 F.04 RAL 6011 F.02



www.famispa.com



TROLLEYS SERIES COMBI CL1

WIDTH = 945 mm DEPTH = 525 mm HEIGHT (H) = 1435 mm



RAL 5012 F.04

RAL 6011 F.02

INFO ■

www.famispa.com

WIDTH = 945 mm DEPTH = 525 mm HEIGHT (H) = 1435 mm

TROLLEYS SERIES COMBI CL1

04
02



ORD. NO.

F CL H006 04 04

Trolley with 2 standard rubber swivel wheels **with** brakes and 2 standard rubber fixed wheels Ø 150 mm
Load capacity: 250 kg
Dimensions mm 945x525x1435 h

04
02



ORD. NO.

F CL H006 06 04

Trolley with 2 standard rubber swivel wheels **with** brakes and 2 standard rubber fixed wheels Ø 150 mm
Load capacity: 250 kg
Dimensions mm 945x525x1435 h

04
02



ORD. NO.

F CL H006 07 04

Trolley with 2 standard rubber swivel wheels **with** brakes and 2 standard rubber fixed wheels Ø 150 mm
Load capacity: 250 kg
Dimensions mm 945x525x1435 h

04
02



ORD. NO.

F CL H006 10 04

Trolley with 2 standard rubber swivel wheels **with** brakes and 2 standard rubber fixed wheels Ø 150 mm
Load capacity: 250 kg
Dimensions mm 945x525x1435 h

04
02



ORD. NO.

F CL H005 04 04

Trolley with 2 standard rubber swivel wheels **with** brakes and 2 standard rubber fixed wheels Ø 150 mm
Load capacity: 250 kg
Dimensions mm 945x525x1435 h

04
02



ORD. NO.

F CL H005 05 04

Trolley with 2 standard rubber swivel wheels **with** brakes and 2 standard rubber fixed wheels Ø 150 mm
Load capacity: 250 kg
Dimensions mm 945x525x1435 h

04
02



With removable mesh side

ORD. NO.

F CL H005 03 04

Trolley with 2 standard rubber swivel wheels **with** brakes and 2 standard rubber fixed wheels Ø 150 mm
Load capacity: 250 kg
Dimensions mm 945x545x1435 h

KEY

RAL 5012 F.04 RAL 6011 F.02



- Shelves load capacity: 100 kg
- All indicated loads are net and refer to evenly distributed weights



TROLLEYS SERIES COMBI CL1

SIDE FRAMES WITH AND WITHOUT HANDLE, BASES WITH WOODEN PLATE, BASES WITH STEEL PLATE

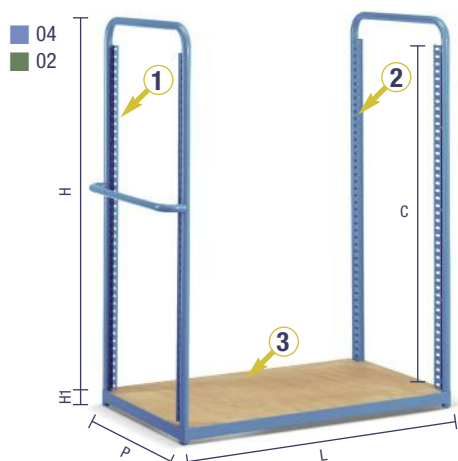

■	L = 945 mm
■	P = 525 mm
■	H = 1207 mm
■	H1 = 43 mm
■	C = 1100 mm

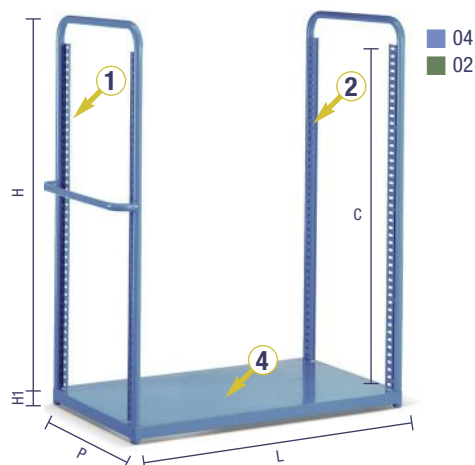

REFERENCE	ORD. NO. SIDE FRAME WITH HANDLE	DIM. mm
①	F CL 0605 00 04	521x105x1260 h

REFERENCE	ORD. NO. SIDE FRAME	DIM. mm
②	F CL 0615 00 04	521x30x1260 h

REFERENCE	ORD. NO. BASE WITH WOODEN PLATE	DIM. mm
③	F CE G006 00 04	865x525x56 h

REFERENCE	ORD. NO. BASE WITH STEEL PLATE	DIM. mm
④	F CE G005 00 04	865x525x56 h

ADDITIONAL STEEL SHELVES

ORD. NO.	LOAD CAPACITY kg	FOR TROLLEYS DIM. mm
F CF 0510 00 04	100	945x525

Dimensions mm 799x510x30 h



ORD. NO.

F CF 0590 00 07

Smooth rubber for trolleys. Dimensions mm 945x525

CONTAINER RETAINERS

ORD. NO.	SUITABLE FOR	FOR TROLLEYS DIM. mm
F CF 0900 00 99	Steel shelf	945x525
F CF 0901 00 99	Wooden shelf	945x525
F CF 0902 00 99	Steel and wooden bases	945x525

Dimensions mm 795x60

Order no. FCF 0902 00 99 can only be ordered with the base.



ADDITIONAL WOODEN SHELVES

ORD. NO.	LOAD CAPACITY kg	FOR TROLLEYS DIM. mm
F CF 0560 00 04	100	945x525

Dimensions mm 795x500x20 h



ADDITIONAL WOODEN TRAYS

ORD. NO.	LOAD CAPACITY kg	FOR TROLLEYS DIM. mm
F CF 0800 00 04	100	945x525

Dimensions mm 795x510x65 h. Internal dimensions mm 795x470x45 h



RAL 5012 F.04 RAL 6011 F.02

KEY ■

■ Wheels see page E2-E7

■ All indicated loads are net and refer to evenly distributed weights



WIDTH = 945 mm DEPTH = 525 mm HEIGHT (H) = 1435 mm

TROLLEYS SERIES COMBI CL1

MESHES FOR FRONTS

ORD. NO.	FOR TROLLEYS DIM. mm	MESH HOLE mm
F CL 0625 00 04	945x525	50x100

Dimensions mm 384x1095

Single item delivered with 4 clamps



■ 04
■ 02

MESHES FOR SIDES

ORD. NO.	FOR TROLLEYS DIM. mm	MESH HOLE mm
F CL 0700 00 04	945x525	50x100

Dimensions mm 800x1095

Two items delivered with 8 clamps and bolts



■ 04
■ 02



■ INFO

RAL 5012 F.04 RAL 6011 F.02



www.famispa.com



TROLLEYS SERIES COMBI CL2



RAL 5012 F.04 RAL 6011 F.02

INFO ■

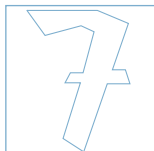

www.famispa.com



WIDTH = 1135 mm DEPTH = 625 mm HEIGHT (H) = 1535 mm

TROLLEYS SERIES COMBI CL2

04
02



ORD. NO.

F CL H056 04 04

Trolley with 2 standard rubber swivel wheels **with** brakes and 2 standard rubber fixed wheels Ø 150 mm
Load capacity: 250 kg
Dimensions mm 1135x625x1535 h

04
02



ORD. NO.

F CL H056 06 04

Trolley with 2 standard rubber swivel wheels **with** brakes and 2 standard rubber fixed wheels Ø 150 mm
Load capacity: 250 kg
Dimensions mm 1135x625x1535 h

04
02



ORD. NO.

F CL H056 07 04

Trolley with 2 standard rubber swivel wheels **with** brakes and 2 standard rubber fixed wheels Ø 150 mm
Load capacity: 250 kg
Dimensions mm 1135x625x1535 h

04
02



ORD. NO.

F CL H056 10 04

Trolley with 2 standard rubber swivel wheels **with** brakes and 2 standard rubber fixed wheels Ø 150 mm
Load capacity: 250 kg
Dimensions mm 1135x625x1535 h

04
02



ORD. NO.

F CL H055 04 04

Trolley with 2 standard rubber swivel wheels **with** brakes and 2 standard rubber fixed wheels Ø 150 mm
Load capacity: 250 kg
Dimensions mm 1135x625x1535 h

04
02



ORD. NO.

F CL H055 05 04

Trolley with 2 standard rubber swivel wheels **with** brakes and 2 standard rubber fixed wheels Ø 150 mm
Load capacity: 250 kg
Dimensions mm 1135x625x1535 h

04
02



With removable mesh side

ORD. NO.

F CL H055 03 04

Trolley with 2 standard rubber swivel wheels **with** brakes and 2 standard rubber fixed wheels Ø 150 mm
Load capacity: 250 kg
Dimensions mm 1135x645x1535 h

KEY

RAL 5012 F.04 RAL 6011 F.02



- Shelves load capacity: 100 kg
- All indicated loads are net and refer to evenly distributed weights



TROLLEYS SERIES COMBI CL2

SIDE FRAMES WITH AND WITHOUT HANDLE, BASES WITH WOODEN PLATE, BASES WITH STEEL PLATE

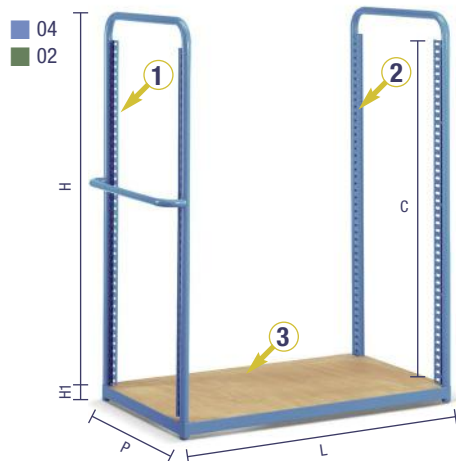

L	= 1135 mm
P	= 625 mm
H	= 1307 mm
H1	= 43 mm
C	= 1200 mm

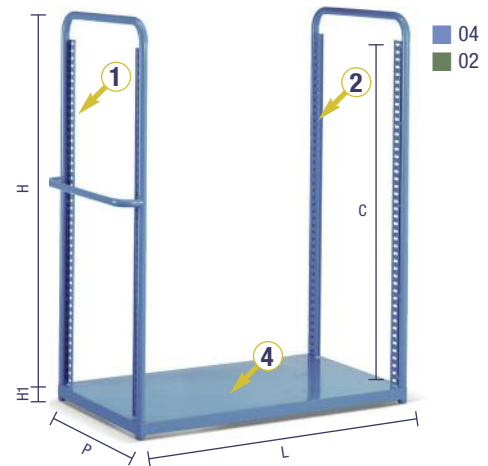

REFERENCE	ORD. NO. SIDE FRAME WITH HANDLE	DIM. mm
1	F CL 0610 00 04	621x105x1360 h

REFERENCE	ORD. NO. BASE WITH WOODEN PLATE	DIM. mm
3	F CE G056 00 04	1065x625x56 h

REFERENCE	ORD. NO. SIDE FRAME	DIM. mm
2	F CL 0620 00 04	621x30x1360 h

REFERENCE	ORD. NO. BASE WITH STEEL PLATE	DIM. mm
4	F CE G055 00 04	1065x625x56 h

ADDITIONAL STEEL SHELVES

ORD. NO.	LOAD CAPACITY kg	FOR TROLLEYS DIM. mm
F CF 0530 00 04	100	1135x625

Dimensions mm 999x610x30 h



ORD. NO.

F CF 0600 00 07

Smooth rubber for trolleys. Dimensions mm 1135x625

CONTAINER RETAINERS

ORD. NO.	SUITABLE FOR	FOR TROLLEYS DIM. mm
F CF 0905 00 99	Steel shelf	1135x625
F CF 0906 00 99	Wooden shelf	1135x625
F CF 0907 00 99	Steel and wooden bases	1135x625

Dimensions mm 995x60

Order no. FCF 0907 00 99 can only be ordered with the base.



ADDITIONAL WOODEN SHELVES

ORD. NO.	LOAD CAPACITY kg	FOR TROLLEYS DIM. mm
F CF 0580 00 04	100	1135x625

Dimensions mm 995x600x20 h



ADDITIONAL WOODEN TRAYS

ORD. NO.	LOAD CAPACITY kg	FOR TROLLEYS DIM. mm
F CF 0810 00 04	100	1135x625

Dimensions mm 995x610x65 h. Internal dimensions mm 960x580x45 h



RAL 5012 F.04 RAL 6011 F.02

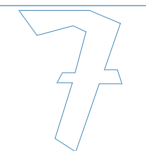

Wheels see page E2-E7

KEY

All indicated loads are net and refer to evenly distributed weights



WIDTH = 1135 mm DEPTH = 625 mm HEIGHT (H) = 1535 mm

TROLLEYS SERIES COMBI CL2

MESHES FOR FRONTS

ORD. NO.	FOR TROLLEYS DIM. mm	MESH HOLE mm
F CL 0630 00 04	1135x625	50x100
Dimensions mm 484x1200		
Single item delivered with 4 clamps		



■ 04
■ 02

MESHES FOR SIDES

ORD. NO.	FOR TROLLEYS DIM. mm	MESH HOLE mm
F CL 0705 00 04	1135x625	50x100
Dimensions mm 1000x1200		
Two items delivered with 8 clamps and bolts		



■ 04
■ 02

FORK LIFT BASE

ORD. NO.	DIMENSIONS mm
F CF 0965 00 04	238x615x70 h



■ 04
■ 02



■ INFO

RAL 5012 F. 04 RAL 6011 F. 02



www.famispa.com



TROLLEYS SERIES COMBI CI



RAL 5012 F.04

RAL 6011 F.02

INFO ■

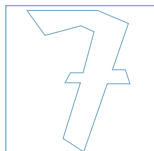

www.famispa.com



WIDTH = 1424 mm DEPTH = 825 mm HEIGHT (H) = 1200 mm

TROLLEYS SERIES COMBI CI



With removable mesh side

■ 04
■ 02

ORD. NO.

F CI P255 04 04

Trolley with 2 standard rubber swivel wheels **with** brakes and 2 standard rubber fixed wheels **Ø 200 mm**
Load capacity: 500 kg
Dimensions mm 1425x845x1200 h



With removable mesh side

■ 04
■ 02

ORD. NO.

F CI P256 04 04

Trolley with 2 standard rubber swivel wheels **with** brakes and 2 standard rubber fixed wheels **Ø 200 mm**
Load capacity: 500 kg
Dimensions mm 1425x845x1200 h



■ 04
■ 02

ORD. NO.

F CI P256 06 04

Trolley with 2 standard rubber swivel wheels **with** brakes and 2 standard rubber fixed wheels **Ø 200 mm**
Load capacity: 500 kg
Dimensions mm 1425x825x1200 h



■ 04
■ 02

ORD. NO.

F CI P256 03 04

Trolley with 2 standard rubber swivel wheels **with** brakes and 2 standard rubber fixed wheels **Ø 200 mm**
Load capacity: 500 kg
Dimensions mm 1425x825x1200 h



■ 04
■ 02

ORD. NO.

F CI P256 05 04

Trolley with 2 standard rubber swivel wheels **with** brakes and 2 standard rubber fixed wheels **Ø 200 mm**
Load capacity: 500 kg
Dimensions mm 1425x825x1200 h



■ 04
■ 02

ORD. NO.

F CI P255 03 04

Trolley with 2 standard rubber swivel wheels **with** brakes and 2 standard rubber fixed wheels **Ø 200 mm**
Load capacity: 500 kg
Dimensions mm 1425x825x1200 h



■ 04
■ 02

ORD. NO.

F CI P255 05 04

Trolley with 2 standard rubber swivel wheels **with** brakes and 2 standard rubber fixed wheels **Ø 200 mm**
Load capacity: 500 kg
Dimensions mm 1425x825x1200 h



■ 04
■ 02

ORD. NO.

F CI P255 06 04

Trolley with 2 standard rubber swivel wheels **with** brakes and 2 standard rubber fixed wheels **Ø 200 mm**
Load capacity: 500 kg
Dimensions mm 1425x825x1200 h

■ KEY

RAL 5012 F. 04 RAL 6011 F. 02



- Shelves load capacity: 100 kg
- All indicated loads are net and refer to evenly distributed weights



TROLLEYS SERIES COMBI CI

SIDE FRAMES WITH AND WITHOUT HANDLE, BASES WITH WOODEN PLATE, BASES WITH STEEL PLATE

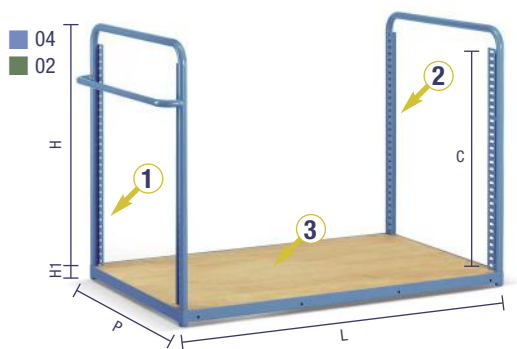

- L = 1425 mm
- P = 825 mm
- H = 915 mm
- H1 = 43 mm
- C = 850 mm

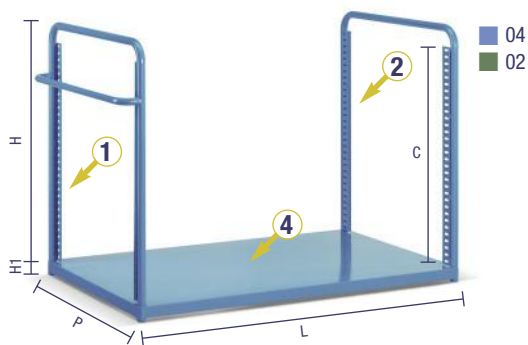

REFERENCE	ORD. NO. SIDE FRAME WITH HANDLE	DIM. mm
①	F CI 0605 00 04	821x105x970 h

REFERENCE	ORD. NO. BASE WITH WOODEN PLATE	DIM. mm
③	F CE N256 00 04	1345x825x56 h

REFERENCE	ORD. NO. SIDE FRAME	DIM. mm
②	F CI 0615 00 04	821x30x970 h

REFERENCE	ORD. NO. BASE WITH STEEL PLATE	DIM. mm
④	F CE N255 00 04	1345x825x56 h

ADDITIONAL WOODEN SHELVES

ORD. NO.	LOAD CAPACITY kg	FOR TROLLEYS DIM. mm
F CI 0560 00 04	100	1425x825

Dimensions mm 1280x800x20 h



CONTAINER RETAINERS

ORD. NO.	SUITABLE FOR	FOR TROLLEYS DIM. mm
F CG 0911 00 99	Wooden plate	1425x825
F CG 0912 00 99	Steel and wooden plates	1425x825

Dimensions mm 1275x60

Order no. FCG 0912 00 99 can only be ordered with the base.



FORK LIFT BASE

ORD. NO.	DIMENSIONS mm
F CI 0960 00 04	238x815x70 h



RAL 5012 F.04 RAL 6011 F.02

KEY ■

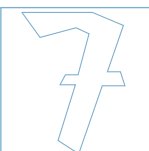

■ Wheels see page E2-E7

■ All indicated loads are net and refer to evenly distributed weights



WIDTH = 1424 mm DEPTH = 825 mm HEIGHT (H) = 1200 mm

TROLLEYS SERIES COMBI CI

MESHES FOR FRONTS

ORD. NO.	FOR TROLLEYS DIM. mm	MESH HOLE mm
F CI 0625 00 04	1425x825	100x100

Dimensions mm 684x810

Single item delivered with 4 clamps



■ 04
■ 02

MESHES FOR SIDES

ORD. NO.	FOR TROLLEYS DIM. mm	MESH HOLE mm
F CI 0700 00 04	1425x825	100x100

Dimensions mm 1280x810

Single item delivered with 4 clamps and bolts



■ 04
■ 02



■ INFO

RAL 5012 F.04

RAL 6011 F.02



www.famispa.com



TROLLEYS SERIES COMBI CK



RAL 5012 F.04

RAL 6011 F.02

INFO ■

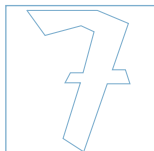

www.famispa.com



WIDTH = 1424 mm DEPTH = 825 mm HEIGHT (H) = 1800 mm

TROLLEYS SERIES COMBI CK



ORD. NO.

F CK P256 04 04

Trolley with 2 standard rubber swivel wheels **with** brakes and 2 standard rubber fixed wheels **Ø 200 mm**
Load capacity: 500 kg
Dimensions mm 1425x845x1800 h



ORD. NO.

F CK P255 04 04

Trolley with 2 standard rubber swivel wheels **with** brakes and 2 standard rubber fixed wheels **Ø 200 mm**
Load capacity: 500 kg
Dimensions mm 1425x845x1800 h



ORD. NO.

F CK P256 03 04

Trolley with 2 standard rubber swivel wheels **with** brakes and 2 standard rubber fixed wheels **Ø 200 mm**
Load capacity: 500 kg
Dimensions mm 1425x825x1800 h



ORD. NO.

F CK P256 06 04

Trolley with 2 standard rubber swivel wheels **with** brakes and 2 standard rubber fixed wheels **Ø 200 mm**
Load capacity: 500 kg
Dimensions mm 1425x825x1800 h



ORD. NO.

F CK P255 05 04

Trolley with 2 standard rubber swivel wheels **with** brakes and 2 standard rubber fixed wheels **Ø 200 mm**
Load capacity: 500 kg
Dimensions mm 1425x825x1800 h



ORD. NO.

F CK P255 07 04

Trolley with 2 standard rubber swivel wheels **with** brakes and 2 standard rubber fixed wheels **Ø 200 mm**
Load capacity: 500 kg
Dimensions mm 1425x825x1800 h

■ KEY



- Shelves load capacity: 100 kg
- All indicated loads are net and refer to evenly distributed weights

RAL 5012 F. 04 RAL 6011 F. 02



TROLLEYS SERIES COMBI CK

SIDE FRAMES WITH AND WITHOUT HANDLE, BASES WITH WOODEN PLATE, BASES WITH STEEL PLATE

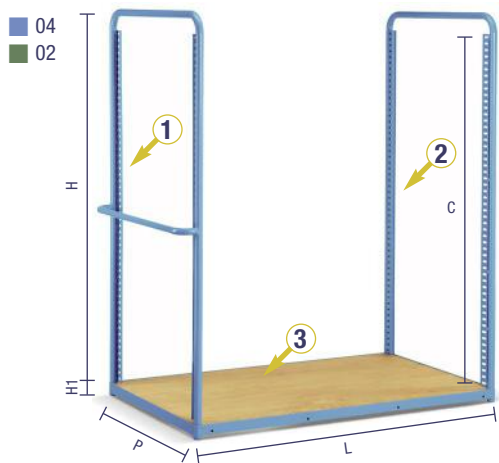

- L = 1425 mm
- P = 825 mm
- H = 1515 mm
- H1 = 43 mm
- C = 1435 mm

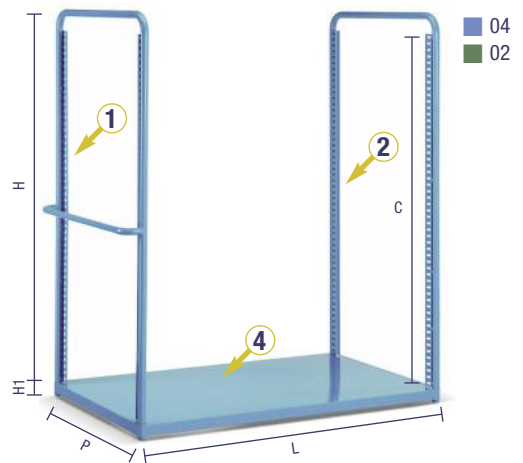

REFERENCE	ORD. NO. SIDE FRAME WITH HANDLE	DIM. mm
1	F CK 0605 00 04	821x105x1570 h

REFERENCE	ORD. NO. BASE WITH WOODEN PLATE	DIM. mm
3	F CE N256 00 04	1345x825x56 h

REFERENCE	ORD. NO. SIDE FRAME	DIM. mm
2	F CK 0615 00 04	821x30x1570 h

REFERENCE	ORD. NO. BASE WITH STEEL PLATE	DIM. mm
4	F CE N255 00 04	1345x825x56 h

ADDITIONAL WOODEN SHELVES

ORD. NO.	LOAD CAPACITY kg	FOR TROLLEYS DIM. mm
F CI 0560 00 04	100	1425x825

Dimensions mm 1280x800x20 h



CONTAINER RETAINERS

ORD. NO.	SUITABLE FOR	FOR TROLLEYS DIM. mm
F CG 0911 00 99	Wooden shelf	1425x825
F CG 0912 00 99	Steel and wooden bases	1425x825

Dimensions mm 1275x60

Order no. FCG 0912 00 99 can only be ordered with the base.



FORK LIFT BASE

ORD. NO.	DIMENSIONS mm
F CI 0960 00 04	238x815x70 h



RAL 5012 F.04 RAL 6011 F.02

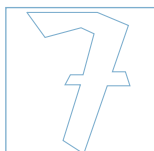

■ Wheels see page E2-E7

KEY ■

■ All indicated loads are net and refer to evenly distributed weights



WIDTH = 1424 mm DEPTH = 825 mm HEIGHT (H) = 1800 mm

TROLLEYS SERIES COMBI CK

MESHES FOR FRONTS

ORD. NO.	FOR TROLLEYS DIM. mm	MESH HOLE mm
F CK 0625 00 04	1425x825	100x100

Dimensions mm 684x1405

Single item delivered with 4 clamps

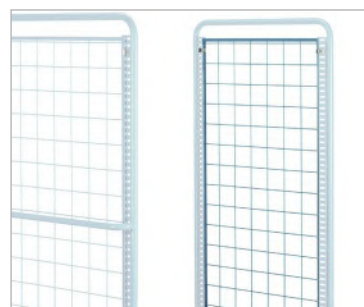

MESHES FOR SIDES

ORD. NO.	FOR TROLLEYS DIM. mm	MESH HOLE mm
F CK 0700 00 04	1425x825	100x100

Dimensions mm 1280x1405

Two items delivered with 8 clamps and bolts

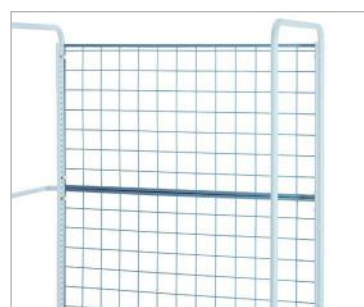

■ INFO

RAL 5012 F.04 RAL 6011 F.02



www.famispa.com



TROLLEYS SERIES COMBI CG



RAL 5012 F.04

RAL 6011 F.02

INFO ■

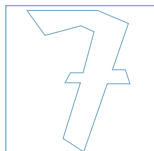

www.famispa.com



WIDTH = 1425 mm DEPTH = 525 mm HEIGHT (H) = 1490 mm

TROLLEYS SERIES COMBI CG



■ 04
■ 02

ORD. NO.

F CG P156 10 04

Trolley with 2 standard rubber swivel wheels **with** brakes and 2 standard rubber fixed wheels **Ø 200 mm**

Load capacity: 500 kg

Dimensions mm 1425x525x1490 h



■ 04
■ 02

ORD. NO.

F CG P155 05 04

Trolley with 2 standard rubber swivel wheels **with** brakes and 2 standard rubber fixed wheels **Ø 200 mm**

Load capacity: 500 kg

Dimensions mm 1425x525x1490 h



■ 04
■ 02

ORD. NO.

F CG P156 05 04

Trolley with 2 standard rubber swivel wheels **with** brakes and 2 standard rubber fixed wheels **Ø 200 mm**

Load capacity: 500 kg

Dimensions mm 1425x525x1490 h



■ 04
■ 02

ORD. NO.

F CG P155 07 04

Trolley with 2 standard rubber swivel wheels **with** brakes and 2 standard rubber fixed wheels **Ø 200 mm**

Load capacity: 500 kg

Dimensions mm 1425x525x1490 h



■ 04
■ 02

With 1 galvanised rear upstand

ORD. NO.

F CG P156 13 04

Trolley with 2 standard rubber swivel wheels **with** brakes and 2 standard rubber fixed wheels **Ø 200 mm**

Load capacity: 500 kg

Dim. mm 1425x525x1490 h Containers excluded

ORD. NO. **F CG P156 19 04**

Complete with 20 containers ord. no. F PM 6551 00 05



■ 04
■ 02

With 1 galvanised rear upstand

ORD. NO.

F CG P156 17 04

Trolley with 2 standard rubber swivel wheels **with** brakes and 2 standard rubber fixed wheels **Ø 200 mm**

Load capacity: 500 kg

Dim. mm 1425x525x1490 h Containers excluded

ORD. NO. **F CG P156 18 04**

Complete with 24 containers ord. no. F PM 5751 00 05



■ 04
■ 02

With removable mesh side

ORD. NO.

F CG P155 04 04

Trolley with 2 standard rubber swivel wheels **with** brakes and 2 standard rubber fixed wheels **Ø 200 mm**

Load capacity: 500 kg

Dimensions mm 1425x545x1490 h

■ KEY



- Shelves load capacity: 100 kg
- All indicated loads are net and refer to evenly distributed weights

RAL 5012 F. 04 RAL 6011 F. 02



TROLLEYS SERIES COMBI CG

SIDE FRAMES WITH AND WITHOUT HANDLE, BASES WITH WOODEN PLATE, BASES WITH STEEL PLATE

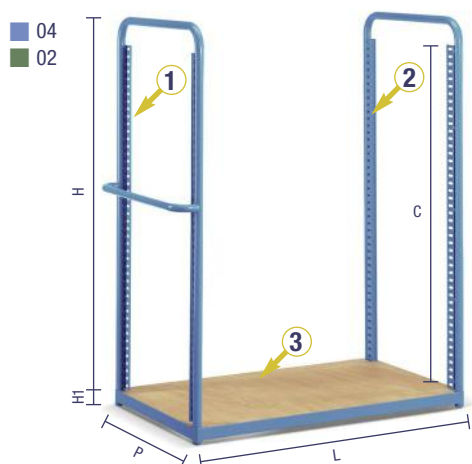

- L = 1425 mm
- P = 525 mm
- H = 1205 mm
- H1 = 43 mm
- C = 1100 mm

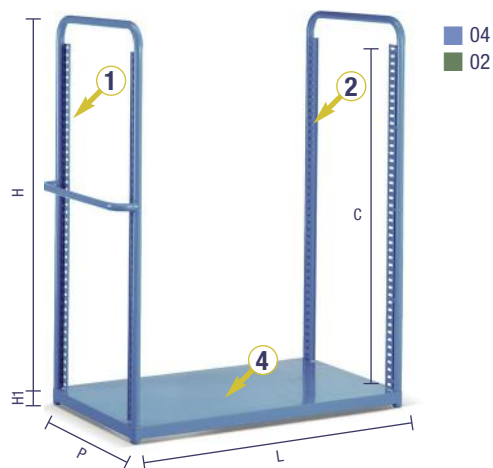

REFERENCE	ORD. NO. SIDE FRAME WITH HANDLE	DIM. mm
①	F CL 0605 00 04	521x105x1260 h
REFERENCE	ORD. NO. BASE WITH WOODEN PLATE	DIM. mm
③	F CE N156 00 04	1345x525x56 h

REFERENCE	ORD. NO. SIDE FRAME	DIM. mm
②	F CL 0615 00 04	521x30x1260 h
REFERENCE	ORD. NO. BASE WITH STEEL PLATE	DIM. mm
④	F CE N155 00 04	1345x525x56 h

ADDITIONAL STEEL SHELVES

ORD. NO.	LOAD CAPACITY kg	FOR TROLLEYS DIM. mm
F CG 0510 00 04	100	1425x525

Dimensions mm 1283x510x30 h



ORD. NO.

F CG 0590 00 07

Smooth rubber for trolleys. Dimensions mm 1425x525

CONTAINER RETAINERS

ORD. NO.	SUITABLE FOR	FOR TROLLEYS DIM. mm
F CG 0910 00 99	Steel shelf	1425x525
F CG 0912 00 99	Steel and wooden bases	1425x525

Dimensions mm 1275x60

Order no. FCG 0912 00 99 can only be ordered with the base.



ADDITIONAL WOODEN SHELVES

ORD. NO.	LOAD CAPACITY kg	FOR TROLLEYS DIM. mm
F CG 0560 00 04	100	1425x525

Dimensions mm 1260x500x12 h



RAL 5012 F.04 RAL 6011 F.02

KEY

■ Wheels see page E2-E7

■ All indicated loads are net and refer to evenly distributed weights



WIDTH = 1425 mm DEPTH = 525 mm HEIGHT (H) = 1490 mm

TROLLEYS SERIES COMBI CG

MESHES FOR FRONTS

ORD. NO.	FOR TROLLEYS DIM. mm	MESH HOLE mm
F CL 0625 00 04	1425x525	50x100

Dimensions mm 384x1095

Single item delivered with 4 clamps



04
02

MESHES FOR SIDES

ORD. NO.	FOR TROLLEYS DIM. mm	MESH HOLE mm
F CG 0700 00 04	1425x525	50x100

Dimensions mm 1280x1095

Two items delivered with 8 clamps and bolts



04
02

FORK LIFT BASE

ORD. NO.	DIMENSIONS mm
F CF 0960 00 04	238x515x70 h



04
02



■ INFO

RAL 5012 F. 04 RAL 6011 F. 02



www.famispa.com



TROLLEYS SERIES COMBI CH



RAL 5012 F.04

RAL 6011 F.02

INFO ■

www.famispa.com

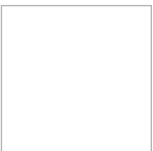
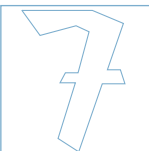

WIDTH = 1425 mm DEPTH = 625 mm HEIGHT (H) = 1590 mm

TROLLEYS SERIES COMBI CH



04
02

ORD. NO.

F CH P205 07 04

Trolley with 2 standard rubber swivel wheels **with** brakes and 2 standard rubber fixed wheels \varnothing 200 mm

Load capacity: 500 kg

Dimensions mm 1425x625x1590 h



04
02



04
02



04
02

ORD. NO.

F CH P206 11 04

Trolley with 2 standard rubber swivel wheels **with** brakes and 2 standard rubber fixed wheels \varnothing 200 mm

Load capacity: 500 kg

Dimensions mm 1425x625x1590 h

ORD. NO.

F CH P206 09 04

Trolley with 2 standard rubber swivel wheels **with** brakes and 2 standard rubber fixed wheels \varnothing 200 mm

Load capacity: 500 kg

Dimensions mm 1425x625x1590 h

ORD. NO.

F CH P205 05 04

Trolley with 2 standard rubber swivel wheels **with** brakes and 2 standard rubber fixed wheels \varnothing 200 mm

Load capacity: 500 kg

Dimensions mm 1425x625x1590 h



04
02

With 1 galvanised rear upstand



04
02

With 1 galvanised rear upstand



04
02

With removable mesh side

ORD. NO.

F CH P206 12 04

Trolley with 2 standard rubber swivel wheels **with** brakes and 2 standard rubber fixed wheels \varnothing 200 mm

Load capacity: 500 kg

Dim. mm 1425x625x1590 h Containers excluded

ORD. NO.

F CH P206 15 04

Trolley with 2 standard rubber swivel wheels **with** brakes and 2 standard rubber fixed wheels \varnothing 200 mm

Load capacity: 500 kg

Dim. mm 1425x625x1590 h Containers excluded

ORD. NO.

F CH P205 04 04

Trolley with 2 standard rubber swivel wheels **with** brakes and 2 standard rubber fixed wheels \varnothing 200 mm

Load capacity: 500 kg

Dimensions mm 1425x645x1590 h

ORD. NO. **F CH P206 14 04**

Complete with 12 containers ord. no. F PA 6451 A0 01

ORD. NO. **F CH P206 16 04**

Complete with 9 containers ord. no. F PA 6851 A0 01

KEY

RAL 5012 F. 04

RAL 6011 F. 02



- Shelves load capacity: 100 kg
- All indicated loads are net and refer to evenly distributed weights



TROLLEYS SERIES COMBI CH

SIDE FRAMES WITH AND WITHOUT HANDLE, BASES WITH WOODEN PLATE, BASES WITH STEEL PLATE

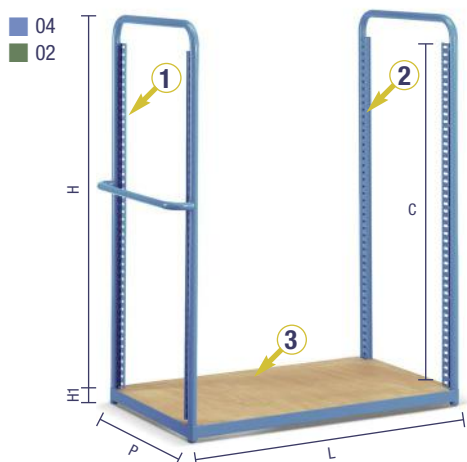

- L = 1425 mm
- P = 625 mm
- H = 1305 mm
- H1 = 43 mm
- C = 1200 mm

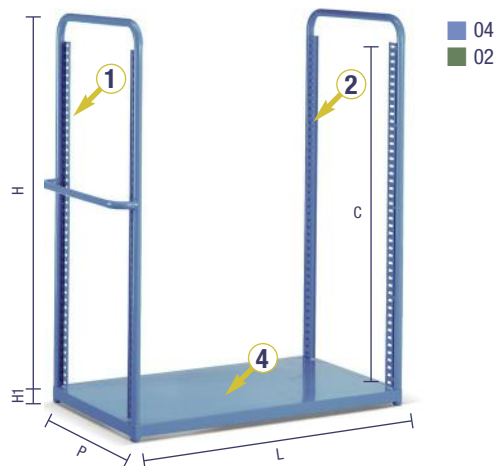

REFERENCE	ORD. NO. SIDE FRAME WITH HANDLE	DIM. mm
①	F CL 0610 00 04	621x105x1360 h
REFERENCE	ORD. NO. BASE WITH WOODEN PLATE	DIM. mm
③	F CE N206 00 04	1345x625x56 h

REFERENCE	ORD. NO. SIDE FRAME	DIM. mm
②	F CL 0620 00 04	621x30x1360 h
REFERENCE	ORD. NO. BASE WITH STEEL PLATE	DIM. mm
④	F CE N205 00 04	1345x625x56 h

ADDITIONAL STEEL SHELVES

ORD. NO.	LOAD CAPACITY kg	FOR TROLLEYS DIM. mm
F CH 0510 00 04	100	1425x625

Dimensions mm 1283x610x30 h



ORD. NO.

F CH 0590 00 07

Smooth rubber for trolleys. Dimensions mm 1425x625

CONTAINER RETAINERS

ORD. NO.	SUITABLE FOR	FOR TROLLEYS DIM. mm
F CG 0910 00 99	Steel shelf	1425x625
F CG 0912 00 99	Steel and wooden bases	1425x625

Dimensions mm 1275x60

Order no. FCG 0912 00 99 can only be ordered with the base.



ADDITIONAL WOODEN SHELVES

ORD. NO.	LOAD CAPACITY kg	FOR TROLLEYS DIM. mm
F CH 0560 00 04	100	1425x625

Dimensions mm 1260x600x12 h



RAL 5012 F.04 RAL 6011 F.02

KEY ■

■ Wheels see page E2-E7

■ All indicated loads are net and refer to evenly distributed weights



WIDTH = 1425 mm DEPTH = 625 mm HEIGHT (H) = 1590 mm

TROLLEYS SERIES COMBI CH

MESHES FOR FRONTS

ORD. NO.	FOR TROLLEYS DIM. mm	MESH HOLE mm
F CL 0630 00 04	1425x625	50x100

Dimensions mm 484x1200

Single item delivered with 4 clamps



■ 04
■ 02

MESHES FOR SIDES

ORD. NO.	FOR TROLLEYS DIM. mm	MESH HOLE mm
F CH 0700 00 04	1425x625	50x100

Dimensions mm 1280x1200

Two items delivered with 8 clamps and bolts



■ 04
■ 02

FORK LIFT BASE

ORD. NO.	DIMENSIONS mm
F CF 0965 00 04	238x615x70 h



■ 04
■ 02



■ INFO

RAL 5012 F.04 RAL 6011 F.02



www.famispa.com



TROLLEYS SERIES COMBI CR



■ All the FCR series trolleys are supplied assembled

TROLLEYS F CR 0091



ORD. NO.

■ 02 ■ 04

F CR 0091 00 04

Trolley with 2 standard rubber swivel wheels **with** brakes and 2 standard rubber fixed wheels \varnothing 100 mm
Load capacity: 150 kg
Dimensions mm 920x510x810 h



ORD. NO.

■ 02 ■ 04

F CR 0091 01 04

Trolley with 2 standard rubber swivel wheels **with** brakes and 2 standard rubber fixed wheels \varnothing 100 mm
Load capacity: 150 kg
Dimensions mm 920x510x810 h

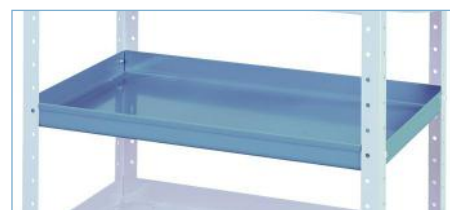
EXTRA STEEL SHELVES
FOR TROLLEYS F CR 0091

ORD. NO.

■ 02 ■ 04

F CR 0715 00 04

Load capacity: 100 kg
Dimensions mm 810x510x54 h

TROLLEYS F CR 0071



ORD. NO.

■ 02 ■ 04

F CR 0071 00 04

Trolley with 2 standard rubber swivel wheels **with** brakes and 2 standard rubber fixed wheels \varnothing 100 mm
Load capacity: 300 kg
Dimensions mm 840x590x955 h



ORD. NO.

■ 02 ■ 04

F CR 0071 01 04

Trolley with:
2 standard rubber swivel wheels **with** brakes
2 standard rubber fixed wheels \varnothing 125 mm
1 storage container ord. no. F PL 8951 00 03 red
1 storage container ord. no. F PL 8951 00 05 yellow
Load capacity: 300 kg
Dimensions mm 840x590x955 h



ORD. NO.

■ 02 ■ 04

F CR 0071 02 04

Trolley with:
2 standard rubber swivel wheels **with** brakes
2 standard rubber fixed wheels \varnothing 125 mm
2 storage containers ord. no. F PM 6551 00 03 red
2 storage containers ord. no. F PM 6551 00 05 yellow
Load capacity: 300 kg
Dimensions mm 840x590x955 h

TROLLEYS SERIES COMBI CR

TROLLEYS F CR 0031



ORD. NO.

■ 02 ■ 04

F CR 0031 00 04

Trolley with 2 standard rubber swivel wheels **with** brakes and 2 standard rubber fixed wheels **Ø 125 mm**

Load capacity: 300 kg

Dimensions mm 765x560x1030 h



ORD. NO.

■ 02 ■ 04

F CR 0031 02 04

Trolley with:

2 standard rubber swivel wheels **with** brakes

2 standard rubber fixed wheels **Ø 125 mm**

2 storage containers ord. no. F PM 6551 00 03 red

2 storage containers ord. no. F PM 6551 00 05 yellow

Load capacity: 300 kg

Dimensions mm 765x560x1030 h



ORD. NO.

■ 02 ■ 04

F CR 0031 03 04

Trolley with:

2 standard rubber swivel wheels **with** brakes

2 standard rubber fixed wheels **Ø 125 mm**

1 storage container ord. no. F PL 8951 00 03 red

1 storage container ord. no. F PL 8951 00 05 yellow

Load capacity: 300 kg

Dimensions mm 765x560x1030 h

TROLLEYS F CR 0021



ORD. NO.

■ 02 ■ 04

F CR 0021 00 04

Trolley with 4 standard rubber swivel wheels **without** brakes **Ø 100 mm**

Load capacity: 150 kg

Dimensions mm 555x445x845 h



ORD. NO.

■ 02 ■ 04

F CR 0021 01 04

Trolley with:

4 standard rubber swivel wheels **without** brakes

Ø 100 mm

2 storage containers ord. no. F PM 4151 00 03 red

2 storage containers ord. no. F PM 4151 00 05 yellow

Load capacity: 150 kg

Dimensions mm 555x445x845 h



ORD. NO.

■ 02 ■ 04

F CR 0021 03 04

Trolley with:

4 standard rubber swivel wheels **without** brakes

Ø 100 mm

1 storage container ord. no. F PM 6551 00 05 yellow

1 storage container ord. no. F PM 6551 00 04 blue

Load capacity: 150 kg

Dimensions mm 555x445x845 h

TROLLEY F CR 0090 WITHOUT WHEELS



ORD. NO.

■ 02 ■ 04

F CR 0090 00 04

Trolley suitable for wheels **Ø 100-125-150**

Dimensions mm 920x510x680 h

TROLLEY F CR 0070 WITHOUT WHEELS



ORD. NO.

■ 02 ■ 04

F CR 0070 00 04

Trolley suitable for wheels **Ø 100-125-150**

Dimensions mm 840x590x800 h

TROLLEY F CR 0030 WITHOUT WHEELS



ORD. NO.

■ 02 ■ 04

F CR 0030 00 04

Trolley suitable for wheels **Ø 100-125-150**

Dimensions mm 765x560x875 h

TROLLEYS SERIES COMBI CP1



TROLLEYS WITH WHEELS



ORD. NO.

F CP 2011 01 99

Trolley with 4 standard rubber swivel wheels
without brakes Ø 100 mm

Load capacity: 150 kg

Dim. mm 615x415x170 h

Standard colour:

■ GALVANISED F. 99



ORD. NO.

F CP 2011 02 99

Trolley with 4 standard rubber swivel wheels
without brakes Ø 100 mm

Load capacity: 150 kg

Dim. mm 695x415x170/870 h

Standard colour:

■ GALVANISED F. 99

TROLLEYS WITHOUT WHEELS



ORD. NO.

F CP 2010 00 99

Trolley suitable for wheels Ø 100-125-150

Dim. mm 615x415x40 h

Standard colour:

■ GALVANISED F. 99



ORD. NO.

F CP 2010 03 99

Trolley suitable for wheels Ø 100-125-150

Dim. mm 695x415x740 h

Standard colour:

■ GALVANISED F. 99

GALVANISED F. 99

SUPPLEMENTARY PARTS



■ Wheels see
page E2-E7



■ Trolleys FC P are supplied with 4 rubber swivel wheels without brakes



HEIGHT = 1430 mm DEPTH = 613 mm

TROLLEYS SERIES SMART



TROLLEY WITHOUT CONTAINERS

ORD. NO.	DIMENSIONS mm
F LB B073 05 52	725x613x1430 h
Complete with:	
3 shelves depth 420 mm (A=687 mm)	
2 standard rubber swivel wheels with brakes	
2 standard rubber fixed wheels Ø 125 mm	
Load capacity: 300 kg (150 kg per side)	
Standard colour:	
■ GALVANISED + RAL 7000 F..... 52	

TROLLEY WITH CONTAINERS

ORD. NO.	DIMENSIONS mm
F LB B073 55 52	725x613x1430 h
Complete with:	
1 trolley ord. no. F LB B073 05 52	
4 storage containers ord. no. F PA 4451 A0 01	
1 storage container ord. no. F PA 6451 A0 01	
1 storage container ord. no. F PA 6851 A0 01	

■ For further information on SMART trolleys go to the Unimod section on page D2



TROLLEY WITHOUT CONTAINERS

ORD. NO.	DIMENSIONS mm
F LB B103 02 52	1023x613x1430 h
Complete with:	
3 shelves depth 600 mm (A=985 mm)	
2 standard rubber swivel wheels with brakes	
2 standard rubber fixed wheels Ø 125 mm	
Load capacity: 300 kg (150 kg per side)	
Standard colour:	
■ GALVANISED + RAL 7000 F..... 52	

TROLLEY WITH CONTAINERS

ORD. NO.	DIMENSIONS mm
F LB B103 52 52	1023x613x1430 h
Complete with:	
1 trolley ord. no. F LB B103 02 52	
4 storage containers ord. no. F PA 6451 A0 01	
2 storage containers ord. no. F PA 6851 A0 01	
1 storage container ord. no. F PA 8951 A0 01	

■ For further information on SMART trolleys go to the Unimod section on page D2



■ INFO

GALVANISED F.....99
RAL 7000 F.....01



SMART TROLLEYS ARE IN THE UNIMOD SECTION ON PAGE D2

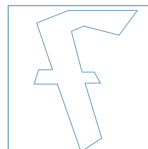

TROLLEYS SERIES SMART

WIDTH = 1023 mm DEPTH = 613 mm



■ For further information on SMART trolleys go to the Unimod section on page D2

TROLLEY WITH CONTAINERS

ORD. NO.	DIMENSIONS mm
F LB B102 52 52	1023x613x1430 h
Complete with:	
1 trolley ord. no. F LB B102 02 52	
180 containers size 1	

TROLLEY WITHOUT CONTAINERS

ORD. NO.	DIMENSIONS mm
F LB B102 02 52	1023x613x1430 h
Complete with:	
20 shelves for size 1	
2 standard rubber swivel wheels with brake	
2 standard rubber fixed wheels Ø 125 mm	
Load capacity: 300 kg (150 kg per side)	
Standard colour:	
■ GALVANISED + RAL 7000 F. 52	



■ For further information on SMART trolleys go to the Unimod section on page D2

TROLLEY WITH CONTAINERS

ORD. NO.	DIMENSIONS mm
F LB B102 53 52	1023x613x1430 h
Complete with:	
1 trolley ord. no. F LB B102 03 52	
90 containers size 1	
24 containers size 2	

TROLLEY WITHOUT CONTAINERS

ORD. NO.	DIMENSIONS mm
F LB B102 03 52	1023x613x1430 h
Complete with:	
10 shelves for size 1	
8 shelves for size 2	
2 standard rubber swivel wheels with brake	
2 standard rubber fixed wheels Ø 125 mm	
Load capacity: 300 kg (150 kg per side)	
Standard colour:	
■ GALVANISED + RAL 7000 F. 52	



GALVANISED F. 99
RAL 7000 F. 01

INFO ■

SMART TROLLEYS ARE IN THE
UNIMOD SECTION ON PAGE D2



WIDTH = 1023 mm DEPTH = 613 mm

TROLLEYS SERIES SMART



Rear

■ For further information on SMART trolleys go to the Unimod section on page D2

TROLLEY WITH CONTAINERS

ORD. NO.	DIMENSIONS mm
F LB B102 54 52	1023x613x1430 h
Complete with:	
1 trolley ord. no. F LB B102 04 52	
84 containers size 2	

TROLLEY WITHOUT CONTAINERS

ORD. NO.	DIMENSIONS mm
F LB B102 04 52	1023x613x1430 h
Complete with:	
14 shelves for size 2	
2 standard rubber swivel wheels with brake	
2 standard rubber fixed wheels Ø 125 mm	
Load capacity: 300 kg (150 kg per side)	
Standard colour:	
■ GALVANISED + RAL 7000 F. 52	



Rear

■ For further information on SMART trolleys go to the Unimod section on page D2

TROLLEY WITH CONTAINERS

ORD. NO.	DIMENSIONS mm
F LB B102 56 52	1023x613x1430 h
Complete with:	
1 trolley ord. no. F LB B102 06 52	
45 containers size 1	
24 containers size 2	
28 containers size 3A2	

TROLLEY WITHOUT CONTAINERS

ORD. NO.	DIMENSIONS mm
F LB B102 06 52	1023x613x1430 h
Complete with:	
5 shelves for size 1	
4 shelves for size 2	
6 shelves for size 3A2	
2 standard rubber swivel wheels with brake	
2 standard rubber fixed wheels Ø 125 mm	
Load capacity: 300 kg (150 kg per side)	
Standard colour:	
■ GALVANISED + RAL 7000 F. 52	



■ INFO

GALVANISED F. 99
RAL 7000 F. 01



SMART TROLLEYS ARE IN THE UNIMOD SECTION ON PAGE D2

