

STEEL WORK STATIONS

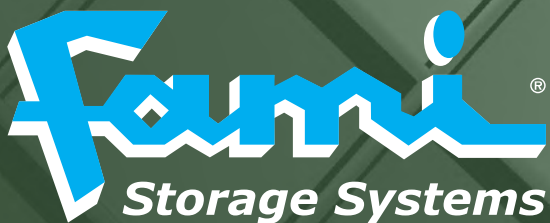

CATALOGUE NO.
C CT GB 316 00

MULTICOMPARTMENTS WORKSTATIONS



Order no.

F VW 0029 00 04

Dimensions mm 1000x700x900 h

Steel workstation with:

2 compartments with locks

2 drawers with locks and guides with bearings.

Drawer load capacity 20 kg.

Workstation load capacity 1000 kg.



Order no.

F VW 0030 00 04

Dimensions mm 2000x700x900 h

Steel workstation with:

4 compartments with locks

4 drawers with locks and guides with bearings.

Drawer load capacity 20 kg.

Workstation load capacity 1000 kg.



■ Steel workstations width 1000 mm with steel worktop	Page	4
■ Steel workstations width 1500 mm with steel worktop	Page	6
■ Steel workstations width 2000 mm with steel worktop	Page	8
■ Steel workstations width 2500 mm with steel worktop	Page	12
■ Steel workstations width 1000 mm with wooden worktop	Page	16
■ Steel workstations width 1500 mm with wooden worktop	Page	18
■ Steel workstations width 2000 mm with wooden worktop	Page	20
■ Steel workstations width 2500 mm with wooden worktop	Page	24
■ Components and accessories	Page	28





WORKSTATIONS WITH STEEL WORKTOP



STEEL WORKSTATIONS 1000

WITH STEEL WORKTOP

STANDARD
COLOUR
BLUE 04

■ RAL 5012

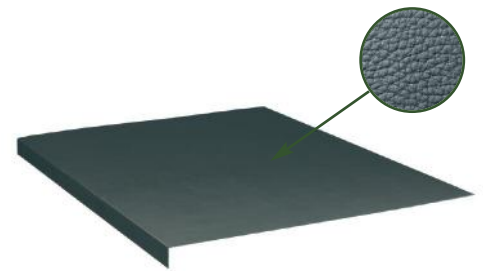

STEEL COVER WITH RUBBER COATING

Order no.

F BG 3210 00 07

Dimensions mm 1024x700x33 h

COLOUR BLACK



WORKSTATIONS

LOAD CAPACITY:

1000 KG



Order no.

F BG M100 00 04 ASSEMBLED

F BG S100 00 04 UNASSEMBLED

Dimensions mm 1031x705x855 h

■ 04



Order no.

F BG M100 01 04 ASSEMBLED

F BG S100 01 04 UNASSEMBLED

Dimensions mm 1031x705x855 h

■ 04

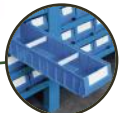

Detail of
Multibox

Order no.

F BG M100 52 04 ASSEMBLED

F BG S100 52 04 UNASSEMBLED

Dimensions mm 1031x705x855 h

■ 04 Complete with 10 Multibox with each 1 partition and 2 containers



Order no.

F BG M1A0 00 04 ASSEMBLED

F BG S1A0 00 04 UNASSEMBLED

Dimensions mm 1031x705x855 h

■ 04



Order no.

F BG M1B0 00 04 ASSEMBLED

F BG S1B0 00 04 UNASSEMBLED

Dimensions mm 1031x705x855 h

■ 04



Order no.

F BG M1C0 00 04 ASSEMBLED

F BG S1C0 00 04 UNASSEMBLED

Dimensions mm 1031x705x855 h

■ 04

STEEL WORKSTATIONS 1500

WITH STEEL WORKTOP



ORD. NO. Workstation **F BG M200 S1 04**
Complete with 32 Multibox and steel cover with rubber coating. Dimensions mm 1507x705x855 h.

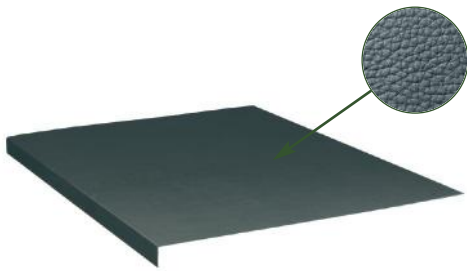

STEEL COVER WITH RUBBER COATING

Order no.
F BG 3215 00 07
Dimensions mm 1498x700x33 h
COLOUR BLACK



**WORKSTATIONS
LOAD CAPACITY:
1000 KG**



Order no.
F BG M200 00 04 ASSEMBLED
F BG S200 00 04 UNASSEMBLED
Dimensions mm 1507x705x855 h
■ 04



Order no.
F BG M2A0 00 04 ASSEMBLED
F BG S2A0 00 04 UNASSEMBLED
Dimensions mm 1507x705x855 h
■ 04



Order no.
F BG M2C0 00 04 ASSEMBLED
F BG S2C0 00 04 UNASSEMBLED
Dimensions mm 1507x705x855 h
■ 04



STEEL WORKSTATIONS 1500

WITH STEEL WORKTOP

STANDARD
COLOUR
BLUE 04

■ RAL 5012

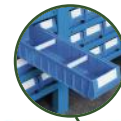

Detail of
Multibox



Order no.
F BG M2B0 00 04 ASSEMBLED
F BG S2B0 00 04 UNASSEMBLED
Dimensions mm 1507x705x855 h
■ 04



Order no.
F BG M2B0 01 04 ASSEMBLED
F BG S2B0 01 04 UNASSEMBLED
Dimensions mm 1507x705x855 h
■ 04



Order no.
F BG M2B0 52 04 ASSEMBLED
F BG S2B0 52 04 UNASSEMBLED
Dimensions mm 1507x705x855 h
■ 04 Complete with 10 Multibox with each 1 partition and 2 containers



Order no.
F BG M2AA 00 04 ASSEMBLED
F BG S2AA 00 04 UNASSEMBLED
Dimensions mm 1507x705x855 h
■ 04



Order no.
F BG M2AB 00 04 ASSEMBLED
F BG S2AB 00 04 UNASSEMBLED
Dimensions mm 1507x705x855 h
■ 04



Order no.
F BG M2AC 00 04 ASSEMBLED
F BG S2AC 00 04 UNASSEMBLED
Dimensions mm 1507x705x855 h
■ 04



Order no.
F BG M2BB 00 04 ASSEMBLED
F BG S2BB 00 04 UNASSEMBLED
Dimensions mm 1507x705x855 h
■ 04



Order no.
F BG M2BC 00 04 ASSEMBLED
F BG S2BC 00 04 UNASSEMBLED
Dimensions mm 1507x705x855 h
■ 04



Order no.
F BG M2CC 00 04 ASSEMBLED
F BG S2CC 00 04 UNASSEMBLED
Dimensions mm 1507x705x855 h
■ 04

STEEL WORKSTATIONS 2000

WITH STEEL WORKTOP

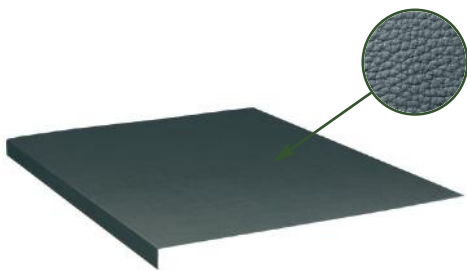

STEEL COVER WITH RUBBER COATING

Order no.
F BG 3220 00 07
 Dimensions mm 1998x700x33 h
 COLOUR BLACK



WORKSTATIONS
 LOAD CAPACITY:
 1000 KG



Order no.
F BG M300 00 04 ASSEMBLED
F BG S300 00 04 UNASSEMBLED
 Dimensions mm 2007x705x855 h

■ 04



Order no.
F BG M300 01 04 ASSEMBLED
F BG S300 01 04 UNASSEMBLED
 Dimensions mm 2007x705x855 h

■ 04





Order no.
F BG M300 52 04 ASSEMBLED
F BG S300 52 04 UNASSEMBLED
Dimensions mm 2007x705x855 h
 Complete with 22 Multibox with each 1 partition and 5 containers
 ■ 04



Order no.
F BG M3A0 00 04 ASSEMBLED
F BG S3A0 00 04 UNASSEMBLED
Dimensions mm 2007x705x855 h
 ■ 04



Order no.
F BG M3B0 00 04 ASSEMBLED
F BG S3B0 00 04 UNASSEMBLED
Dimensions mm 2007x705x855 h
 ■ 04



Order no.
F BG M3B0 01 04 ASSEMBLED
F BG S3B0 01 04 UNASSEMBLED
Dimensions mm 2007x705x855 h
 ■ 04



Order no.
F BG M3B0 52 04 ASSEMBLED
F BG S3B0 52 04 UNASSEMBLED
Dimensions mm 2007x705x855 h
 Complete with 16 Multibox with each 1 partition and 4 containers
 ■ 04



Order no.
F BG M3C0 00 04 ASSEMBLED
F BG S3C0 00 04 UNASSEMBLED
Dimensions mm 2007x705x855 h
 ■ 04

STEEL WORKSTATIONS 2000

WITH STEEL WORKTOP



Order no.
F BG M3AA 00 04 ASSEMBLED
F BG S3AA 00 04 UNASSEMBLED
 Dimensions mm 2007x705x855 h
 ■ 04



Order no.
F BG M3AA 01 04 ASSEMBLED
F BG S3AA 01 04 UNASSEMBLED
 Dimensions mm 2007x705x855 h
 ■ 04



Order no.
F BG M3AA 52 04 ASSEMBLED
F BG S3AA 52 04 UNASSEMBLED
 Dimensions mm 2007x705x855 h
 Complete with 16 Multibox with each 1 partition and 5 containers



Order no.
F BG M3AB 00 04 ASSEMBLED
F BG S3AB 00 04 UNASSEMBLED
 Dimensions mm 2007x705x855 h
 ■ 04



Order no.
F BG M3AC 00 04 ASSEMBLED
F BG S3AC 00 04 UNASSEMBLED
 Dimensions mm 2007x705x855 h
 ■ 04



Order no.
F BG M3BB 00 04 ASSEMBLED
F BG S3BB 00 04 UNASSEMBLED
 Dimensions mm 2007x705x855 h
 ■ 04





Order no.
F BG M3BC 00 04 ASSEMBLED
F BG S3BC 00 04 UNASSEMBLED
 Dimensions mm 2007x705x855 h
 ■ 04



Order no.
F BG M3BC 01 04 ASSEMBLED
F BG S3BC 01 04 UNASSEMBLED
 Dimensions mm 2007x705x855 h
 ■ 04



Order no.
F BG M3BC 52 04 ASSEMBLED
F BG S3BC 52 04 UNASSEMBLED
 Dimensions mm 2007x705x855 h
 Complete with 20 Multibox with each 1 partition
 ■ 04



Order no.
F BG M3CC 00 04 ASSEMBLED
F BG S3CC 00 04 UNASSEMBLED
 Dimensions mm 2007x705x855 h
 ■ 04



Order no.
F BG M3AA A0 04 ASSEMBLED
F BG S3AA A0 04 UNASSEMBLED
 Dimensions mm 2007x705x855 h
 ■ 04



Order no.
F BG M3AB A0 04 ASSEMBLED
F BG S3AB A0 04 UNASSEMBLED
 Dimensions mm 2007x705x855 h
 ■ 04

STEEL WORKSTATIONS 2500

WITH STEEL WORKTOP



ORD. NO. Workstation F BG M400 S1 04
Complete with 2 storage containers and steel cover with rubber coating.
Dimensions mm 2507x705x855 h.

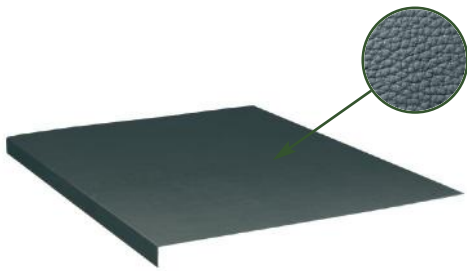

STEEL COVER WITH RUBBER COATING

Order no.
F BG 3225 00 07
Dimensions mm 2498x700x33 h
COLOUR BLACK



**WORKSTATIONS
LOAD CAPACITY:
1000 KG**



Order no.
F BG M400 00 04 **ASSEMBLED**
F BG S400 00 04 **UNASSEMBLED**
Dimensions mm 2507x705x855 h
■ 04





Order no.

F BG M4A0 00 04

ASSEMBLED

F BG S4A0 00 04

UNASSEMBLED

Dimensions mm 2507x705x855 h

■ 04



Order no.

F BG M4B0 00 04

ASSEMBLED

F BG S4B0 00 04

UNASSEMBLED

Dimensions mm 2507x705x855 h

■ 04



Order no.

F BG M4C0 00 04

ASSEMBLED

F BG S4C0 00 04

UNASSEMBLED

Dimensions mm 2507x705x855 h

■ 04



Order no.

F BG M4AA 00 04

ASSEMBLED

F BG S4AA 00 04

UNASSEMBLED

Dimensions mm 2507x705x855 h

■ 04

STEEL WORKSTATIONS 2500

WITH STEEL WORKTOP



Order no.

F BG M4AB 00 04

ASSEMBLED

F BG S4AB 00 04

UNASSEMBLED

Dimensions mm 2507x705x855 h

■ 04



Order no.

F BG M4AC 00 04

ASSEMBLED

F BG S4AC 00 04

UNASSEMBLED

Dimensions mm 2507x705x855 h

■ 04



Order no.

F BG M4BB 00 04

ASSEMBLED

F BG S4BB 00 04

UNASSEMBLED

Dimensions mm 2507x705x855 h

■ 04



Order no.

F BG M4BC 00 04

ASSEMBLED

F BG S4BC 00 04

UNASSEMBLED

Dimensions mm 2507x705x855 h

■ 04





Order no.

F BG M4CC 00 04

ASSEMBLED

F BG S4CC 00 04

UNASSEMBLED

Dimensions mm 2507x705x855 h

■ 04



Order no.

F BG M4BC CB 04

ASSEMBLED

F BG S4BC CB 04

UNASSEMBLED

Dimensions mm 2507x705x855 h

■ 04



Order no.

F BG M4CB 01 04

ASSEMBLED

F BG S4CB 01 04

UNASSEMBLED

Dimensions mm 2507x705x855 h

■ 04



Detail of
Multibox

Order no.

F BG M4CB 52 04

ASSEMBLED

F BG S4CB 52 04

UNASSEMBLED

Dimensions mm 2507x705x855 h

Complete with 32 Multibox with each 1 partition

■ 04

WORKSTATIONS WITH WOODEN WORKTOP



STEEL WORKSTATIONS 1000

WITH WOODEN WORKTOP

STANDARD
COLOUR
BLUE 04

■ RAL 5012

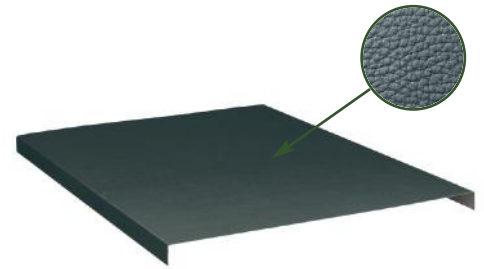

STEEL COVER WITH RUBBER COATING

Order no.

F BL 2430 00 07

Dimensions mm 1024x755x30 h

COLOUR BLACK



WORKSTATIONS

LOAD CAPACITY:

1000 KG



Order no.

F BG M500 00 04 ASSEMBLED

F BG S500 00 04 UNASSEMBLED

Dimensions mm 1024x750x880 h

■ 04



Order no.

F BG M500 01 04 ASSEMBLED

F BG S500 01 04 UNASSEMBLED

Dimensions mm 1024x750x880 h

■ 04



Detail of
Multibox

Order no.

F BG M500 52 04 ASSEMBLED

F BG S500 52 04 UNASSEMBLED

Dimensions mm 1024x750x880 h

■ 04 Complete with 10 Multibox with each 1 partition and 2 containers



Order no.

F BG M5A0 00 04 ASSEMBLED

F BG S5A0 00 04 UNASSEMBLED

Dimensions mm 1024x750x880 h

■ 04



Order no.

F BG M5B0 00 04 ASSEMBLED

F BG S5B0 00 04 UNASSEMBLED

Dimensions mm 1024x750x880 h

■ 04



Order no.

F BG M5C0 00 04 ASSEMBLED

F BG S5C0 00 04 UNASSEMBLED

Dimensions mm 1024x750x880 h

■ 04

STEEL WORKSTATIONS 1500

WITH WOODEN WORKTOP



ORD. NO. Workstation **F BG M600 S1 04**
Complete with Multibox and steel cover with rubber coating. Dimensions mm 1500x750x880 h.

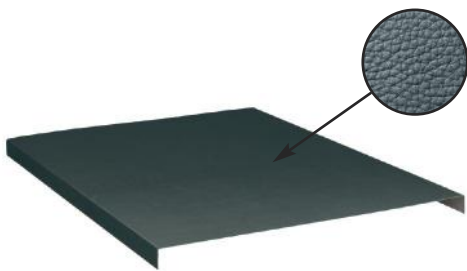

STEEL COVER WITH RUBBER COATING

Order no.
F BL 2460 00 07
Dimensions mm 1500x755x30
COLOUR BLACK



WORKSTATIONS
LOAD CAPACITY:
1000 KG



Order no.
F BG M600 00 04 ASSEMBLED
F BG S600 00 04 UNASSEMBLED
Dimensions mm 1500x750x880 h

■ 04



Order no.
F BG M6A0 00 04 ASSEMBLED
F BG S6A0 00 04 UNASSEMBLED
Dimensions mm 1500x750x880 h

■ 04



Order no.
F BG M6C0 00 04 ASSEMBLED
F BG S6C0 00 04 UNASSEMBLED
Dimensions mm 1500x750x880 h

■ 04



STEEL WORKSTATIONS 1500

WITH WOODEN WORKTOP

STANDARD
COLOUR
BLUE 04

■ RAL 5012

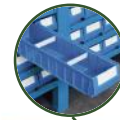

Detail of
Multibox



Order no.
F BG M6B0 00 04 ASSEMBLED
F BG S6B0 00 04 UNASSEMBLED
Dimensions mm 1500x750x880 h
■ 04



Order no.
F BG M6B0 01 04 ASSEMBLED
F BG S6B0 01 04 UNASSEMBLED
Dimensions mm 1500x750x880 h
■ 04



Order no.
F BG M6B0 52 04 ASSEMBLED
F BG S6B0 52 04 UNASSEMBLED
Dimensions mm 1500x750x880 h
■ 04 Complete with 10 Multibox with each 1 partition and 2 containers



Order no.
F BG M6AA 00 04 ASSEMBLED
F BG S6AA 00 04 UNASSEMBLED
Dimensions mm 1500x750x880 h
■ 04



Order no.
F BG M6AB 00 04 ASSEMBLED
F BG S6AB 00 04 UNASSEMBLED
Dimensions mm 1500x750x880 h
■ 04



Order no.
F BG M6AC 00 04 ASSEMBLED
F BG S6AC 00 04 UNASSEMBLED
Dimensions mm 1500x750x880 h
■ 04



Order no.
F BG M6BB 00 04 ASSEMBLED
F BG S6BB 00 04 UNASSEMBLED
Dimensions mm 1500x750x880 h
■ 04



Order no.
F BG M6BC 00 04 ASSEMBLED
F BG S6BC 00 04 UNASSEMBLED
Dimensions mm 1500x750x880 h
■ 04



Order no.
F BG M6CC 00 04 ASSEMBLED
F BG S6CC 00 04 UNASSEMBLED
Dimensions mm 1500x750x880 h
■ 04

STEEL WORKSTATIONS 2000

WITH WOODEN WORKTOP



ORD. NO. Workstation **F BG M700 S1 04**
Complete with steel cover with rubber coating.
Dimensions mm 2000x750x880 h.

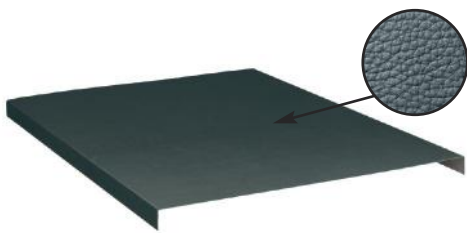

STEEL COVER WITH RUBBER COATING

Order no.
F BL 2490 00 07
Dimensions mm 2000x755x30 h
COLOUR BLACK



**WORKSTATIONS
LOAD CAPACITY:
1000 KG**



Order no.
F BG M700 00 04 ASSEMBLED
F BG S700 00 04 UNASSEMBLED
Dimensions mm 2000x750x880 h

■ 04



Order no.
F BG M700 01 04 ASSEMBLED
F BG S700 01 04 UNASSEMBLED
Dimensions mm 2000x750x880 h

■ 04

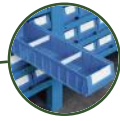

Detail of
Multibox

Order no.

F BG M700 52 04

ASSEMBLED

F BG S700 52 04

UNASSEMBLED

Dimensions mm 2000x750x880 h

Complete with 22 Multibox with each 1 partition and 5 containers

■ 04



Order no.

F BG M7A0 00 04

ASSEMBLED

F BG S7A0 00 04

UNASSEMBLED

Dimensions mm 2000x750x880 h

■ 04



Order no.

F BG M7B0 00 04

ASSEMBLED

F BG S7B0 00 04

UNASSEMBLED

Dimensions mm 2000x750x880 h

■ 04



Order no.

F BG M7B0 01 04

ASSEMBLED

F BG S7B0 01 04

UNASSEMBLED

Dimensions mm 2000x750x880 h

■ 04

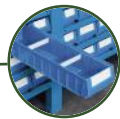

Detail of
Multibox

Order no.

F BG M7B0 52 04

ASSEMBLED

F BG S7B0 52 04

UNASSEMBLED

Dimensions mm 2000x750x880 h

Complete with 16 Multibox with each 1 partition and 4 containers

■ 04



Order no.

F BG M7C0 00 04

ASSEMBLED

F BG S7C0 00 04

UNASSEMBLED

Dimensions mm 2000x750x880 h

■ 04

STEEL WORKSTATIONS 2000

WITH WOODEN WORKTOP



Order no.
F BG M7AA 00 04 ASSEMBLED
F BG S7AA 00 04 UNASSEMBLED
 Dimensions mm 2000x750x880 h
 ■ 04



Order no.
F BG M7AA 01 04 ASSEMBLED
F BG S7AA 01 04 UNASSEMBLED
 Dimensions mm 2000x750x880 h
 ■ 04



Detail of Multibox

Order no.
F BG M7AA 52 04 ASSEMBLED
F BG S7AA 52 04 UNASSEMBLED
 Dimensions mm 2000x750x880 h
 Complete with 16 Multibox with each 1 partition and 5 containers
 ■ 04



Order no.
F BG M7AB 00 04 ASSEMBLED
F BG S7AB 00 04 UNASSEMBLED
 Dimensions mm 2000x750x880 h
 ■ 04



Order no.
F BG M7AC 00 04 ASSEMBLED
F BG S7AC 00 04 UNASSEMBLED
 Dimensions mm 2000x750x880 h
 ■ 04



Order no.
F BG M7BB 00 04 ASSEMBLED
F BG S7BB 00 04 UNASSEMBLED
 Dimensions mm 2000x750x880 h
 ■ 04





Order no.

F BG M7BC 00 04

ASSEMBLED

F BG S7BC 00 04

UNASSEMBLED

Dimensions mm 2000x750x880 h

■ 04



Order no.

F BG M7BC 01 04

ASSEMBLED

F BG S7BC 01 04

UNASSEMBLED

Dimensions mm 2000x750x880 h

■ 04



Detail of
Multibox

Order no.

F BG M7BC 52 04

ASSEMBLED

F BG S7BC 52 04

UNASSEMBLED

Dimensions mm 2000x750x880 h

Complete with 20 Multibox with each 1 partition

■ 04



Order no.

F BG M7CC 00 04

ASSEMBLED

F BG S7CC 00 04

UNASSEMBLED

Dimensions mm 2000x750x880 h

■ 04



Order no.

F BG M7AA A0 04

ASSEMBLED

F BG S7AA A0 04

UNASSEMBLED

Dimensions mm 2000x750x880 h

■ 04



Order no.

F BG M7AB A0 04

ASSEMBLED

F BG S7AB A0 04

UNASSEMBLED

Dimensions mm 2000x750x880 h

■ 04

STEEL WORKSTATIONS 2500

WITH WOODEN WORKTOP



ORD. NO. Workstation F BG M800 S1 04
Complete with 3 storage containers, multi-purpose panel and steel cover with rubber coating.
Dimensions mm 2500x750x880 h.

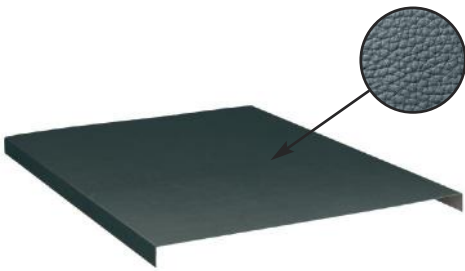

STEEL COVER WITH RUBBER COATING

Order no.
F BL 2505 00 07
Dimensions mm 2500x755x30 h
COLOUR BLACK



WORKSTATIONS
LOAD CAPACITY:
1000 KG



Order no.
F BG M800 00 04 ASSEMBLED
F BG S800 00 04 UNASSEMBLED
Dimensions mm 2500x750x880 h

■ 04





Order no.

F BG M8A0 00 04

ASSEMBLED

F BG S8A0 00 04

UNASSEMBLED

Dimensions mm 2500x750x880 h

■ 04



Order no.

F BG M8B0 00 04

ASSEMBLED

F BG S8B0 00 04

UNASSEMBLED

Dimensions mm 2500x750x880 h

■ 04



Order no.

F BG M8C0 00 04

ASSEMBLED

F BG S8C0 00 04

UNASSEMBLED

Dimensions mm 2500x750x880 h

■ 04



Order no.

F BG M8AA 00 04

ASSEMBLED

F BG S8AA 00 04

UNASSEMBLED

Dimensions mm 2500x750x880 h

■ 04

STEEL WORKSTATIONS 2500

WITH WOODEN WORKTOP



Order no.

F BG M8AB 00 04

ASSEMBLED

F BG S8AB 00 04

UNASSEMBLED

Dimensions mm 2500x750x880 h

■ 04



Order no.

F BG M8AC 00 04

ASSEMBLED

F BG S8AC 00 04

UNASSEMBLED

Dimensions mm 2500x750x880 h

■ 04



Order no.

F BG M8BB 00 04

ASSEMBLED

F BG S8BB 00 04

UNASSEMBLED

Dimensions mm 2500x750x880 h

■ 04



Order no.

F BG M8BC 00 04

ASSEMBLED

F BG S8BC 00 04

UNASSEMBLED

Dimensions mm 2500x750x880 h

■ 04



STEEL WORKSTATIONS 2500

WITH WOODEN WORKTOP

STANDARD
COLOUR
BLUE 04
■ RAL 5012



Order no.
F BG M8CC 00 04 ASSEMBLED
F BG S8CC 00 04 UNASSEMBLED
Dimensions mm 2500x750x880 h
 ■ 04



Order no.
F BG M8BC CB 04 ASSEMBLED
F BG S8BC CB 04 UNASSEMBLED
Dimensions mm 2500x750x880 h
 ■ 04



Order no.
F BG M8CB 01 04 ASSEMBLED
F BG S8CB 01 04 UNASSEMBLED
Dimensions mm 2500x750x880 h
 ■ 04

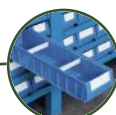

Detail of
Multibox

Order no.
F BG M8CB 52 04 ASSEMBLED
F BG S8CB 52 04 UNASSEMBLED
Dimensions mm 2500x750x880 h
 Complete with 32 Multibox with each 1 partition
 ■ 04

PERFORATED PANELS WITH WALL FIXING SET

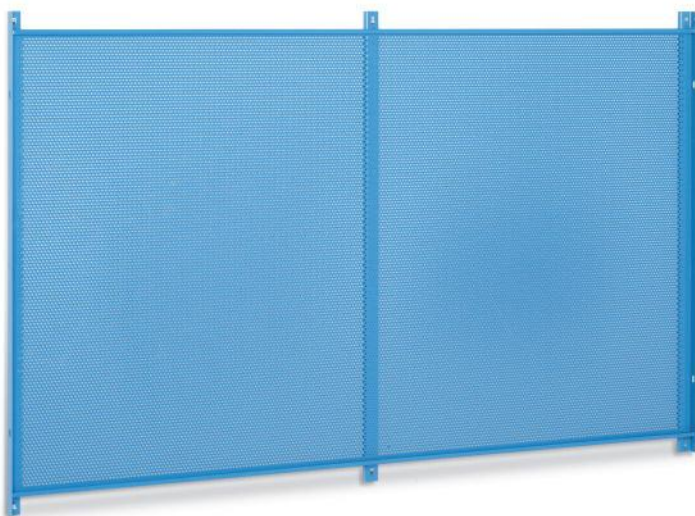

Order no.	Dimensions mm
F BG 3915 00 04	1500x850 h
F BG 3920 00 04	2000x850 h

Hole diameter 4 mm. FIXING SET EXCLUDED.

■ 04



Example of how to use the perforated panel with wall fixing

SHELF FOR PERFORATED PANELS

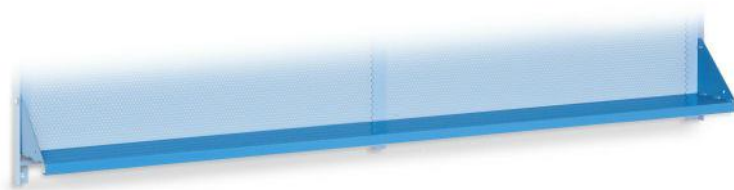

Order no.	Dimensions mm
F BG 3945 00 04	1500x140 h
F BG 3950 00 04	2000x140 h

■ 04



Example of how to use the shelf for perforated panel

HOOKS FOR PERFORATED PANELS

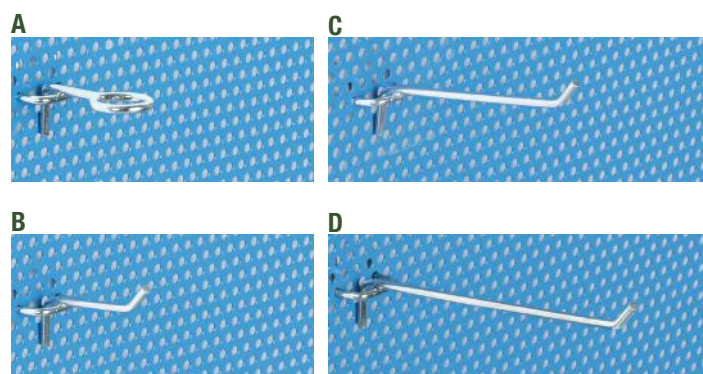

Order no.	Reference	Package
F BG 3970 01 99	A	10 pcs
F BG 3971 01 99	B	10 pcs
F BG 3972 01 99	C	10 pcs
F BG 3973 01 99	D	10 pcs

■ 99 galvanised



Example of how to use the hooks for perforated panel

SUPPORT COLUMNS WITH BOTH SIDE DUAL SLOTS FOR STEEL WORKTOPS

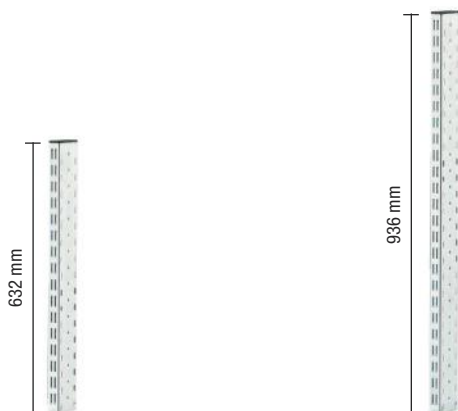

Order no.
F BL 7530 03 99
 Support column with both side dual slots height 634 mm for 2 panels.
 Load capacity: 50 kg.

■ 01 ■ 02 ■ 04 ■ 08 ■ 99

Order no.
F BL 7535 03 99
 Support column with both side dual slots height 938 mm for 3 panels.
 Load capacity: 50 kg.

■ 01 ■ 02 ■ 04 ■ 08 ■ 99

SUPPORT COLUMNS WITH BOTH SIDE DUAL SLOTS FOR WOODEN WORKTOPS

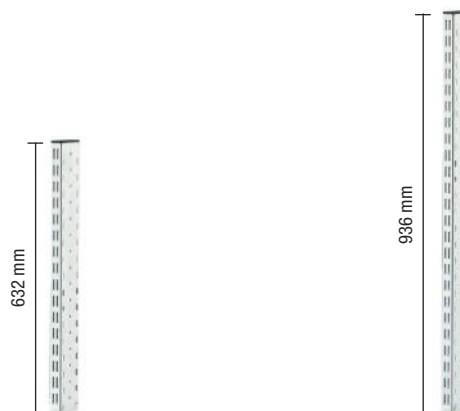

Order no.
F BL 7530 00 99
 Support column with both side dual slots height 634 mm for 2 panels.
 Load capacity: 50 kg.

■ 01 ■ 02 ■ 04 ■ 08 ■ 99

Order no.
F BL 7535 00 99
 Support column with both side dual slots height 938 mm for 3 panels.
 Load capacity: 50 kg.

■ 01 ■ 02 ■ 04 ■ 08 ■ 99

ROLLER SHUTTER CABINET



Order no.	Fixing type	Cylinder lock	Load capacity kg
F BL 7011 01 51	to the wall	series 45	50
F BL 7011 03 51	to the wooden worktop	series 45	50

Overall dimensions mm 952x210x810 h

Usable dimensions mm 905x150x581 h

HOOKS AND TOOLS EXCLUDED

■ 01 ■ 02 ■ 51 ■ 56



Order no.	Fixing type	Cylinder lock	Load capacity kg
F BL 7021 01 51	to the wall	series 45	50
F BL 7021 03 51	to the wooden worktop	series 45	50

Overall dimensions mm 952x210x1115 h

Usable dimensions mm 905x150x885 h

HOOKS AND TOOLS EXCLUDED

■ 01 ■ 02 ■ 51 ■ 56

ANGLE HOOK



Order no.	Ø	L	B
C MV 10 016	5	50	40

SPRING CLIP

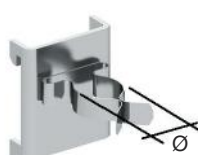

Order no.	Ø
C MV 10 020	7
C MV 10 021	11
C MV 10 022	15
C MV 10 023	18

SUSPENSION HOOK

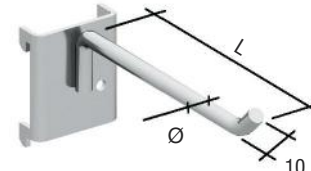

Order no.	Ø	L
C MV 10 037	5	24
C MV 10 038	5	38
C MV 10 039	4	100
C MV 10 040	6	100
C MV 10 041	5	150
C MV 10 042	6	200

SHELF FOR MULTI-PURPOSE PANELS LENGHT 1000 mm

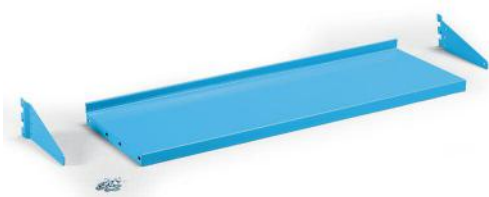

Order no.	Depth of shelf mm	Load capacity kg
F BL 7750 00 04	220	25
F BL 7755 00 04	320	25
F BL 7760 00 04	420	25
F BL 7762 00 04	600	25

■ 01 ■ 02 ■ 04 ■ 08 ■ 99

Height-adjustable tilting shelf in 2 positions with front or rear upstand

AVAILABLE IN 4 DIMENSIONS:

955x220 mm 955x320 mm 955x420 mm 955x600 mm

SHELF FOR MULTI-PURPOSE PANELS LENGHT 1500 mm

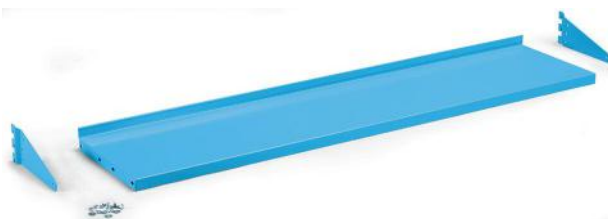

Order no.	Depth of shelf mm	Load capacity kg
F BL 7795 00 04	220	25
F BL 7800 00 04	320	25
F BL 7805 00 04	420	25

■ 01 ■ 02 ■ 04 ■ 08 ■ 99

Height-adjustable tilting shelf in 2 positions with front or rear upstand

AVAILABLE IN 3 DIMENSIONS:

1440x220 mm 1440x320 mm 1440x420 mm

PERFORATED PANEL

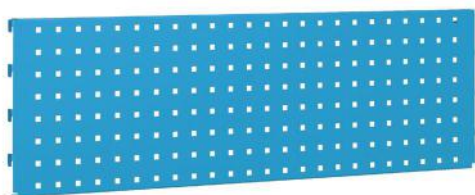

Order no.	Length of panel mm	Load capacity kg
F BL 7620 00 04	973	25
F BL 7635 00 04	1458	25

■ 01 ■ 02 ■ 04 ■ 08

Perforated panel equipped for fixing the support columns with both side dual slots

AVAILABLE IN 2 DIMENSIONS:

973x304 mm h for length 1000 mm
1458x304 mm h for length 1500 mm

PLAIN PANEL

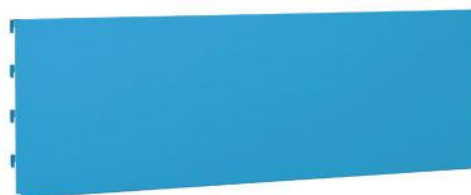

Order no.	Length of panel mm
F BL 7670 00 04	973
F BL 7675 00 04	1458

■ 01 ■ 02 ■ 04 ■ 08

Plain panel equipped for fixing the support columns with both side dual slots

AVAILABLE IN 2 DIMENSIONS:

973x304 mm h for length 1000 mm
1458x304 mm h for length 1500 mm

STEEL VICES 110 MM



Order no.	Suitable for
F BL 1015 00 00	Wooden worktop
F BL 1015 01 00	Steel worktop

Steel vices 110 mm with front opening.

A = 120 mm B = 385 mm C = 110 mm
D = 113 mm E = knurled G = 7 kg

STEEL VICES 130 MM



Order no.	Suitable for
F BL 1020 00 00	Wooden worktop
F BL 1020 01 00	Steel worktop

Steel vices 130 mm with front opening.

A = 140 mm B = 430 mm C = 130 mm
D = 137 mm E = knurled G = 11 kg

A = maximum jaw opening

B = maximum width of vice

C = width of jaws

D = height of vice

E = knurled jaws

G = weight of vice

MULTIBOX



Order no. **F PK 4551 00 04** **Dim. mm** **600x160x100 h**
 Max. q.ty of transversal dividers which can be inserted:
 10 pcs. ORD. NO. F PK 7368 00 96
 ■ 04

TRANSVERSAL DIVIDERS



Order no. **F PK 7368 00 96** **Dim. mm** **145x90 h**
 For boxes ORD. NO. F PK 4551 00 04
 ■ 96 transparent

SAFETY GUARDS FOR MULTIBOX BOXES



Order no. **F PK 9465 00 99** **Ø mm** **4,2**
 For boxes ORD. NO. F PK 4551 00 04
 ■ 99 galvanised



Assembling the safety guards for multibox boxes

MULTIBOX



Order no. **F PK 3051 00 04** **Dim. mm** **500x120x100 h**
 Max. q.ty of transversal dividers which can be inserted:
 8 pcs. ORD. NO. F PK 7068 00 96
 ■ 04

TRANSVERSAL DIVIDERS



Order no. **F PK 7068 00 96** **Dim. mm** **100x90 h**
 For boxes ORD. NO. F PK 3051 00 04
 ■ 96 transparent

SAFETY GUARDS FOR MULTIBOX BOXES



Order no. **F PK 9460 00 99** **Ø mm** **4,2**
 Per cassette ART. F PK 3051 00 04
 ■ 99 galvanised

REAR STOP



Order no. **F PK 9440 00 99**
 For boxes ORD. NO. F PK 3051 00 04
 ■ 99 galvanised

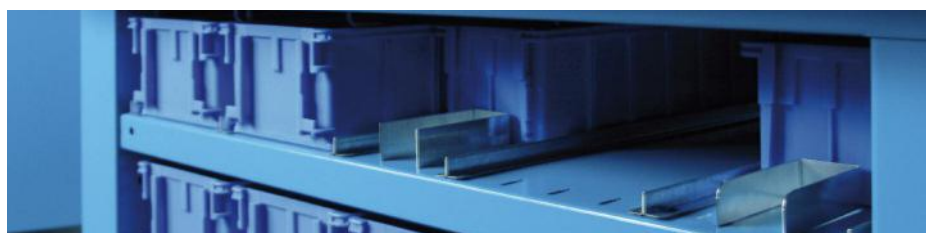

Assembling the rear stop

LABELS FOR BOXES



Order no. **F PK 9580 00 00** **Dim. mm** **121x44**
 For boxes ORD. NO. F PK 4551 00 04. Label per sheet: 8

Order no. **F PK 9540 00 00** **Dim. mm** **81x42**
 For boxes ORD. NO. F PK 3051 00 04. Label per sheet: 12

LABELS FOR DIVIDERS



Order no. **F PK 9560 00 00** **Dim. mm** **121x24 h**
 For dividers ORD. NO. F PK 7368 00 96.
 Label per sheet: 16

Order no. **F PK 9520 00 00** **Dim. mm** **80x24**
 For dividers ORD. NO. F PK 7068 00 96
 Label per sheet: 24

GUIDE RAILS FOR MULTIBOX



Order no. **F ST 9860 00 99**
 ■ 99 galvanised

CONTAINERS SERIES COMPAT



Order no. **F PM 6551 00 01** **Dim. mm** **500/450x300x200 h**
 Internal dim. mm: 435x281x186 h.
 Capacity litres: 28. Weight gr.: 1355
 ■ 01 ■ 02 ■ 03 ■ 04 ■ 05

UPPER AND LOWER SHELVES, LEGS, BARS

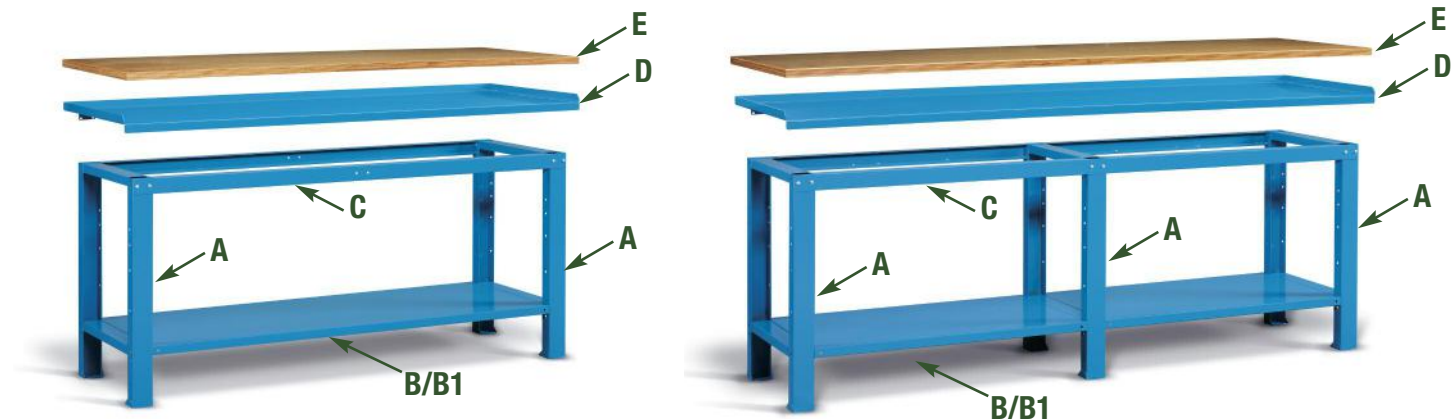

Order no.	Width workstation	Reference	Description	Dimensions mm	Load capacity kg
F BG 3000 00 04	-	A	Leg	80x610x852 h	-
F BG 3308 00 04	1031/1024 mm	B	Not slotted steel shelf	760x600x35 h	250
F BG 3408 00 04		B1	Slotted steel shelf	760x600x35 h	60
F BG 3510 01 04		C	Pair of upper bars	915x60x48 h	-
F BG 3110 00 04		D	Steel worktop	1031x705x32 h	1000
F BI A014 02 04		E	Multiplex worktop	1024x750x30 h	1000
F BG 3313 00 04	1507/1500 mm	B	Not slotted steel shelf	1260x600x35 h	250
F BG 3413 00 04		B1	Slotted steel shelf	1260x600x35 h	60
F BG 3515 01 04		C	Pair of upper bars	1415x60x48 h	-
F BG 3115 00 04		D	Steel worktop	1507x705x32 h	1000
F BI A042 02 04		E	Multiplex worktop	1500x750x30 h	1000
F BG 3318 00 04	2007/2000 mm	B	Not slotted steel shelf	1760x600x35 h	200
F BG 3418 00 04		B1	Slotted steel shelf	1760x600x35 h	60
F BG 3520 01 04		C	Pair of upper bars	1915x60x48 h	-
F BG 3120 00 04		D	Steel worktop	2000x705x32 h	1000
F BI A070 02 04		E	Multiplex worktop	2000x750x30 h	1000
F BG 3311 00 04	2507/2500 mm	B	Not slotted single steel shelf (per unit)	1090x600x35 h	250
F BG 3411 00 04		B1	Slotted single steel shelf (per unit)	1090x600x35 h	60
F BG 3525 01 04		C	Pair of upper bars full length	2415x60x48 h	-
F BG 3125 00 04		D	Steel worktop	2507x705x32 h	1000
F BI A084 02 04		E	Multiplex worktop	2500x750x30 h	1000

■ 04 ■ MULTIPLEX

DRAWER CABINETS FOR STEEL WORKSTATIONS



Order no.
F BG 3030 01 04
Dimensions mm 500x607x570 h.
Drawer load capacity 25 kg.

■ 04

Order no.
F BG 3050 01 04
Dimensions mm 500x607x570 h.
Drawer load capacity 25 kg.

■ 04

Order no.
F BG 3010 01 04
Dimensions mm 500x607x210 h.
Drawer load capacity 25 kg.

■ 04

BACK AND SIDE PANELS

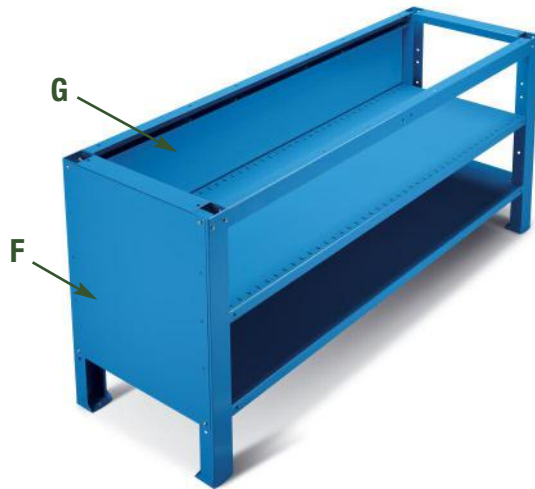

PREASSEMBLED



Order no. preassembled
F BG 3999 00 00

The preassembling will be charged
to all single components

Order no.	Width workstation mm	Reference	Description	Dimensions mm
F BG 3690 00 04	-	F	Side panel	590x660 h
F BG 3608 00 04	1031/1024	G	Back panel	840x48x653 h
F BG 3613 00 04	1507/1500	G	Back panel	1340x48x653 h
F BG 3618 00 04	2007/2000	G	Back panel	1840x48x653 h
F BG 3611 00 04	2507/2500	G	Single back panel per unit	1170x48x653 h

04

NOT SLOTTED AND SLOTTED STEEL SHELVES

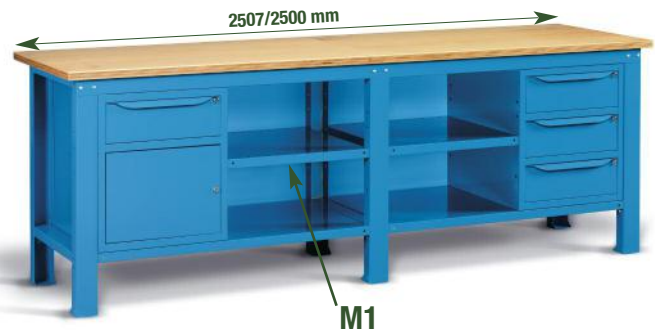
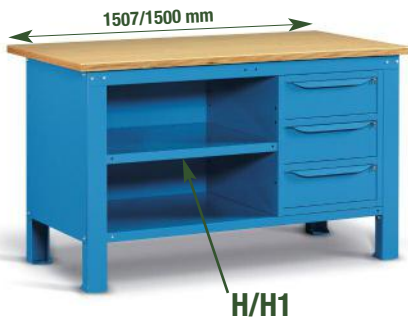

Order no.	Reference	Description	Dimensions mm	Load capacity kg
F BG 3308 00 04	H	Not slotted steel shelf	760x600x35 h	250
F BG 3408 00 04	H1	Slotted steel shelf	760x600x35 h	60
F BG 3313 00 04	L	Not slotted steel shelf	1260x600x35 h	250
F BG 3413 00 04	L1	Slotted steel shelf	1260x600x35 h	60
F BG 3406 00 04	M1	Slotted steel shelf	590x600x35 h	60

04

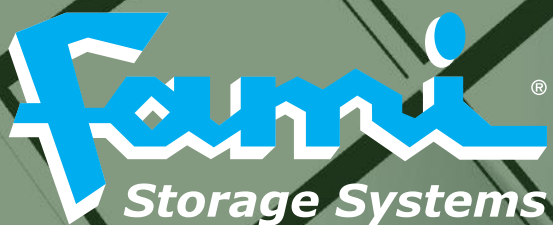

FAMI S.r.l.
Via stazione rossano, 13 - 36027 Rosà (VI)
T. +39 0424 585455 r.a. - F. +39 0424 585472
www.famispa.com - export@famispa.com

ORGANIZE SPACE

LET'S REORG



■ **WORKSTATIONS SERIES WORK**

SEVERAL WORKTOPS TYPES AVAILABLE

STANDARDISED ELECTRIC AND PNEUMATIC SYSTEM

VERSATILE

SEVERAL ACCESSORIES SERIES



ORGANIZE SPACE LET'S REORG

SERIES WORK

WOODEN WORKTOPS

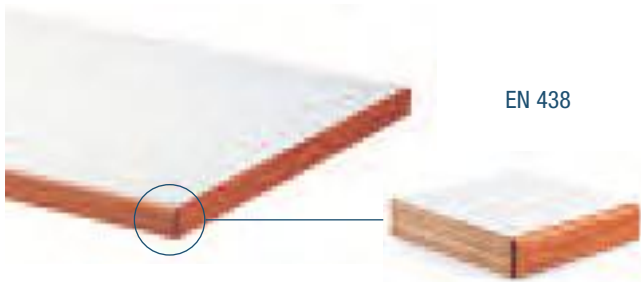

EN 438

MULTIPLEX WORKTOP COVERED WITH GREY LAMINATE WITH SOLID WOOD EDGING
This is a multiplex worktop to which a sheet of light grey matt laminate has been glued. The edges are finished in a solid beech wood.



EN 438

MULTIPLEX WORKTOP COVERED WITH GREY LAMINATE WITH LAMINATE EDGING
This is a multiplex worktop to which a sheet of light grey matt laminate has been glued. The edges are also finished with the same laminate.

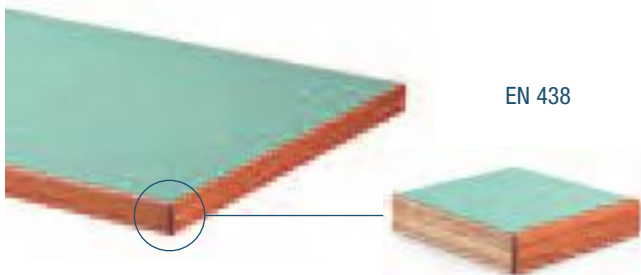

EN 438

MULTIPLEX WORKTOP COVERED WITH GREEN LAMINATE WITH SOLID WOOD EDGING
This is a multiplex worktop to which a sheet of light green matt laminate has been glued. The edges are finished in a solid beech wood.

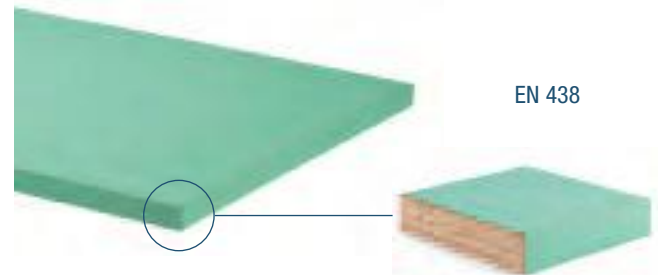

EN 438

MULTIPLEX WORKTOP COVERED WITH GREEN LAMINATE WITH LAMINATE EDGING
This is a multiplex worktop to which a sheet of light green matt laminate has been glued. The edges are also finished with the same laminate.

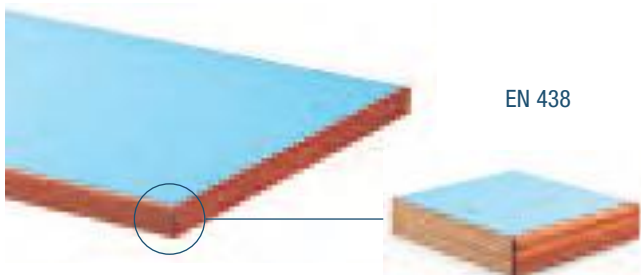

EN 438

MULTIPLEX WORKTOP COVERED WITH BLUE LAMINATE WITH SOLID WOOD EDGING
This is a multiplex worktop to which a sheet of light blue matt laminate has been glued. The edges are finished in a solid beech wood.

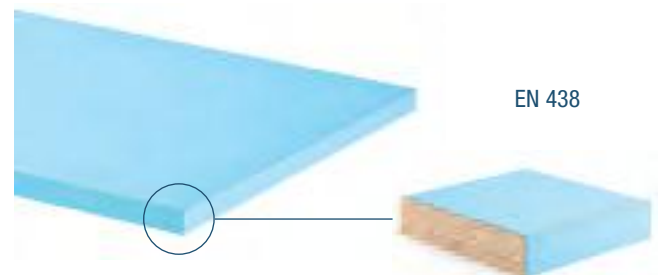

EN 438

MULTIPLEX WORKTOP COVERED WITH BLUE LAMINATE WITH LAMINATE EDGING
This is a multiplex worktop to which a sheet of light blue matt laminate has been glued. The edges are also finished with the same laminate.

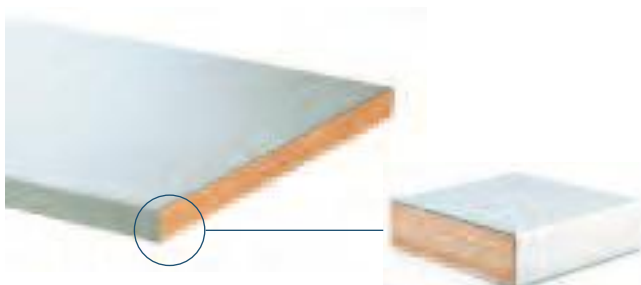

MULTIPLEX WORKTOP WITH GALVANISED STEEL COVER

This includes a multiplex worktop covered with a 2 mm thickness galvanised layer of sheet steel. This type of covering makes the worktop abrasion, oil and grease resistant.

For other types of worktops see catalogue **no. 300 Workstations**

MULTIPLEX WORKTOP

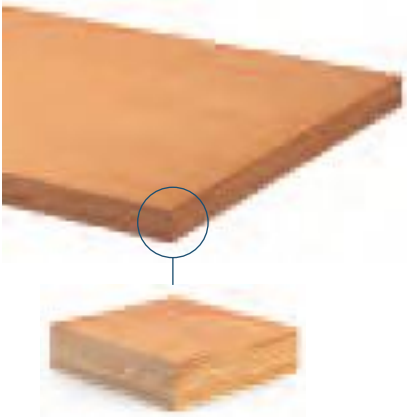

The multiplex worktop includes various layers of beech wood which are planed, glued and pressed together. This makes the worktop non-deformable and load and wear resistant.

WORKTOP DIMENSION mm	ORD. NO. 30 mm THICKNESS	ORD. NO. 40 mm THICKNESS	ORD. NO. 50 mm THICKNESS
1024x750	-	F BI A214 00 00	-
1024x800	-	-	F BI A514 00 00
1300x750	-	F BI A228 00 00	F BI A428 00 00
1300x800	-	F BI A328 00 00	F BI A528 00 00
1500x750	-	F BI A242 00 00	F BI A442 00 00
1500x800	*F BI A142 00 00	F BI A342 00 00	F BI A542 00 00
2000x750	-	F BI A270 00 00	F BI A470 00 00
2000x800	*F BI A170 00 00	F BI A370 00 00	F BI A570 00 00
2500x750	-	F BI A284 00 00	F BI A484 00 00
2500x800	-	F BI A384 00 00	F BI A584 00 00
3000x750	-	**F BI A298 00 00	*F BI A498 00 00
3000x800	-	**F BI A398 00 00	*F BI A598 00 00

**For modular workbenches only

*For mobile workbenches series F CA - F CC

WORKTOP WITH 3 CROSS-GLUED LAYERS

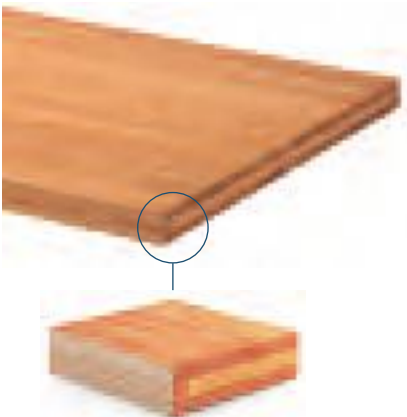

This is made from three cross-glued layers of beech wood in order to form a smooth surface which is then treated with an antiseptic material. The three layers are joined together by a toothed milling process which offers a larger connection surface.

WORKTOP DIMENSION mm	ORD. NO. 30 mm THICKNESS	ORD. NO. 40 mm THICKNESS	ORD. NO. 50 mm THICKNESS
1024x750	-	-	-
1024x800	-	-	-
1300x750	-	-	F BK A428 00 00
1300x800	-	-	F BK A528 00 00
1500x750	-	-	F BK A442 00 00
1500x800	-	-	F BK A542 00 00
2000x750	-	-	F BK A470 00 00
2000x800	-	-	F BK A570 00 00
2500x750	-	-	F BK A484 00 00
2500x800	-	-	F BK A584 00 00
3000x750	-	-	F BK A498 00 00
3000x800	-	-	F BK A598 00 00

STEEL COVER WITH OIL PROOF RUBBER COATING



This rubber is between 1.2 and 1.5 mm thickness. The rubber-coated electrogalvanised steel sheet featuring a L-shaped profile at the two long sides, can also be supplied separately. It is easy to be fitted as no screws are required.

WORKTOP DIMENSION mm	ORD. NO. 33 mm THICKNESS	ORD. NO. 43 mm THICKNESS	ORD. NO. 53 mm THICKNESS
1024x750	-	F BL 2630 00 07	-
1024x800	-	-	F BL 2835 00 07
1300x750	-	F BL 2645 00 07	F BL 2845 00 07
1300x800	-	F BL 2650 00 07	F BL 2850 00 07
1500x750	-	F BL 2660 00 07	F BL 2860 00 07
1500x800	F BL 2465 00 07	F BL 2665 00 07	F BL 2865 00 07
2000x750	-	F BL 2690 00 07	F BL 2890 00 07
2000x800	F BL 2495 00 07	F BL 2695 00 07	F BL 2895 00 07
2500x750	-	F BL 2705 00 07	F BL 2905 00 07
2500x800	-	F BL 2710 00 07	F BL 2910 00 07
3000x750	-	F BL 2720 00 07	F BL 2920 00 07
3000x800	-	F BL 2725 00 07	F BL 2925 00 07

SERIES WORK 13

LENGTH = 1300 mm DEPTH = 800 mm (27x36 Eh)



ORD. NO. F BH A328 S1 04
RAL 5012

**WORKSTATION****ORD. NO.****F BH A328 S1 04**

Dimensions mm 1300x800x840/1472 h

Tools and drawer partitioning sets excluded

All the workbenches series WORK components are supplied without pre-drilling and bolts. To fix the components to the workbenches series WORK it is necessary to order the following **FIXING MATERIAL**:

**ORD. NO. F BL 9021 00 00**

For bench leg, adjustable bench leg, bench leg with wheels, cabinet with steel vice, bench leg for power fittings

ORD. NO. F BL 9011 00 00

Cabinets with shelves or doors

RAL 7000 F.01

RAL 6011 F.02

RAL 5012 F.04

RAL 7035 F.08

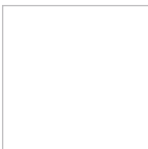
SUPPLEMENTARY PARTS ■

■ **Spare key.** Always indicate the number on the cylinder lock of the key to be replaced.

ORD. NO. R CSC 0002 00

■ **Master key.** This type of key opens all the 45 and 46 series locks.

ORD. NO. R CSC 0001 00



LENGTH = 1300 mm DEPTH = 800 mm (27x36 Eh)

SERIES WORK 13-80

SHELVES 800 mm DEEP

ORD. NO.	TYPE OF WORKTOP	THICKNESS mm	LOAD CAP. kg
F BI A528 01 04	Multiplex	50	1500
F BI A328 01 04	Multiplex	40	1200
F BK A528 01 04	3 cross-glued layers	50	1500
F BH A328 01 04	Grey laminate with solid wood	40	1200
F BH B328 01 04	Grey laminate	40	1200

Bottom shelf, ord. no. F BI 1135 00 00, load capacity: 130 kg



ORD. NO.	TYPE OF WORKTOP	THICKNESS mm	LOAD CAP. kg
F BI A528 04 04	Multiplex	50	1500
F BI A328 04 04	Multiplex	40	1200
F BK A528 04 04	3 cross-glued layers	50	1500
F BH A328 04 04	Grey laminate with solid wood	40	1200
F BH B328 04 04	Grey laminate	40	1200

Bottom shelf, ord. no. F BI 1135 00 00, load capacity: 130 kg

ORD. NO.	TYPE OF WORKTOP	THICKNESS mm	LOAD CAP. kg
F BI A528 10 04	Multiplex	50	1500
F BI A328 10 04	Multiplex	40	1200
F BK A528 10 04	3 cross-glued layers	50	1500
F BH A328 10 04	Grey laminate with solid wood	40	1200
F BH B328 10 04	Grey laminate	40	1200

Bottom shelf, ord. no. F BI 1135 00 00, load capacity: 130 kg



ORD. NO.	TYPE OF WORKTOP	THICKNESS mm	LOAD CAP. kg
F BI A528 13 04	Multiplex	50	1500
F BI A328 13 04	Multiplex	40	1500
F BK A528 13 04	3 cross-glued layers	50	1500
F BH A328 13 04	Grey laminate with solid wood	40	1500
F BH B328 13 04	Grey laminate	40	1500

Bottom shelf, ord. no. F BI 0575 01 01, load capacity: 180 kg

ORD. NO.	TYPE OF WORKTOP	THICKNESS mm	LOAD CAP. kg
F BI A528 16 04	Multiplex	50	1500
F BI A328 16 04	Multiplex	40	1500
F BK A528 16 04	3 cross-glued layers	50	1500
F BH A328 16 04	Grey laminate with solid wood	40	1500
F BH B328 16 04	Grey laminate	40	1500

Bottom shelf, ord. no. F BI 0575 01 01, load capacity: 180 kg

KEY

RAL 7000 F.01 RAL 6011 F.02 RAL 5012 F.04 RAL 7035 F.08



- PE = Retractable shelf
- All indicated loads are net and refer to evenly distributed weights

■ Sets of partitions see page A72 - A73



SERIES WORK 13-75

LENGTH = 1300 mm DEPTH = 750 mm (27x36 Eh)

SHELVES 750 mm DEEP

ORD. NO.	TYPE OF WORKTOP	THICKNESS mm	LOAD CAP. kg
F BI A428 01 04	Multiplex	50	1500
F BI A228 01 04	Multiplex	40	1200
F BK A428 01 04	3 cross-glued layers	50	1500
F BH A228 01 04	Grey laminate with solid wood	40	1200
F BH B228 01 04	Grey laminate	40	1200

Bottom shelf, ord. no. F BI 1135 00 00, load capacity: 130 kg



ORD. NO.	TYPE OF WORKTOP	THICKNESS mm	LOAD CAP. kg
F BI A428 04 04	Multiplex	50	1500
F BI A228 04 04	Multiplex	40	1200
F BK A428 04 04	3 cross-glued layers	50	1500
F BH A228 04 04	Grey laminate with solid wood	40	1200
F BH B228 04 04	Grey laminate	40	1200

Bottom shelf, ord. no. F BI 1135 00 00, load capacity: 130 kg



ORD. NO.	TYPE OF WORKTOP	THICKNESS mm	LOAD CAP. kg
F BI A428 10 04	Multiplex	50	1500
F BI A228 10 04	Multiplex	40	1200
F BK A428 10 04	3 cross-glued layers	50	1500
F BH A228 10 04	Grey laminate with solid wood	40	1200
F BH B228 10 04	Grey laminate	40	1200

Bottom shelf, ord. no. F BI 1135 00 00, load capacity: 130 kg



ORD. NO.	TYPE OF WORKTOP	THICKNESS mm	LOAD CAP. kg
F BI A428 13 04	Multiplex	50	1500
F BI A228 13 04	Multiplex	40	1500
F BK A428 13 04	3 cross-glued layers	50	1500
F BH A228 13 04	Grey laminate with solid wood	40	1500
F BH B228 13 04	Grey laminate	40	1500

Bottom shelf, ord. no. F BI 0575 01 01, load capacity: 180 kg

ORD. NO.	TYPE OF WORKTOP	THICKNESS mm	LOAD CAP. kg
F BI A428 16 04	Multiplex	50	1500
F BI A228 16 04	Multiplex	40	1500
F BK A428 16 04	3 cross-glued layers	50	1500
F BH A228 16 04	Grey laminate with solid wood	40	1500
F BH B228 16 04	Grey laminate	40	1500

Bottom shelf, ord. no. F BI 0575 01 01, load capacity: 180 kg

RAL 7000 F.01

RAL 6011 F.02

RAL 5012 F.04

RAL 7035 F.08

KEY ■

■ Sets of partitions see page A72 - A73

- PE = Retractable shelf
- All indicated loads are net and refer to evenly distributed weights



LENGTH = 1300 mm DEPTH = 750 mm (27x36 Eh)

SERIES WORK 13



■ RAL 5012

WORKSTATION**ORD. NO.****F BI A528 S1 04****Dimensions mm 1300x800x850/2120 h**

Tools and chair excluded

■ **INFO**

RAL 7000 F.01

RAL 6011 F.02

RAL 5012 F.04

RAL 7035 F.08

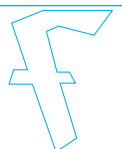

www.famispa.com

SERIES WORK 15

LENGTH = 1500 mm DEPTH = 800 mm (27x36 Eh)

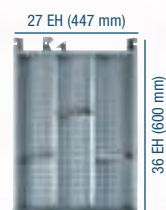

ORD. NO. F BI A542 33 04
RAL 5012

**WORKSTATION****ORD. NO.****F BI A542 33 04**

Dimensions mm 1500x800x890 h

Tools excluded

All the workbenches series WORK components are supplied without pre-drilling and bolts. To fix the components to the workbenches series WORK it is necessary to order the following **FIXING MATERIAL**:

**ORD. NO. F BL 9021 00 00**

For bench leg, adjustable bench leg, bench leg with wheels, cabinet with steel vice, bench leg for power fittings

ORD. NO. F BL 9011 00 00

Cabinets with shelves or doors

RAL 7000 F.01

RAL 6011 F.02

RAL 5012 F.04

RAL 7035 F.08

SUPPLEMENTARY PARTS ■

■ **Spare key.** Always indicate the number on the cylinder lock of the key to be replaced.

ORD. NO. R CSC 0002 00

■ **Master key.** This type of key opens all the 45 and 46 series locks.

ORD. NO. R CSC 0001 00



LENGTH = 1500 mm DEPTH = 800 mm (27x36 Eh)

SERIES WORK 15-80

SHELVES 800 mm DEEP

ORD. NO.	TYPE OF WORKTOP	THICKNESS mm	LOAD CAP. kg
F BI A542 01 04	Multiplex	50	1000
F BI A342 01 04	Multiplex	40	800
F BK A542 01 04	3 cross-glued layers	50	1000
F BH A342 01 04	Grey laminate with solid wood	40	800
F BH B342 01 04	Grey laminate	40	800

Bottom shelf, ord. no. F BI 1340 00 00, load capacity: 130 kg



ORD. NO.	TYPE OF WORKTOP	THICKNESS mm	LOAD CAP. kg
F BI A542 04 04	Multiplex	50	1000
F BI A342 04 04	Multiplex	40	800
F BK A542 04 04	3 cross-glued layers	50	1000
F BH A342 04 04	Grey laminate with solid wood	40	800
F BH B342 04 04	Grey laminate	40	800

Bottom shelf, ord. no. F BI 1340 00 00, load capacity: 130 kg

ORD. NO.	TYPE OF WORKTOP	THICKNESS mm	LOAD CAP. kg
F BI A542 10 04	Multiplex	50	1000
F BI A342 10 04	Multiplex	40	800
F BK A542 10 04	3 cross-glued layers	50	1000
F BH A342 10 04	Grey laminate with solid wood	40	800
F BH B342 10 04	Grey laminate	40	800

Bottom shelf, ord. no. F BI 1340 00 00, load capacity: 130 kg



ORD. NO.	TYPE OF WORKTOP	THICKNESS mm	LOAD CAP. kg
F BI A542 16 04	Multiplex	50	1500
F BI A342 16 04	Multiplex	40	1500
F BK A542 16 04	3 cross-glued layers	50	1500
F BH A342 16 04	Grey laminate with solid wood	40	1500
F BH B342 16 04	Grey laminate	40	1500

Bottom shelf, ord. no. F BI 0773 01 01, load capacity: 180 kg

ORD. NO.	TYPE OF WORKTOP	THICKNESS mm	LOAD CAP. kg
F BI A542 34 04	Multiplex	50	1500
F BI A342 34 04	Multiplex	40	1500
F BK A542 34 04	3 cross-glued layers	50	1500
F BH A342 34 04	Grey laminate with solid wood	40	1500
F BH B342 34 04	Grey laminate	40	1500

Bottom shelf, ord. no. F BI 0773 01 01, load capacity: 180 kg

KEY

- RAL 7000 F.01
- RAL 6011 F.02
- RAL 5012 F.04
- RAL 7035 F.08



- PE = Retractable shelf
- All indicated loads are net and refer to evenly distributed weights

■ Sets of partitions see page A72 - A73



SERIES WORK 15-75

LENGTH = 1500 mm DEPTH = 750 mm (27x36 Eh)

SHELVES 750 mm DEEP

ORD. NO.	TYPE OF WORKTOP	THICKNESS mm	LOAD CAP. kg
F BI A442 01 04	Multiplex	50	1000
F BI A242 01 04	Multiplex	40	800
F BK A442 01 04	3 cross-glued layers	50	1000
F BH A242 01 04	Grey laminate with solid wood	40	800
F BH B242 01 04	Grey laminate	40	800

Bottom shelf, ord. no. F BI 1340 00 00, load capacity: 130 kg



ORD. NO.	TYPE OF WORKTOP	THICKNESS mm	LOAD CAP. kg
F BI A442 04 04	Multiplex	50	1000
F BI A242 04 04	Multiplex	40	800
F BK A442 04 04	3 cross-glued layers	50	1000
F BH A242 04 04	Grey laminate with solid wood	40	800
F BH B242 04 04	Grey laminate	40	800

Bottom shelf, ord. no. F BI 1340 00 00, load capacity: 130 kg

ORD. NO.	TYPE OF WORKTOP	THICKNESS mm	LOAD CAP. kg
F BI A442 10 04	Multiplex	50	1000
F BI A242 10 04	Multiplex	40	800
F BK A442 10 04	3 cross-glued layers	50	1000
F BH A242 10 04	Grey laminate with solid wood	40	800
F BH B242 10 04	Grey laminate	40	800

Bottom shelf, ord. no. F BI 1340 00 00, load capacity: 130 kg



ORD. NO.	TYPE OF WORKTOP	THICKNESS mm	LOAD CAP. kg
F BI A442 16 04	Multiplex	50	1500
F BI A242 16 04	Multiplex	40	1500
F BK A442 16 04	3 cross-glued layers	50	1500
F BH A242 16 04	Grey laminate with solid wood	40	1500
F BH B242 16 04	Grey laminate	40	1500

Bottom shelf, ord. no. F BI 0773 01 01, load capacity: 180 kg

ORD. NO.	TYPE OF WORKTOP	THICKNESS mm	LOAD CAP. kg
F BI A442 34 04	Multiplex	50	1500
F BI A242 34 04	Multiplex	40	1500
F BK A442 34 04	3 cross-glued layers	50	1500
F BH A242 34 04	Grey laminate with solid wood	40	1500
F BH B242 34 04	Grey laminate	40	1500

Bottom shelf, ord. no. F BI 0773 01 01, load capacity: 180 kg

RAL 7000 F.01

RAL 6011 F.02

RAL 5012 F.04

RAL 7035 F.08

KEY ■

■ Sets of partitions see page A72 - A73

- PE = Retractable shelf
- All indicated loads are net and refer to evenly distributed weights



LENGTH = 1500 mm DEPTH = 750 mm (27x36 Eh)

SERIES WORK 15



■ RAL 5012

WORKSTATION**ORD. NO.****F BH A342 S1 04****Dimensions mm 1500x800x840/2110 h**

Tools, drawer partitioning sets and chair excluded

■ **INFO**

RAL 7000 F.01

RAL 6011 F.02

RAL 5012 F.04

RAL 7035 F.08

www.famispa.com

SERIES WORK 20

LENGTH = 2000 mm DEPTH = 800 mm (27x36 Eh)



ORD. NO. F BI G570 S1 04
RAL 5012

**WORKSTATION****ORD. NO.****F BI G570 S1 04**

Dimensions mm 2000x800x850/2120 h

Tools and drawer partitioning sets excluded

All the workbenches series WORK components are supplied without pre-drilling and bolts. To fix the components to the workbenches series WORK it is necessary to order the following **FIXING MATERIAL**:

**ORD. NO. F BL 9021 00 00**

For bench leg, adjustable bench leg, bench leg with wheels, cabinet with steel vice, bench leg for power fittings

ORD. NO. F BL 9011 00 00

Cabinets with shelves or doors

RAL 7000 F.01

RAL 6011 F.02

RAL 5012 F.04

RAL 7035 F.08

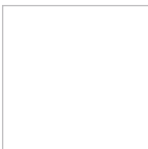
SUPPLEMENTARY PARTS ■

■ **Spare key.** Always indicate the number on the cylinder lock of the key to be replaced.

ORD. NO. R CSC 0002 00

■ **Master key.** This type of key opens all the 45 and 46 series locks.

ORD. NO. R CSC 0001 00



LENGTH = 2000 mm DEPTH = 800 mm (27x36 Eh)

SERIES WORK 20-80

SHELVES 800 mm DEEP

ORD. NO.	TYPE OF WORKTOP	THICKNESS mm	LOAD CAP. kg
F BI A570 01 04	Multiplex	50	700
F BI A370 01 04	Multiplex	40	500
F BK A570 01 04	3 cross-glued layers	50	700
F BH A370 01 04	Grey laminate with solid wood	40	500
F BH B370 01 04	Grey laminate	40	500

Bottom shelf, ord. no. F BI 1840 00 00, load capacity: 85 kg



ORD. NO.	TYPE OF WORKTOP	THICKNESS mm	LOAD CAP. kg
F BI A570 04 04	Multiplex	50	700
F BI A370 04 04	Multiplex	40	500
F BK A570 04 04	3 cross-glued layers	50	700
F BH A370 04 04	Grey laminate with solid wood	40	500
F BH B370 04 04	Grey laminate	40	500

Bottom shelf, ord. no. F BI 1840 00 00, load capacity: 85 kg



ORD. NO.	TYPE OF WORKTOP	THICKNESS mm	LOAD CAP. kg
F BI A570 10 04	Multiplex	50	700
F BI A370 10 04	Multiplex	40	500
F BK A570 10 04	3 cross-glued layers	50	700
F BH A370 10 04	Grey laminate with solid wood	40	500
F BH B370 10 04	Grey laminate	40	500

Bottom shelf, ord. no. F BI 1840 00 00, load capacity: 85 kg



ORD. NO.	TYPE OF WORKTOP	THICKNESS mm	LOAD CAP. kg
F BI A570 16 04	Multiplex	50	1000
F BI A370 16 04	Multiplex	40	800
F BK A570 16 04	3 cross-glued layers	50	1000
F BH A370 16 04	Grey laminate with solid wood	40	800
F BH B370 16 04	Grey laminate	40	800

Bottom shelf, ord. no. F BI 1275 01 01, load capacity: 130 kg



ORD. NO.	TYPE OF WORKTOP	THICKNESS mm	LOAD CAP. kg
F BI A570 40 04	Multiplex	50	1000
F BI A370 40 04	Multiplex	40	800
F BK A570 40 04	3 cross-glued layers	50	1000
F BH A370 40 04	Grey laminate with solid wood	40	800
F BH B370 40 04	Grey laminate	40	800

Bottom shelf, ord. no. F BI 1275 01 01, load capacity: 130 kg

KEY



- PE = Retractable shelf
- All indicated loads are net and refer to evenly distributed weights

RAL 7000 F.01 RAL 6011 F.02 RAL 5012 F.04 RAL 7035 F.08

■ Sets of partitions see page A72 - A73



SERIES WORK 20-75

LENGTH = 2000 mm DEPTH = 750 mm (27x36 Eh)

SHELVES 750 mm DEEP

ORD. NO.	TYPE OF WORKTOP	THICKNESS mm	LOAD CAP. kg
F BI A470 01 04	Multiplex	50	700
F BI A270 01 04	Multiplex	40	500
F BK A470 01 04	3 cross-glued layers	50	700
F BH A270 01 04	Grey laminate with solid wood	40	500
F BH B270 01 04	Grey laminate	40	500

Bottom shelf, ord. no. F BI 1840 00 00, load capacity: 85 kg



ORD. NO.	TYPE OF WORKTOP	THICKNESS mm	LOAD CAP. kg
F BI A470 04 04	Multiplex	50	700
F BI A270 04 04	Multiplex	40	500
F BK A470 04 04	3 cross-glued layers	50	700
F BH A270 04 04	Grey laminate with solid wood	40	500
F BH B270 04 04	Grey laminate	40	500

Bottom shelf, ord. no. F BI 1840 00 00, load capacity: 85 kg



ORD. NO.	TYPE OF WORKTOP	THICKNESS mm	LOAD CAP. kg
F BI A470 10 04	Multiplex	50	700
F BI A270 10 04	Multiplex	40	500
F BK A470 10 04	3 cross-glued layers	50	700
F BH A270 10 04	Grey laminate with solid wood	40	500
F BH B270 10 04	Grey laminate	40	500

Bottom shelf, ord. no. F BI 1840 00 00, load capacity: 85 kg



ORD. NO.	TYPE OF WORKTOP	THICKNESS mm	LOAD CAP. kg
F BI A470 16 04	Multiplex	50	1000
F BI A270 16 04	Multiplex	40	800
F BK A470 16 04	3 cross-glued layers	50	1000
F BH A270 16 04	Grey laminate with solid wood	40	800
F BH B270 16 04	Grey laminate	40	800

Bottom shelf, ord. no. F BI 1275 01 01, load capacity: 130 kg



ORD. NO.	TYPE OF WORKTOP	THICKNESS mm	LOAD CAP. kg
F BI A470 40 04	Multiplex	50	1000
F BI A270 40 04	Multiplex	40	800
F BK A470 40 04	3 cross-glued layers	50	1000
F BH A270 40 04	Grey laminate with solid wood	40	800
F BH B270 40 04	Grey laminate	40	800

Bottom shelf, ord. no. F BI 1275 01 01, load capacity: 130 kg

RAL 7000 F.01

RAL 6011 F.02

RAL 5012 F.04

RAL 7035 F.08

KEY ■

■ Sets of partitions see page A72 - A73

- PE = Retractable shelf
- All indicated loads are net and refer to evenly distributed weights



LENGTH = 2000 mm DEPTH = 750 mm (27x36 Eh)

SERIES WORK 20



■ RAL 7035

WORKSTATION

ORD. NO.

F BI B570 S1 08

Dimensions mm 2000x800x900 h

Tools and drawer partitioning sets excluded

■ **INFO**

RAL 7000 F.01 RAL 6011 F.02 RAL 5012 F.04 RAL 7035 F.08

■ Sets of partitions see pages **A180**



www.famispa.com

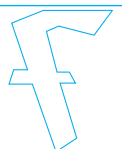

SERIES WORK 25

LENGTH = 2500 mm DEPTH = 800 mm (27x36 Eh)



ORD. NO. F BI A584 S1 04
RAL 5012

**WORKSTATION****ORD. NO.****F BI A584 S1 04**

Dimensions mm 2500x800x750/1150 h

Tools and drawer partitioning sets excluded

All the workbenches series WORK components are supplied without pre-drilling and bolts. To fix the components to the workbenches series WORK it is necessary to order the following **FIXING MATERIAL**:

**ORD. NO. F BL 9021 00 00**

For bench leg, adjustable bench leg, bench leg with wheels, cabinet with steel vice, bench leg for power fittings

ORD. NO. F BL 9011 00 00

Cabinets with shelves or doors

RAL 7000 F.01

RAL 6011 F.02

RAL 5012 F.04

RAL 7035 F.08

SUPPLEMENTARY PARTS ■

■ **Spare key.** Always indicate the number on the cylinder lock of the key to be replaced.

ORD. NO. R CSC 0002 00

■ **Master key.** This type of key opens all the 45 and 46 series locks.

ORD. NO. R CSC 0001 00



LENGTH = 2500 mm DEPTH = 800 mm (27x36 Eh)

SERIES WORK 25-80

SHELVES 800 mm DEEP



ORD. NO.	TYPE OF WORKTOP	THICKNESS mm	LOAD CAP. kg
F BI A584 01 04	Multiplex	50	1000
F BI A384 01 04	Multiplex	40	800
F BK A584 01 04	3 cross-glued layers	50	1000
F BH A384 01 04	Grey laminate with solid wood	40	800
F BH B384 01 04	Grey laminate	40	800

Bottom shelf, ord. no. F BI 2100 00 00, load capacity: 260 kg



ORD. NO.	TYPE OF WORKTOP	THICKNESS mm	LOAD CAP. kg
F BI A584 04 04	Multiplex	50	1000
F BI A384 04 04	Multiplex	40	800
F BK A584 04 04	3 cross-glued layers	50	1000
F BH A384 04 04	Grey laminate with solid wood	40	800
F BH B384 04 04	Grey laminate	40	800

Bottom shelf, ord. no. F BI 2100 00 00, load capacity: 260 kg

ORD. NO.	TYPE OF WORKTOP	THICKNESS mm	LOAD CAP. kg
F BI A584 46 04	Multiplex	50	1000
F BI A384 46 04	Multiplex	40	800
F BK A584 46 04	3 cross-glued layers	50	1000
F BH A384 46 04	Grey laminate with solid wood	40	800
F BH B384 46 04	Grey laminate	40	800

Bottom shelf, ord. no. F BI 2110 01 01, load capacity: 260 kg



With 4 Schuko sockets 220-250V 10A 2P+GND and thermomagnetic switch 2P 230V AC 10A, cabled

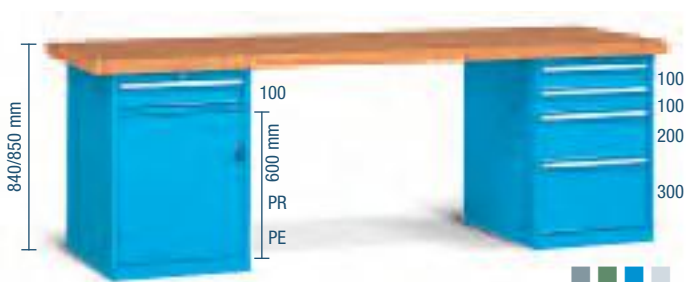

ORD. NO.	TYPE OF WORKTOP	THICKNESS mm	LOAD CAP. kg
F BI A584 28 04	Multiplex	50	1000
F BI A384 28 04	Multiplex	40	800
F BK A584 28 04	3 cross-glued layers	50	1000
F BH A384 28 04	Grey laminate with solid wood	40	800
F BH B384 28 04	Grey laminate	40	800

Bottom shelf, ord. no. F BI 1210 02 01, load capacity: 130 kg

KEY



- PE = Retractable shelf ■ PR = Adjustable shelf
- All indicated loads are net and refer to evenly distributed weights

RAL 7000 F.01 RAL 6011 F.02 RAL 5012 F.04 RAL 7035 F.08

■ Sets of partitions see page A72 - A73



SERIES WORK 25-75

LENGTH = 2500 mm DEPTH = 750 mm (27x36 Eh)

SHELVES 750 mm DEEP

ORD. NO.	TYPE OF WORKTOP	THICKNESS mm	LOAD CAP. kg
F BI A484 01 04	Multiplex	50	1000
F BI A284 01 04	Multiplex	40	800
F BK A484 01 04	3 cross-glued layers	50	1000
F BH A284 01 04	Grey laminate with solid wood	40	800
F BH B284 01 04	Grey laminate	40	800

Bottom shelf, ord. no. F BI 2100 00 00, load capacity: 260 kg



ORD. NO.	TYPE OF WORKTOP	THICKNESS mm	LOAD CAP. kg
F BI A484 04 04	Multiplex	50	1000
F BI A284 04 04	Multiplex	40	800
F BK A484 04 04	3 cross-glued layers	50	1000
F BH A284 04 04	Grey laminate with solid wood	40	800
F BH B284 04 04	Grey laminate	40	800

Bottom shelf, ord. no. F BI 2100 00 00, load capacity: 260 kg

ORD. NO.	TYPE OF WORKTOP	THICKNESS mm	LOAD CAP. kg
F BI A484 46 04	Multiplex	50	1000
F BI A284 46 04	Multiplex	40	800
F BK A484 46 04	3 cross-glued layers	50	1000
F BH A284 46 04	Grey laminate with solid wood	40	800
F BH B284 46 04	Grey laminate	40	800

Bottom shelf, ord. no. F BI 2110 01 01, load capacity: 260 kg



With 4 Schuko sockets 220-250V 10A 2P+GND and thermomagnetic switch 2P 230V AC 10A, cabled



ORD. NO.	TYPE OF WORKTOP	THICKNESS mm	LOAD CAP. kg
F BI A484 28 04	Multiplex	50	1000
F BI A284 28 04	Multiplex	40	800
F BK A484 28 04	3 cross-glued layers	50	1000
F BH A284 28 04	Grey laminate with solid wood	40	800
F BH B284 28 04	Grey laminate	40	800

Bottom shelf, ord. no. F BI 1210 02 01, load capacity: 130 kg

RAL 7000 F.01

RAL 6011 F.02

RAL 5012 F.04

RAL 7035 F.08

KEY ■

■ Sets of partitions see page A72 - A73

- PE = Retractable shelf
- PR = Adjustable shelf
- All indicated loads are net and refer to evenly distributed weights



LENGTH = 2500 mm DEPTH = 750 mm (27x36 Eh)

SERIES WORK 25



■ RAL 7035

WORKSTATION

ORD. NO.

F BI A584 S2 08

Dimensions mm 2500x800x900 h

Tools and drawer partitioning sets excluded

■ **INFO**

RAL 7000 F.01 RAL 6011 F.02 RAL 5012 F.04 RAL 7035 F.08

■ Sets of partitions see page A180



www.famispa.com



SERIES WORK 30

LENGTH = 3000 mm DEPTH = 800 mm (27x36 Eh)



ORD. NO. F BI A598 S1 04
RAL 5012

**WORKSTATION****ORD. NO.****F BI A598 S1 04****Dimensions mm 3000x800x850/2120 h**

Complete with multi-purpose back panels. Tools and set of partitioning material for drawers excluded.

All the workbenches series WORK components are supplied without pre-drilling and bolts. To fix the components to the workbenches series WORK it is necessary to order the following **FIXING MATERIAL**:

**ORD. NO. F BL 9021 00 00**

For bench leg, adjustable bench leg, bench leg with wheels, cabinet with steel vice, bench leg for power fittings

ORD. NO. F BL 9011 00 00

Cabinets with shelves or doors

RAL 7000 F.01

RAL 6011 F.02

RAL 5012 F.04

RAL 7035 F.08

SUPPLEMENTARY PARTS ■

■ **Spare key.** Always indicate the number on the cylinder lock of the key to be replaced.

ORD. NO. R CSC 0002 00

■ **Master key.** This type of key opens all the 45 and 46 series locks.

ORD. NO. R CSC 0001 00



LENGTH = 3000 mm DEPTH = 800 mm (27x36 Eh)

SERIES WORK 30-80

SHELVES 800 mm DEEP

ORD. NO.	TYPE OF WORKTOP	THICKNESS mm	LOAD CAP. kg
F BI A598 01 04	Multiplex	50	800
F BK A598 01 04	3 cross-glued layers	50	800
F BH A598 01 04	Grey laminate with solid wood	50	800
F BH B598 01 04	Grey laminate	50	800

Bottom shelf, ord. no. F BI 2690 00 00, load capacity: 210 kg



ORD. NO.	TYPE OF WORKTOP	THICKNESS mm	LOAD CAP. kg
F BI A598 04 04	Multiplex	50	800
F BK A598 04 04	3 cross-glued layers	50	800
F BH A598 04 04	Grey laminate with solid wood	50	800
F BH B598 04 04	Grey laminate	50	800

Bottom shelf, ord. no. F BI 2690 00 00, load capacity: 210 kg

ORD. NO.	TYPE OF WORKTOP	THICKNESS mm	LOAD CAP. kg
F BI A598 22 04	Multiplex	50	800
F BK A598 22 04	3 cross-glued layers	50	800
F BH A598 22 04	Grey laminate with solid wood	50	800
F BH B598 22 04	Grey laminate	50	800

Bottom shelf, ord. no. F BI 2510 01 01, load capacity: 210 kg

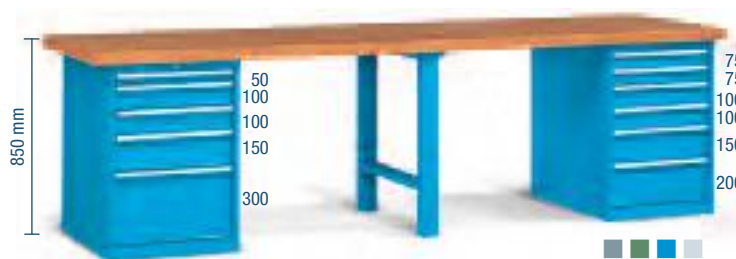

ORD. NO.	TYPE OF WORKTOP	THICKNESS mm	LOAD CAP. kg
F BI A598 16 04	Multiplex	50	1500
F BK A598 16 04	Multiplex	50	1500
F BH A598 16 04	3 cross-glued layers	50	1500
F BH B598 16 04	Grey laminate with solid wood	50	1500

Bottom shelf, ord. no. F BI 1710 02 01, load capacity: 360 kg

KEY



- PE = Retractable shelf
- All indicated loads are net and refer to evenly distributed weights

RAL 7000 F.01 RAL 6011 F.02 RAL 5012 F.04 RAL 7035 F.08

■ Sets of partitions see page A72 - A73



SERIES WORK 30-75

LENGTH = 3000 mm DEPTH = 750 mm (27x36 Eh)

SHELVES 750 mm DEEP

ORD. NO.	TYPE OF WORKTOP	THICKNESS mm	LOAD CAP. kg
F BI A498 01 04	Multiplex	50	800
F BK A498 01 04	3 cross-glued layers	50	800
F BH A498 01 04	Grey laminate with solid wood	50	800
F BH B498 01 04	Grey laminate	50	800

Bottom shelf, ord. no. F BI 2690 00 00, load capacity: 210 kg



ORD. NO.	TYPE OF WORKTOP	THICKNESS mm	LOAD CAP. kg
F BI A498 04 04	Multiplex	50	800
F BK A498 04 04	3 cross-glued layers	50	800
F BH A498 04 04	Grey laminate with solid wood	50	800
F BH B498 04 04	Grey laminate	50	800

Bottom shelf, ord. no. F BI 2690 00 00, load capacity: 210 kg

ORD. NO.	TYPE OF WORKTOP	THICKNESS mm	LOAD CAP. kg
F BI A498 22 04	Multiplex	50	800
F BK A498 22 04	3 cross-glued layers	50	800
F BH A498 22 04	Grey laminate with solid wood	50	800
F BH B498 22 04	Grey laminate	50	800

Bottom shelf, ord. no. F BI 2510 01 01, load capacity: 210 kg

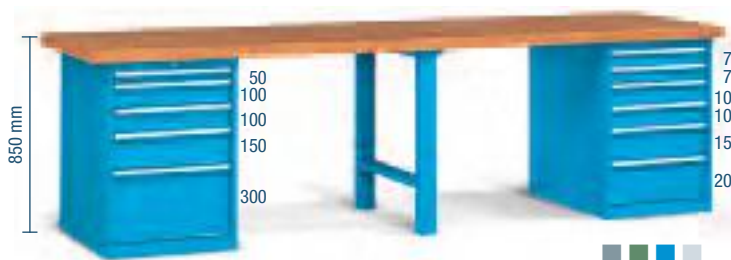

ORD. NO.	TYPE OF WORKTOP	THICKNESS mm	LOAD CAP. kg
F BI A498 16 04	Multiplex	50	1500
F BK A498 16 04	Multiplex	50	1500
F BH A498 16 04	3 cross-glued layers	50	1500
F BH B498 16 04	Grey laminate with solid wood	50	1500

Bottom shelf, ord. no. F BI 1710 02 01, load capacity: 360 kg

RAL 7000 F.01

RAL 6011 F.02

RAL 5012 F.04

RAL 7035 F.08

KEY ■

■ Sets of partitions see page A72 - A73

- PE = Retractable shelf ■ PR = Adjustable shelf
- All indicated loads are net and refer to evenly distributed weights



LENGTH = 3000 mm DEPTH = 750 mm (27x36 Eh)

SERIES WORK 30

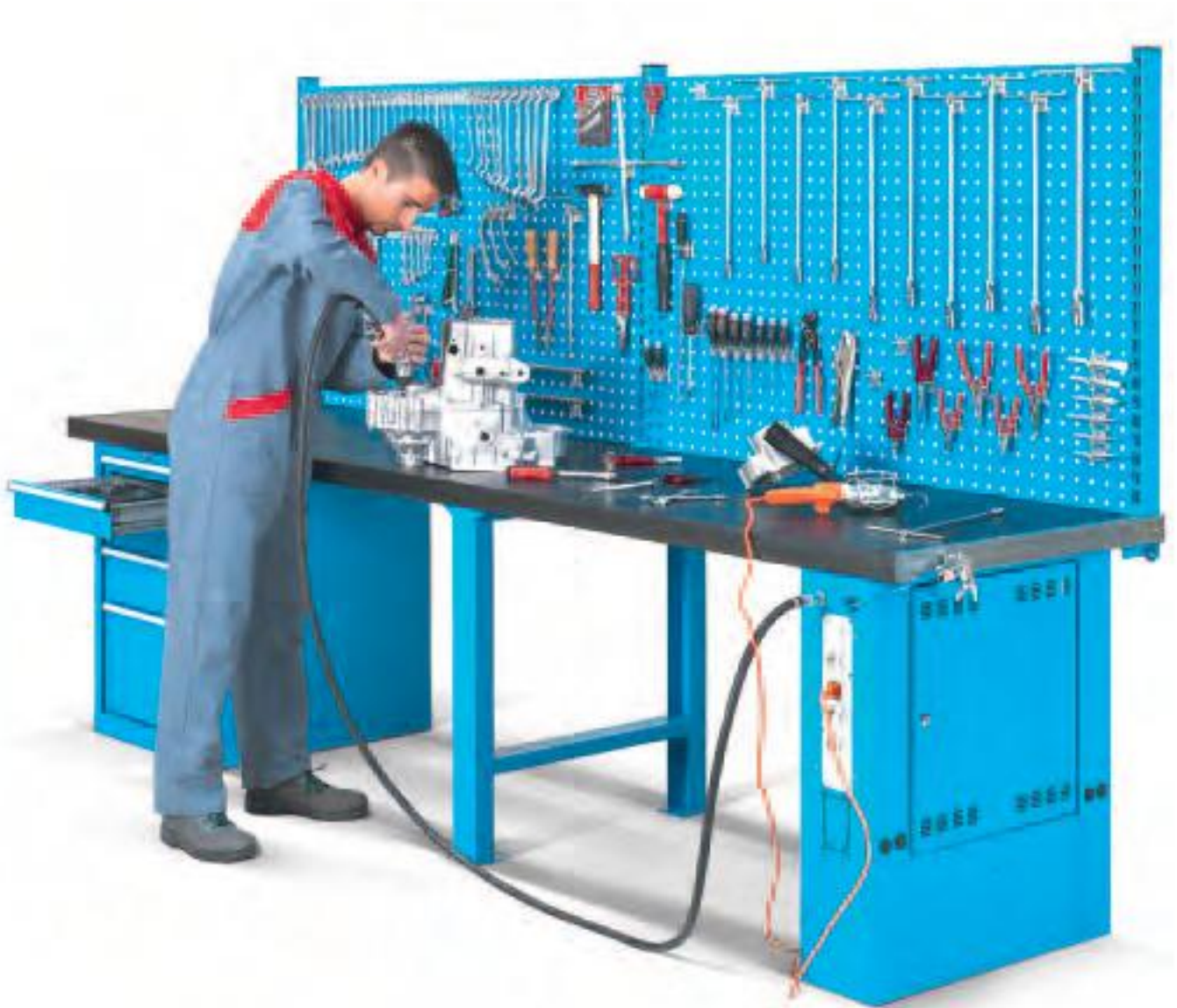

■ RAL 5012

WORKSTATION**ORD. NO.****F BI G598 S1 04****Dimensions mm 3000x800x900/1830 h**

Tools and set of partitioning material for drawers excluded

■ **INFO**

RAL 7000 F.01

RAL 6011 F.02

RAL 5012 F.04

RAL 7035 F.08

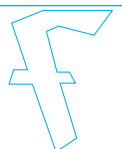
www.famispa.com

SERIES WORK-ROL



27 EH (447 mm)



36 EH (600 mm)

All the workbenches series WORK components are supplied without pre-drilling and bolts. To fix the components to the workbenches series WORK it is necessary to order the following **FIXING MATERIAL**:

**ORD. NO. F BL 9021 00 00**

For bench leg, adjustable bench leg, bench leg with wheels, cabinet with steel vice, bench leg for power fittings

ORD. NO. F BL 9011 00 00

Cabinets with shelves or doors

RAL 7000 F.01 RAL 6011 F.02 RAL 5012 F.04 RAL 7035 F.08

SUPPLEMENTARY PARTS ■

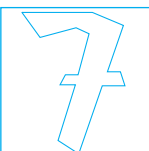

■ **Spare key.** Always indicate the number on the cylinder lock of the key to be replaced.

ORD. NO. R CSC 0002 00

■ **Master key.** This type of key opens all the 45 and 46 series locks.

ORD. NO. R CSC 0001 00



LENGTH = 1300 mm DEPTH = 800 mm (27x36 Eh)

SERIES WORK-ROL

BACK AND SIDE UPSTAND OF MULTIPLEX



SIDE UPSTAND OF MULTIPLEX

ORD. NO.	DIM. mm	FOR WORKSTATION
F BL 5610 00 00	762x12x100 h	750 mm
F BL 5635 00 00	770x20x150 h	750 mm
F BL 5645 00 00	770x20x200 h	750 mm
F BL 5630 00 00	812x12x100 h	800 mm
F BL 5640 00 00	820x20x150 h	800 mm
F BL 5650 00 00	820x20x200 h	800 mm



BACK UPSTAND OF MULTIPLEX

ORD. NO.	DIM. mm	FOR WORKSTATION
F BL 5720 00 00	1300x12x100 h	1300 mm
F BL 5790 00 00	1300x20x150 h	1300 mm
F BL 5860 00 00	1300x20x200 h	1300 mm
F BL 5730 00 00	1500x12x100 h	1500 mm
F BL 5800 00 00	1500x20x150 h	1500 mm
F BL 5870 00 00	1500x20x200 h	1500 mm
F BL 5750 00 00	2000x12x100 h	2000 mm
F BL 5820 00 00	2000x20x150 h	2000 mm
F BL 5890 00 00	2000x20x200 h	2000 mm

ORD. NO.

F CA C328 S1 04

Complete with upstands and vice

Dimensions mm 1350x820x1000 h

Tools and drawer partitioning sets excluded



■ RAL 5012

■ RAL 7000+
■ RAL 5012



■ Mobile workstations FLEXA see page A38 - A51

■ INFO

RAL 7000 F.01

RAL 6011 F.02

RAL 5012 F.04

RAL 7035 F.08

www.famispa.com

SERIES WORK-ROL 13-80

LENGTH = 1300 mm DEPTH = 750 mm (27x36 Eh)

SHELVES 800 mm DEEP



ORD. NO.	TYPE OF WHEEL	THICKNESS mm	Ø mm	LOAD CAP. kg
F CC C328 13 04	Standard rubber	40	125	220
F CC Q328 13 04	Nylon	40	125	500

- Complete with:
- 2 braked swivel wheels Ø 125 mm
 - 2 fixed wheels Ø 125 mm
 - 3 normal extension drawers
 - 1 bench leg with power fittings
 - 1 electrical system
 - 1 pneumatic system

Dimensions mm 1330x800x890 h

ORD. NO.	TYPE OF WHEEL	THICKNESS mm	Ø mm	LOAD CAP. kg
F CC C328 14 04	Standard rubber	40	125	220
F CC Q328 14 04	Nylon	40	125	500

- Complete with:
- 2 braked swivel wheels, 2 fixed wheels Ø 125 mm
 - 3 normal extension drawers
 - 1 roller shutter cabinet with 1 set of 16 hooks (tools excluded)
 - 2 support columns with dual slots, 1 perforated back panel
 - 1 2x18W lighting system and 1 bench leg with power fittings
 - 1 electrical system, 1 pneumatic system

Dimensions mm 1330x800x2160 h



■ Mobile workstations FLEXA see page A38 - A51

■ RAL 7035+ ■ RAL 5012

RAL 7000 F.01 RAL 6011 F.02 RAL 5012 F.04 RAL 7035 F.08

KEY ■

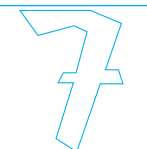

■ Sets of partitions see page A72 - A73

■ All indicated loads are net and refer to evenly distributed weights



SHELVES 800 mm DEEP



ORD. NO.	TYPE OF WHEEL	THICKNESS mm	Ø mm	LOAD CAP. kg
F CA C328 02 04	Standard rubber	40	125	240
F CA Q328 02 04	Nylon	40	125	600
Complete with:				
2 braked swivel wheels Ø 125 mm				
2 fixed wheels Ø 125 mm				
Dimensions mm 1330x800x840 h				

SHELVES 750 mm DEEP



ORD. NO.	TYPE OF WHEEL	THICKNESS mm	Ø mm	LOAD CAP. kg
F CA C228 02 04	Standard rubber	40	125	240
F CA Q228 02 04	Nylon	40	125	600
Complete with:				
2 braked swivel wheels Ø 125 mm				
2 fixed wheels Ø 125 mm				
Dimensions mm 1330x750x840 h				

SHELVES 800 mm DEEP



ORD. NO.	TYPE OF WHEEL	THICKNESS mm	Ø mm	LOAD CAP. kg
F CA C328 03 04	Standard rubber	40	125	220
F CA Q328 03 04	Nylon	40	125	600
Complete with:				
2 braked swivel wheels Ø 125 mm				
2 fixed wheels Ø 125 mm				
Dimensions mm 1330x800x840 h				

SHELVES 750 mm DEEP



ORD. NO.	TYPE OF WHEEL	THICKNESS mm	Ø mm	LOAD CAP. kg
F CA C228 03 04	Standard rubber	40	125	220
F CA Q228 03 04	Nylon	40	125	600
Complete with:				
2 braked swivel wheels Ø 125 mm				
2 fixed wheels Ø 125 mm				
Dimensions mm 1330x750x840 h				

KEY

RAL 7000 F.01

RAL 6011 F.02

RAL 5012 F.04

RAL 7035 F.08



- Sets of partitions see page A72 - A73
- All indicated loads are net and refer to evenly distributed weights



LENGTH = 1500 mm DEPTH = 800/750 mm (27x36 Eh)

SERIES WORK-ROL 15-80/15-75

SHELVES 800 mm DEEP



ORD. NO.	TYPE OF WHEEL	THICKNESS mm	Ø mm	LOAD CAP. kg
F CA C342 02 04	Standard rubber	40	125	240
F CA Q342 02 04	Nylon	40	125	600
Complete with: 2 braked swivel wheels, 2 fixed wheels Ø 125 mm				
Dimensions mm 1530x800x840 h				

SHELVES 750 mm DEEP



ORD. NO.	TYPE OF WHEEL	THICKNESS mm	Ø mm	LOAD CAP. kg
F CA C242 02 04	Standard rubber	40	125	240
F CA Q242 02 04	Nylon	40	125	600
Complete with: 2 braked swivel wheels, 2 fixed wheels Ø 125 mm				
Dimensions mm 1530x750x840 h				

SHELVES 800 mm DEEP



ORD. NO.	TYPE OF WHEEL	THICKNESS mm	Ø mm	LOAD CAP. kg
F CA C342 04 04	Standard rubber	40	125	200
F CA Q342 04 04	Nylon	40	125	600
Complete with: 2 braked swivel wheels, 2 fixed wheels Ø 125 mm				
Dimensions mm 1530x800x840 h				

SHELVES 750 mm DEEP



ORD. NO.	TYPE OF WHEEL	THICKNESS mm	Ø mm	LOAD CAP. kg
F CA C242 04 04	Standard rubber	40	125	200
F CA Q242 04 04	Nylon	40	125	600
Complete with: 2 braked swivel wheels, 2 fixed wheels Ø 125 mm				
Dimensions mm 1530x750x840 h				

SHELVES 800 mm DEEP



ORD. NO.	TYPE OF WHEEL	THICKNESS mm	Ø mm	LOAD CAP. kg
F CA C342 05 04	Standard rubber	40	125	240
F CA Q342 05 04	Nylon	40	125	600
Complete with: 2 braked swivel wheels, 2 fixed wheels Ø 125 mm				
Dimensions mm 1530x800x895/1295 h				

SHELVES 750 mm DEEP



ORD. NO.	TYPE OF WHEEL	THICKNESS mm	Ø mm	LOAD CAP. kg
F CA C242 05 04	Standard rubber	40	125	240
F CA Q242 05 04	Nylon	40	125	600
Complete with: 2 braked swivel wheels, 2 fixed wheels Ø 125 mm				
Dimensions mm 1530x750x895/1295 h				

RAL 7000 F.01

RAL 6011 F.02

RAL 5012 F.04

RAL 7035 F.08

KEY ■

- Sets of partitions see page A72 - A73
- All indicated loads are net and refer to evenly distributed weights



LENGTH = 2000 mm DEPTH = 800/750 mm (27x36 Eh)

SERIES WORK-ROL 20-80/20-75

SHELVES 800 mm DEEP

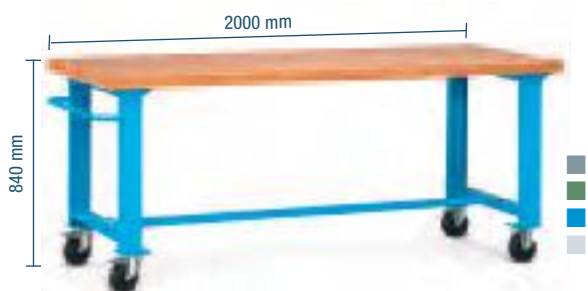

ORD. NO.	TYPE OF WHEEL	THICKNESS mm	Ø mm	LOAD CAP. kg
F CA C370 02 04	Standard rubber	40	125	220
F CA Q370 02 04	Nylon	40	125	500

Complete with: 2 braked swivel wheels, 2 fixed wheels Ø 125 mm
Dimensions mm 2030x800x840 h

SHELVES 750 mm DEEP

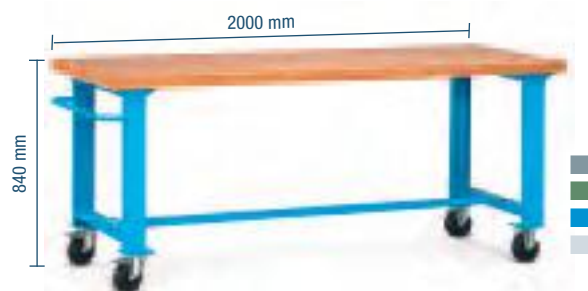

ORD. NO.	TYPE OF WHEEL	THICKNESS mm	Ø mm	LOAD CAP. kg
F CA C270 02 04	Standard rubber	40	125	220
F CA Q270 02 04	Nylon	40	125	500

Complete with: 2 braked swivel wheels, 2 fixed wheels Ø 125 mm
Dimensions mm 2030x750x840 h

SHELVES 800 mm DEEP

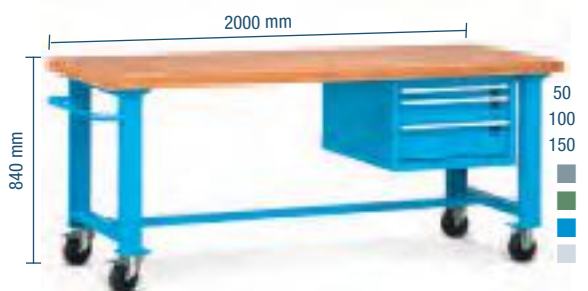

ORD. NO.	TYPE OF WHEEL	THICKNESS mm	Ø mm	LOAD CAP. kg
F CA C370 04 04	Standard rubber	40	125	180
F CA Q370 04 04	Nylon	40	125	500

Complete with: 2 braked swivel wheels, 2 fixed wheels Ø 125 mm
Dimensions mm 2030x800x840 h

SHELVES 750 mm DEEP

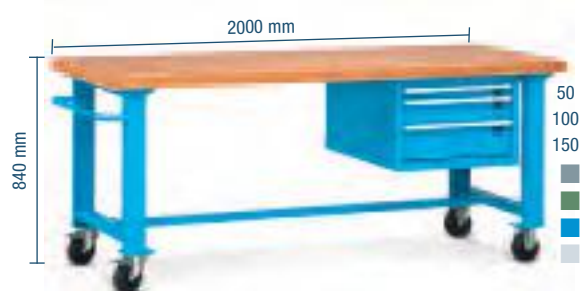

ORD. NO.	TYPE OF WHEEL	THICKNESS mm	Ø mm	LOAD CAP. kg
F CA C270 04 04	Standard rubber	40	125	180
F CA Q270 04 04	Nylon	40	125	500

Complete with: 2 braked swivel wheels, 2 fixed wheels Ø 125 mm
Dimensions mm 2030x750x840 h

SHELVES 800 mm DEEP



ORD. NO.	TYPE OF WHEEL	THICKNESS mm	Ø mm	LOAD CAP. kg
F CA C370 05 04	Standard rubber	40	125	220
F CA Q370 05 04	Nylon	40	125	500

Complete with: 2 braked swivel wheels, 2 fixed wheels Ø 125 mm
Dimensions mm 2030x800x895/1295 h

SHELVES 750 mm DEEP



ORD. NO.	TYPE OF WHEEL	THICKNESS mm	Ø mm	LOAD CAP. kg
F CA C270 05 04	Standard rubber	40	125	220
F CA Q270 05 04	Nylon	40	125	500

Complete with: 2 braked swivel wheels, 2 fixed wheels Ø 125 mm
Dimensions mm 2030x750x895/1295 h

KEY

RAL 7000 F.01 RAL 6011 F.02 RAL 5012 F.04 RAL 7035 F.08



- Sets of partitions see page A72 - A73
- All indicated loads are net and refer to evenly distributed weights

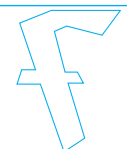

SERIES WORK

BENCH LEGS

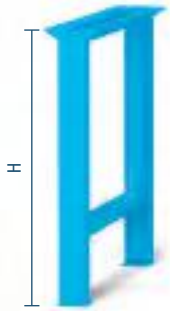

ORD. NO.	DIM. mm
F BL 6010 00 04	80x715x700 h
F BL 6025 00 04	80x715x800 h
F BL 6035 00 04	80x715x830 h
F BL 6040 00 04	80x715x850 h

■ 01 ■ 02 ■ 04 ■ 08

ADJUSTABLE BENCH LEGS



ORD. NO.	DIM. mm
F BL 6045 00 58	80x715x700/1100 h

■ 57 ■ 60 ■ 58 ■ 59

BENCH LEGS WITH WHEELS

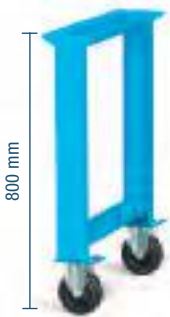

ORD. NO.	TYPE OF WHEEL	Ø mm
F BL 6075 A0 04	Standard rubber	125
F BL 6075 G0 04	No-smear	125
F BL 6075 D0 04	Elastic rubber	125
F BL 6075 K0 04	Polyurethane	125
F BL 6075 N0 04	Nylon	125

Complete with: 2 fixed wheels Ø125 mm

■ 01 ■ 02 ■ 04 ■ 08

BENCH LEGS WITH WHEELS



ORD. NO.	TYPE OF WHEEL	Ø mm
F BL 6090 C0 04	Standard rubber	125
F BL 6090 I0 04	No-smear	125
F BL 6090 F0 04	Elastic rubber	125
F BL 6090 M0 04	Polyurethane	125
F BL 6090 Q0 04	Nylon	125

Complete with: 2 braked swivel wheels Ø125 mm

■ 01 ■ 02 ■ 04 ■ 08

ADJUSTABLE BENCH LEGS WITH WHEELS



ORD. NO.	TYPE OF WHEEL	Ø mm
F BL 6055 A0 58	Standard rubber	125
F BL 6055 G0 58	No-smear	125
F BL 6055 D0 58	Elastic rubber	125
F BL 6055 K0 58	Polyurethane	125
F BL 6055 N0 58	Nylon	125

Complete with: 2 fixed wheels Ø125 mm

■ 57 ■ 60 ■ 58 ■ 59

ADJUSTABLE BENCH LEGS WITH WHEELS



ORD. NO.	TYPE OF WHEEL	Ø mm
F BL 6056 C0 58	Standard rubber	125
F BL 6056 I0 58	No-smear	125
F BL 6056 F0 58	Elastic rubber	125
F BL 6056 M0 58	Polyurethane	125
F BL 6056 Q0 58	Nylon	125

Complete with: 2 braked swivel wheels Ø125 mm

■ 57 ■ 60 ■ 58 ■ 59

CONNECTION PIECE FOR MOBILE WORKSTATION



■ 01 ■ 02 ■ 04 ■ 08

ORD. NO. CONNECTION PIECE FOR WORKSTATION LENGTH mm

F BL 6605 00 04 980 mm 1300

ORD. NO. CONNECTION PIECE FOR WORKSTATION LENGTH mm

F BL 6610 00 04 1180 mm 1500

ORD. NO. CONNECTION PIECE FOR WORKSTATION LENGTH mm

F BL 6620 00 04 1680 mm 2000

BENCH LEG WITH POWER FITTINGS

ORD. NO.	DIM. mm
F BL 6120 01 04	190x695x700 h
F BL 6125 01 04	190x695x800 h
F BL 6130 01 04	190x695x830 h
F BL 6135 01 04	190x695x850 h

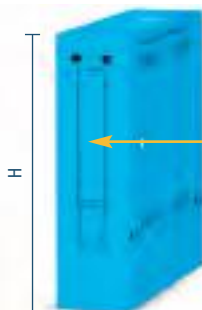

Electrical and pneumatic system see page C31.



■ 01 ■ 02 ■ 04 ■ 08

DEPTH = 726 mm (27x36 Eh)

SERIES WORK

PNEUMATIC SYSTEM WITH SINGLE WINDER AND FILTER



ORD. NO.	BENCH LEG HEIGHT mm
F BL 9670 70 07	700
F BL 9670 80 07	800
F BL 9670 83 07	830
F BL 9670 85 07	850

Detail of fixed rear outlet

Detail of fixed reducer assembly with lubricator on request

The pneumatic system includes:

- 1 fix rear inlet with Ø 10 mm hose and connector (1/4") with pin (Ø 9–12 mm) used to link up to the pneumatic supply by means of an extension hose (not supplied standard).
- 1 front winder including 4 metres of hose with an internal diameter of 5,5 and a 1/4" threaded tool connector, capacity approx. 9 litres per second*.
- 1 fixed front outlet with Ø 10 mm hose and 1/4" threaded connector complete with plug, capacity approx. 11 litres per second*.
- 1 filter reducer assembly with pressure gauge which can be used at maximum pressure of 10 bar, capacity approx. 11 metres per second* at an operating pressure of 6.3 bar.

*capacity can vary according to the technical characteristics of the pneumatic supply to which the system is connected.

PNEUMATIC SYSTEM WITH SINGLE WINDER



ORD. NO.	BENCH LEG HEIGHT mm
F BL 9660 70 07	700
F BL 9660 80 07	800
F BL 9660 83 07	830
F BL 9660 85 07	850

Applicable on bench leg for power fittings only

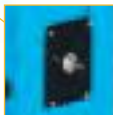

Detail of fixed rear outlet

The pneumatic system includes:

- 1 fix rear inlet with Ø 10 mm hose and connector (3/8") with pin (Ø 9–12 mm) used to link up to the pneumatic supply by means of an extension hose (not supplied standard).
- 1 front winder including 4 metres of hose with an internal diameter of 5,5 and a 1/4" threaded tool connector.
- 1 fixed front outlet with Ø 10 mm hose and 3/8" threaded connector complete with plug.

N.B. All the unions (except for those of the winder) are 3/8".

ELECTRIC SYSTEM



The bench legs for power fittings are supplied standard with a side door with a cylinder lock and 2 keys. An electric and/or a pneumatic system can be fitted in these bench legs. The socket box is also fitted standard with a thermo-magnetic switch 2P 230V AC 10A and is connected (with a hard-wearing cable sheath) to a heavy duty socket 220-240V 16A 2P+GND at the rear featuring a vertically sliding cover. The system is protected to IP30.

ORD. NO.	type and number of cabled sockets:					
	D	F	GB	I	CH	IL
F BL 9620 10 00	4	-	-	-	-	-
F BL 9620 20 00	-	4	-	-	-	-
F BL 9620 30 00	-	-	3	-	-	-
F BL 9620 40 00	-	-	-	4	-	-
F BL 9620 50 00	-	-	-	-	4	-
F BL 9620 70 00	-	-	-	-	-	4

The electric system includes a multiple socket box featuring 6 type of sockets:

- 4 sockets for large and small italian plugs 220-250V 10A 2P+GND
- 4 Schuko sockets 220-250V 10A 2P+GND
- 4 French sockets 220-250V 10A 2P+GND
- 3 British sockets 220-250V 10A 2P+GND
- 4 Swiss sockets 220-250V 10A 2P+GND
- 4 Israeli sockets 220-250V 10A 2P+GND

CABINET WITH STEEL VICE

ORD. NO.	DIM. mm
F BL 6105 01 04	312x726x800 h
F BL 6110 01 04	312x726x830 h
F BL 6115 01 04	312x726x850 h



The vice can rotate by 360°.

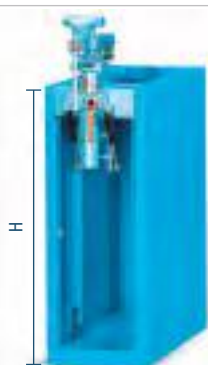

With steel vice 120 mm



1 Open the door and...



2 ...slide it until it completely enters the vice cabinet.



3 Pull up the vice and fix it with the relative knob.



4 Adjust the vice to the required height.

SERIES WORK STANDARD B

EMPTY CABINET PREPARED FOR DRAWERS 27x36 EH

ORD. NO.	USABLE HEIGHT mm	LOAD CAP. kg	DIMENSIONS mm
F DD 1020 00 04	200	3100	564x726x283 h
F DD 1030 00 04	300	3100	564x726x383 h
F DD 1050 00 04	500	3100	564x726x600 h
F DD 1060 00 04	600	3100	564x726x700 h
F DD 1070 00 04	700	3100	564x726x800 h
F DD 1072 00 04	725	3100	564x726x825 h
F DD 1075 00 04	750	3100	564x726x850 h
F DD 1090 00 04	900	3100	564x726x1000 h



■ 01 ■ 02 ■ 04 ■ 08

PLINTHS



■ 07

ORD. NO.	HEIGHT mm
F DD 9300 00 07	50
F DD 9330 00 07	100

EMPTY CABINET WITH DOOR WITH RIGHT-HAND OPENING

ORD. NO.	DOOR HEIGHT mm	USABLE HEIGHT mm	LOAD CAP. kg	DIMENSIONS mm
F DD 1260 D0 04	600	600	3100	564x726x700 h

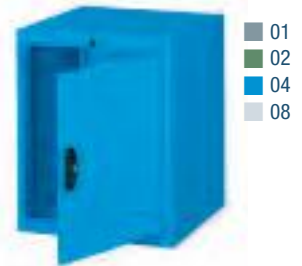

■ 01
■ 02
■ 04
■ 08

EMPTY CABINET WITH DOOR WITH LEFT-HAND OPENING

ORD. NO.	DOOR HEIGHT mm	USABLE HEIGHT mm	LOAD CAP. kg	DIMENSIONS mm
F DD 1261 D0 04	600	600	3100	564x726x700 h

■ Drawers cannot be fitted behind doors.

EMPTY CABINET PREPARED FOR DOORS AND DRAWERS

ORD. NO.	DOOR HEIGHT (A) mm	DRAWERS HEIGHT (B) mm	USABLE HEIGHT (C) mm	LOAD CAP. kg	DIMENSIONS mm
F DD 1150 00 04	400	75	500	3100	564x726x600 h
	400	175			
F DD 1160 00 04	425	150	600	3100	564x726x700 h
	500	75			
	400	275			
F DD 1170 00 04	425	250	700	3100	564x726x800 h
	500	175			
	575	100			
F DD 1172 00 04	600	75	725	3100	564x726x825 h
	400	300			
	425	275			
	500	200			
F DD 1175 00 04	575	125	750	3100	564x726x850 h
	600	100			
	400	325			
	425	300			
F DD 1190 00 04	500	225	900	3100	564x726x1000 h
	575	150			
	600	125			
	400	475			
F DD 1190 00 04	425	450	900	3100	564x726x1000 h
	500	375			
	575	300			
	600	275			

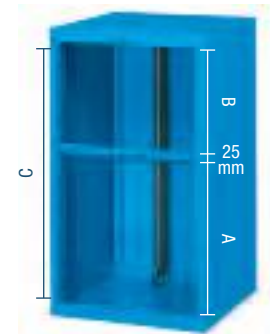

■ 01 ■ 02 ■ 04 ■ 08

■ Drawers cannot be fitted behind doors.

REVERSIBLE DOOR

ORD. NO.	HEIGHT (A) mm
F DD 9640 01 04	400
F DD 9642 01 04	425
F DD 9645 01 04	500
F DD 9649 01 04	575
F DD 9650 01 04	600



■ 01 ■ 02 ■ 04 ■ 08

■ Drawers cannot be fitted behind doors.

■ These doors can be fitted both with left-hand and right-hand opening.

SPARE LOCKS AND SPARE HANDLE

ORD. NO.
R CSR 0003 00
Spare lock (for cabinets)
R CSR 0035 00
Spare lock (for handle of the doors)
R XDA 0002 07
Spare handle (for doors)

DEPTH = 726 mm (27x36 Eh)

SERIES WORK STANDARD B

DRAWERS

ORD. NO.	FRONT HEIGHT mm	LOAD CAP. kg	USABLE DIMENSIONS mm
F DD 8050 00 04	50	60	447x600x36 h
F DD 8075 00 04	75	80	447x600x61 h
F DD 8100 00 04	100	100	447x600x86 h
F DD 8125 00 04	125	100	447x600x111 h
F DD 8150 00 04	150	100	447x600x136 h
F DD 8200 00 04	200	100	447x600x186 h
F DD 8250 00 04	250	100	447x600x236 h
F DD 8300 00 04	300	100	447x600x286 h

Normal extension (87%)



■ Drawers cannot be fitted behind doors.

RETRACTABLE SHELF

ORD. NO.	LOAD CAP. kg	USABLE DIMENSIONS mm
F DD 8000 00 04	70	435x610

Normal extension (87%)

■ 01 ■ 02 ■ 04



■ Set of partition material A72



ADJUSTABLE SHELF

ORD. NO.	LOAD CAP. kg	USABLE DIMENSIONS mm
F DD 9100 01 04	70	500x600

Without extension system

■ 01 ■ 02 ■ 04



27 EH (447 mm)



SERIES WORK STANDARD BH

DRAWER CABINETS SERIES F DE (BH) 27x36 EH



ORD. NO.	DRAWERS
F DE 1010 01 04	1
Cabinet with 1 normal extension drawer	
Drawer load capacity: 60 kg	
Dim. mm 565x725x155 h	



ORD. NO.	DRAWERS
F DE 1020 01 04	1
Cabinet with 1 normal extension drawer	
Drawer load capacity: 60 kg	
Dim. mm 565x725x255 h	



ORD. NO.	DRAWERS
F DE 1020 02 04	2
Cabinet with 2 normal extension drawers	
Drawer load capacity: 60 kg	
Dim. mm 565x725x255 h	



ORD. NO.	DRAWERS
F DE 1030 02 04	3
Cabinet with 3 normal extension drawers	
Drawer load capacity: 60 kg	
Dim. mm 565x725x355 h	



ORD. NO.	DRAWERS
F DE 1045 04 04	4
Cabinet with 4 normal extension drawers	
Drawer load capacity: 40 kg	
Dim. mm 565x725x505 h	

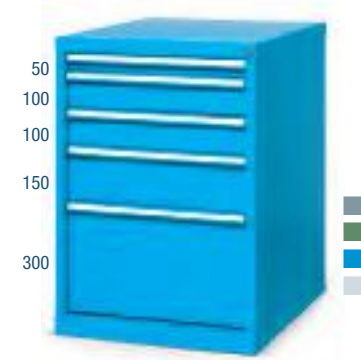

ORD. NO.	DRAWERS
F DE 1070 01 04	5
Cabinet with 5 normal extension drawers	
Drawer load capacity: 60 kg	
Dim. mm 565x725x800 h	

DRAWERS

ORD. NO.	FRONT HEIGHT mm	LOAD CAP. kg	USABLE DIMENSIONS mm
F DE 8050 00 04	50	60	447x600x36 h
F DE 8100 00 04	100	60	447x600x86 h
F DE 8150 00 04	150	60	447x600x136 h
F DE 8200 00 04	200	60	447x600x186 h
F DE 8300 00 04	300	60	447x600x286 h

Normal extension (87%)



EMPTY CABINET

ORD. NO.	USABLE HEIGHT mm	DIMENSIONS mm
F DE 1010 00 04	100	565x725x155 h
F DE 1020 00 04	200	565x725x255 h
F DE 1030 00 04	300	565x725x355 h
F DE 1045 00 04	450	565x725x505 h
F DE 1070 00 04	700	565x725x800 h

■ 01 ■ 02 ■ 04 ■ 08

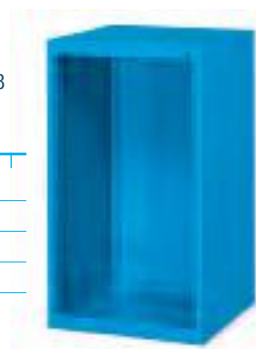

FIXING MATERIAL



ORD. NO. F BL 9011 00 00

RAL 7000 F.01 RAL 6011 F.02 RAL 5012 F.04 RAL 7035 F.08

SUPPLEMENTARY PARTS ■

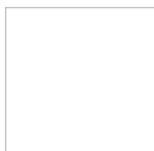
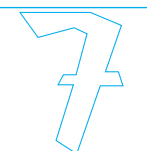

■ All indicated loads are net and refer to evenly distributed weights



■ **Spare key.** Always indicate the number on the cylinder lock of the key to be replaced.
 ORD. NO. R CSC 0002 00
 ■ **Master key.** This type of key opens all the 45 and 46 series locks.
 ORD. NO. R CSC 0001 00



DEPTH = 600 mm (27 Eh)

SERIES WORK-FLEXA

MULTIPLEX WORKTOP 25 mm THICKNESS



WORKTOP DIMENSION mm	ORD. NO.
860x600	F BI 0860 00 00
995x600	F BI 0995 00 00
1150x600	F BI 1150 00 00
1275x600	F BI 1275 00 00
1340x600	F BI 1340 00 00
1420x600	F BI 1420 00 00
1840x600	F BI 1840 00 00

The multiplex worktop includes various layers of beech wood which are planed, glued and pressed together. This makes the worktop non-deformable and load and wear resistant.

LEG

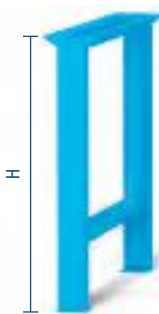

ORD. NO.	DIM. mm
F BL 6024 00 04	80x575x800 h
F BL 6039 00 04	80x575x850 h



■ RAL 5012



■ RAL 5012



■ RAL 7035

■ KEY



■ The FLEXA cabinets can be fixed to the wooden shelves by means of 4 holes on the lid. Ord. no. F BL 9011 00 00 that includes screws and threaded dowels, must be used to fix the cabinet to the shelf.



■ Cabinets see page A2 - A51

RAL 7000 F.01

RAL 6011 F.02

RAL 5012 F.04

RAL 7035 F.08



SERIES WORK-ESA



ORD. NO. F BF 1505 S1 04
RAL 5012

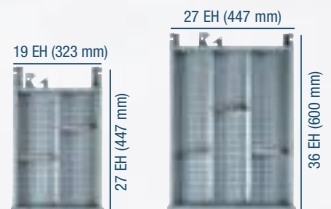

HEXAGONAL WORKSTATION

ORD. NO.

F BF 1505 S1 04

Dimensions mm 2775/2400x850 h

Tools and drawer partitioning sets excluded

POWER TOWER

ORD. NO.

F BF 8145 01 04

Including: 6 multiple socket boxes

1 thermomagnetic switch 2P 230V AC 16A I

Δ N=0,03A

16 Schuko sockets 220-250V 16 A 2P+GND

Dimensions mm 800/922x230 h

Attention: uncabled towers

POWER TOWER

ORD. NO.

F BF 8145 02 04

Including: 6 multiple socket boxes

1 thermomagnetic switch 2P 230V AC 16A I

Δ N=0,03A

11 Schuko sockets 220-250V 16 A 2P+GND

5 heavy-duty sockets 220-250V 16A 2P+GND

Dimensions mm 800/922x230 h

Attention: uncabled towers

RAL 7000 F.01

RAL 6011 F.02

RAL 5012 F.04

RAL 7035 F.08

SUPPLEMENTARY PARTS ■

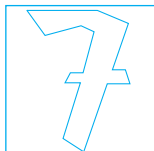

■ Sets of partitions see page A9



■ **Spare key.** Always indicate the number on the cylinder lock of the key to be replaced.

ORD. NO. R CSC 0002 00

■ **Master key.** This type of key opens all the 45 and 46 series locks.

ORD. NO. R CSC 0001 00



LENGTH = 2400/2775 mm (19x27 Eh-27x36 Eh)

SERIES WORK-ESA



1x50
2x100
1x150
1x300

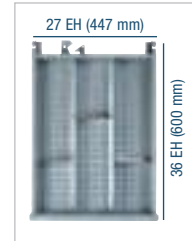

ORD. NO.	TYPE OF WORKTOP	THICKNESS mm	LOAD CAPACITY kg
F BF 1505 01 04	Multiplex	50	1000
F BF 1405 01 04	Multiplex	40	800

Including: 1 multiplex worktop
6 drawer units each with 5 normal extension 27x36 Eh drawers
Dimensions mm 2775/2400

ORD. NO.

F FH 8605 22 00

Set of partitioning material for 27x36 Eh drawer with 50 mm front



1x50
2x100
1x150
1x300

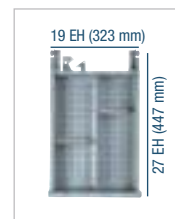

ORD. NO.	TYPE OF WORKTOP	THICKNESS mm	LOAD CAPACITY kg
F BF 1505 03 04	Multiplex	50	1000
F BF 1405 03 04	Multiplex	40	800

Including: 1 multiplex worktop
6 drawer units each with 5 normal extension 19x27 Eh drawers
6 bench wired legs with power fittings each complete with 4 Schuko sockets and thermomagnetic switch 2P 230V AC 10A
Dimensions mm 2775/2400

■ KEY

RAL 7000 F.01 RAL 6011 F.02 RAL 5012 F.04 RAL 7035 F.08



■ All indicated loads are net and refer to evenly distributed weights

■ Sets of partitions see page A9, A72 - A73

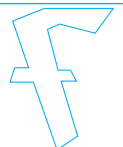

SERIES WORK-ESA



840/850 mm

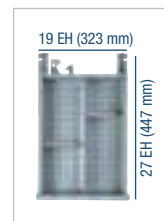

1x50
2x100
1x150
1x300

ORD. NO.	TYPE OF WORKTOP	THICKNESS mm	LOAD CAPACITY kg
F BF 1505 04 04	Multiplex	50	1000
F BF 1405 04 04	Multiplex	40	800

Including: 1 multiplex worktop

6 drawer units each with 5 normal extension 19x27 Eh drawers

6 cabinets each with 120 mm height adjustable steel vices, these rotate and can be recessed into the cabinet. The cabinet is complete with door.

Dimensions mm 2775/2400



Example of the hexagonal workstation with vices recessed inside the cabinet.



ORD. NO.
F FH 8205 04 00
Set of partitioning material for 19x27 Eh drawer with 50 mm front



ORD. NO.
F FH 8215 25 00
Set of partitioning material for 19x27 Eh drawer with 150 mm front

RAL 7000 F.01 RAL 6011 F.02 RAL 5012 F.04 RAL 7035 F.08

KEY ■

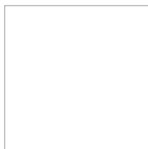
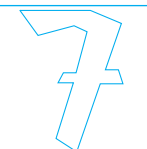

■ Sets of partitions see page A9

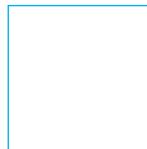

■ All indicated loads are net and refer to evenly distributed weights



LENGTH = 2400/2775 mm (27x27 Eh-27x36 Eh)

SERIES WORK-ESA



- 1x50
- 2x100
- 1x150
- 1x300

ORD. NO.	TYPE OF WORKTOP	THICKNESS mm	LOAD CAPACITY kg
F BF 1505 02 04	Multiplex	50	1000
F BF 1405 02 04	Multiplex	40	800

Including: 1 multiplex worktop

6 drawer units each with 5 normal extension 19x27 Eh drawers

6 bench wired legs with power fittings each complete with 4 Schuko sockets and thermomagnetic switch 2P 230V AC 10A

6 120 mm height adjustable steel vices, these rotate and can be recessed under the wooden worktop.

Dimensions mm 2775/2400

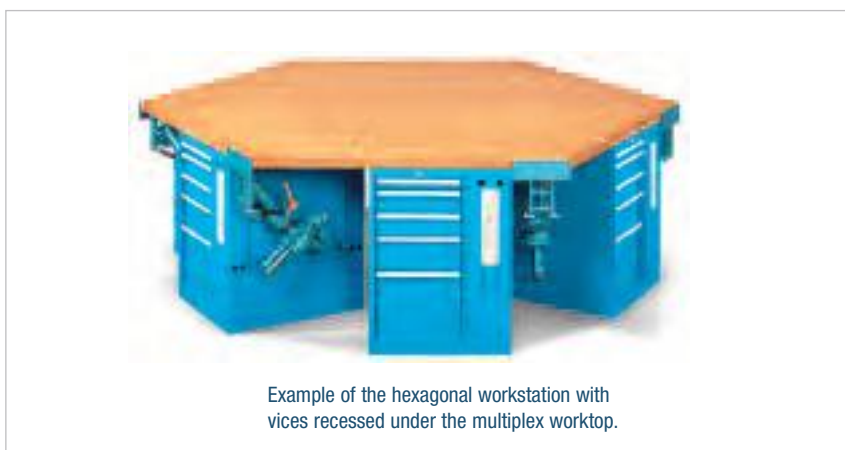

Example of the hexagonal workstation with vices recessed under the multiplex worktop.

KEY

- RAL 7000 F.01
- RAL 6011 F.02
- RAL 5012 F.04
- RAL 7035 F.08



All indicated loads are net and refer to evenly distributed weights

Sets of partitions see page A9

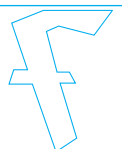

SERIES WORK-SYSTEM 15-75

LENGTH = 1500 mm DEPTH = 750 mm (27x27 Eh)



ORD. NO. F BR 2242 S1 51
RAL 5012+7000



WORKSTATION

ORD. NO.

F BR 2242 S1 51

Dimensions mm 1500x750x865/1500 h

Complete with multi-purpose back panel and vertical drawer

Tools excluded

COMBINATION OF STANDARD COLOURS



■ RAL 6011

■ RAL 5012 +

■ RAL 7000

RAL 5012

RAL 7000 F.51

RAL 6011

RAL 6011 F.02

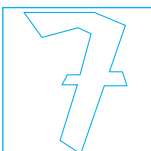

SUPPLEMENTARY PARTS ■

■ **Spare key.** Always indicate the number on the cylinder lock of the key to be replaced.

ORD. NO. R CSC 0002 00

■ **Master key.** This type of key opens all the 45 and 46 series locks.

ORD. NO. R CSC 0001 00



LENGTH = 1500 mm DEPTH = 750 mm (27x27 Eh)

SERIES WORK-SYSTEM 15-75

WORKTOP DIMENSIONS 1500x750x40 mm

ORD. NO.	TYPE OF WORKTOP	THICKNESS mm	LOAD CAPACITY kg
F BR 2242 01 51	Multiplex	40	1000
F BR 1202 01 51	Steel	40	1000



ORD. NO.	TYPE OF WORKTOP	THICKNESS mm	LOAD CAPACITY kg
F BR 2242 03 51	Multiplex	40	1000
F BR 1202 03 51	Steel	40	1000

ORD. NO.	TYPE OF WORKTOP	THICKNESS mm	LOAD CAPACITY kg
F BR 2242 05 51	Multiplex	40	1000
F BR 1202 05 51	Steel	40	1000



ORD. NO.	TYPE OF WORKTOP	THICKNESS mm	LOAD CAPACITY kg
F BR 2242 08 51	Multiplex	40	1000
F BR 1202 08 51	Steel	40	1000

ORD. NO.	TYPE OF WORKTOP	THICKNESS mm	LOAD CAPACITY kg
F BR 2242 S3 51	Multiplex	40	1000
-	Steel	40	1000

KEY



- Worktop dimensions mm 1500x750x40 h
- Unit dimensions mm 1135x630x825 h
- All indicated loads are net and refer to evenly distributed weights

■ Set of partitions see page A19

■ RAL 5012
■ RAL 7000 F. 51 ■ RAL 6011 F. 02



SERIES WORK-SYSTEM 20-75

WORKTOP DIMENSIONS 2000x750x40 mm

ORD. NO.	TYPE OF WORKTOP	THICKNESS mm	LOAD CAPACITY kg
F BR 2243 01 51	Multiplex	40	1000
F BR 1203 01 51	Steel	40	1000

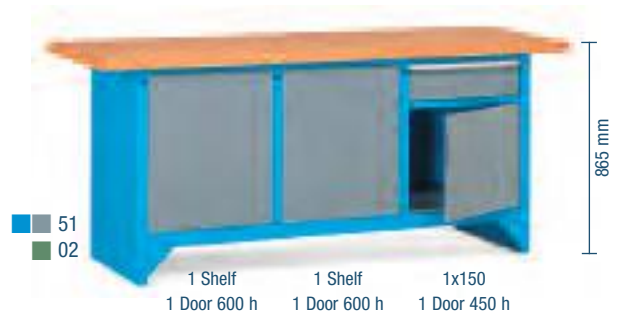
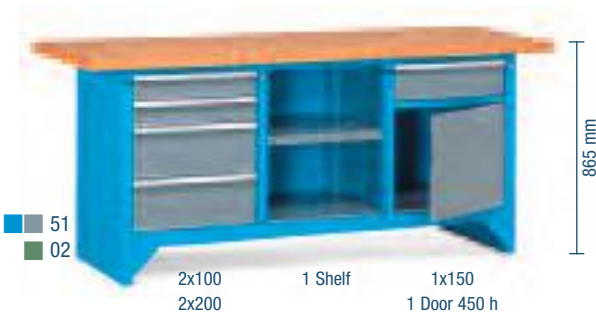
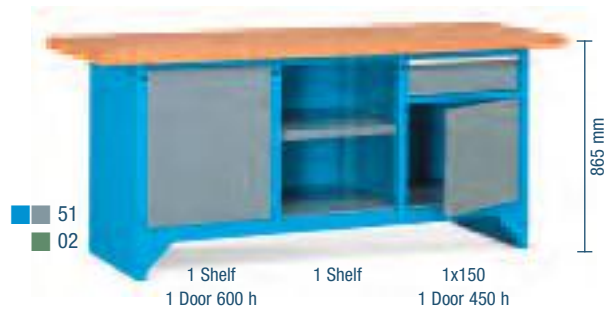

ORD. NO.	TYPE OF WORKTOP	THICKNESS mm	LOAD CAPACITY kg
F BR 2243 02 51	Multiplex	40	1000
F BR 1203 02 51	Steel	40	1000

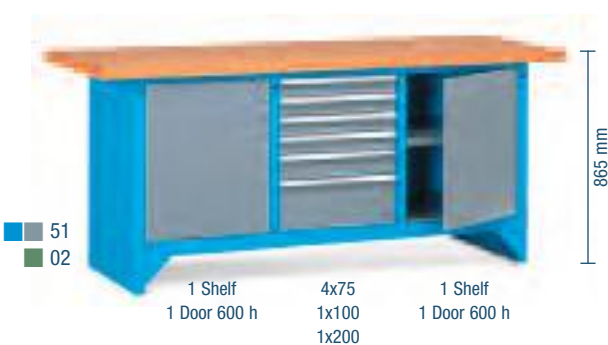

ORD. NO.	TYPE OF WORKTOP	THICKNESS mm	LOAD CAPACITY kg
F BR 2243 03 51	Multiplex	40	1000
F BR 1203 03 51	Steel	40	1000

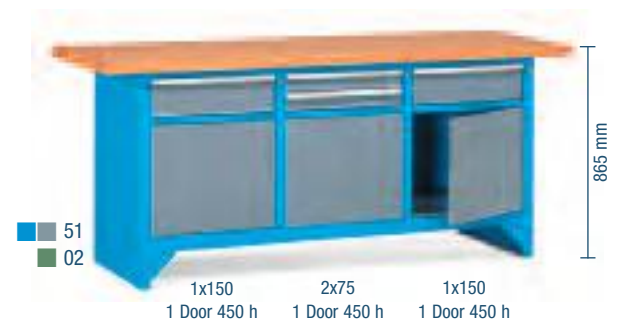

ORD. NO.	TYPE OF WORKTOP	THICKNESS mm	LOAD CAPACITY kg
F BR 2243 05 51	Multiplex	40	1000
F BR 1203 05 51	Steel	40	1000

ORD. NO.	TYPE OF WORKTOP	THICKNESS mm	LOAD CAPACITY kg
F BR 2243 09 51	Multiplex	40	1000
F BR 1203 09 51	Steel	40	1000

RAL 5012 RAL 7000 F... ..51 RAL 6011 F... ..02

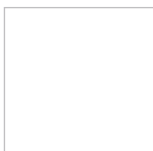
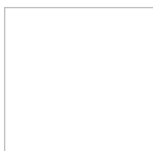
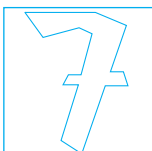

■ Set of partitions see page A19

KEY ■

- Worktop dimensions mm 2000x750x40 h
- Unit dimensions mm 1683x630x825 h
- All indicated loads are net and refer to evenly distributed weights



LENGTH = 2000 mm DEPTH = 750 mm (27x27 Eh)

SERIES WORK-SYSTEM 20-75



■ RAL 5012 +
■ RAL 7000

WORKSTATION

ORD. NO.

F BR 2343 S1 51

Dimensions mm 2000x800x865/1500 h

Equipment excluded

■ INFO



www.famispa.com

■ RAL 5012
■ RAL 7000 F.51 ■ RAL 6011 F.02



SERIES WORK-SYSTEM 25-75

LENGTH = 2500 mm DEPTH = 750 mm (27x27 Eh)

WORKTOP DIMENSIONS 2500x750x40 mm

ORD. NO.	TYPE OF WORKTOP	THICKNESS mm	LOAD CAPACITY kg
F BR 2244 01 51	Multiplex	40	2000

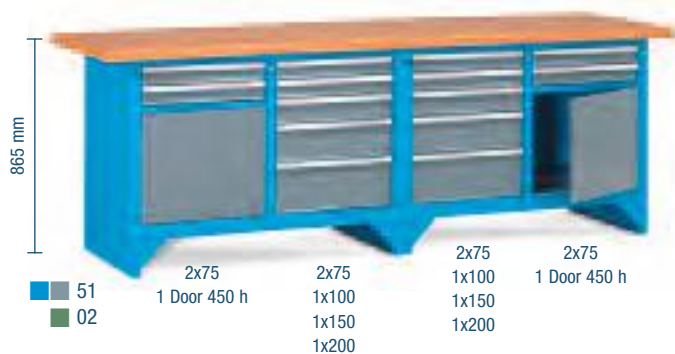
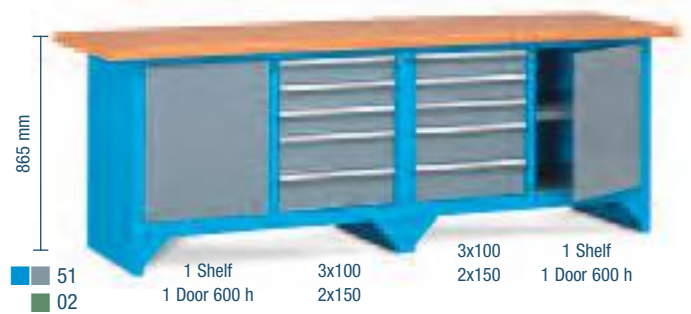

ORD. NO.	TYPE OF WORKTOP	THICKNESS mm	LOAD CAPACITY kg
F BR 2244 02 51	Multiplex	40	2000

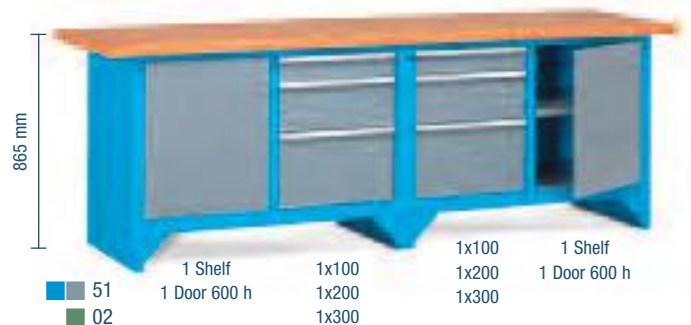

ORD. NO.	TYPE OF WORKTOP	THICKNESS mm	LOAD CAPACITY kg
F BR 2244 03 51	Multiplex	40	2000

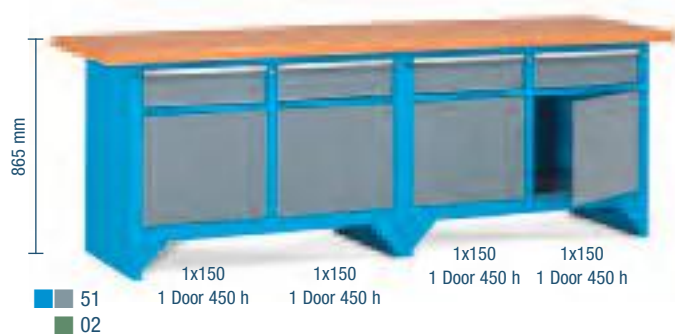

ORD. NO.	TYPE OF WORKTOP	THICKNESS mm	LOAD CAPACITY kg
F BR 2244 04 51	Multiplex	40	2000

RAL 5012 RAL 7000 F.51 RAL 6011 F.02

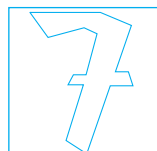

■ Set of partitions see page A19

KEY ■

- Worktop dimensions mm 2500x750x40 h
- Unit dimensions mm 1135x630x825 h + 1135x630x825 h
- All indicated loads are net and refer to evenly distributed weights



LENGTH = 3000 mm DEPTH = 750 mm (27x27 Eh)

SERIES WORK-SYSTEM 30-75

WORKTOP DIMENSIONS 3000x750x40 mm



ORD. NO.	TYPE OF WORKTOP	THICKNESS mm	LOAD CAPACITY kg
F BR 2245 01 51	Multiplex	40	2000

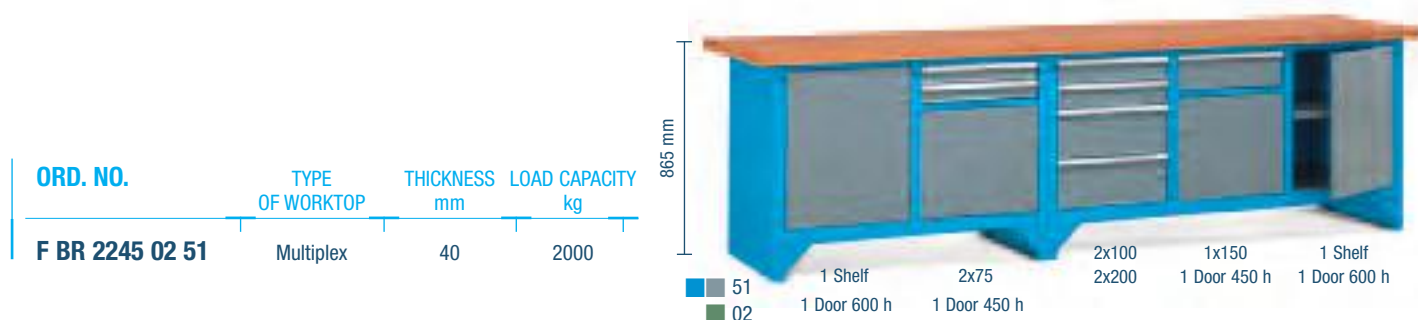

ORD. NO.	TYPE OF WORKTOP	THICKNESS mm	LOAD CAPACITY kg
F BR 2245 02 51	Multiplex	40	2000

WORKSTATION

ORD. NO.

F BR 2245 S1 51

Complete with multi-purpose back panels

Dimensions mm 3000x750x865/2130 h

Tools and sets of partitioning material for drawers excluded



KEY



- Worktop dimensions mm 3000x750x40 h
- Unit dimensions mm 1135x630x825 h + 1683x630x825 h
- All indicated loads are net and refer to evenly distributed weights

Set of partitions see page A19

RAL 5012 RAL 7000 F.51 RAL 6011 F.02



SERIES WORK-SYSTEM

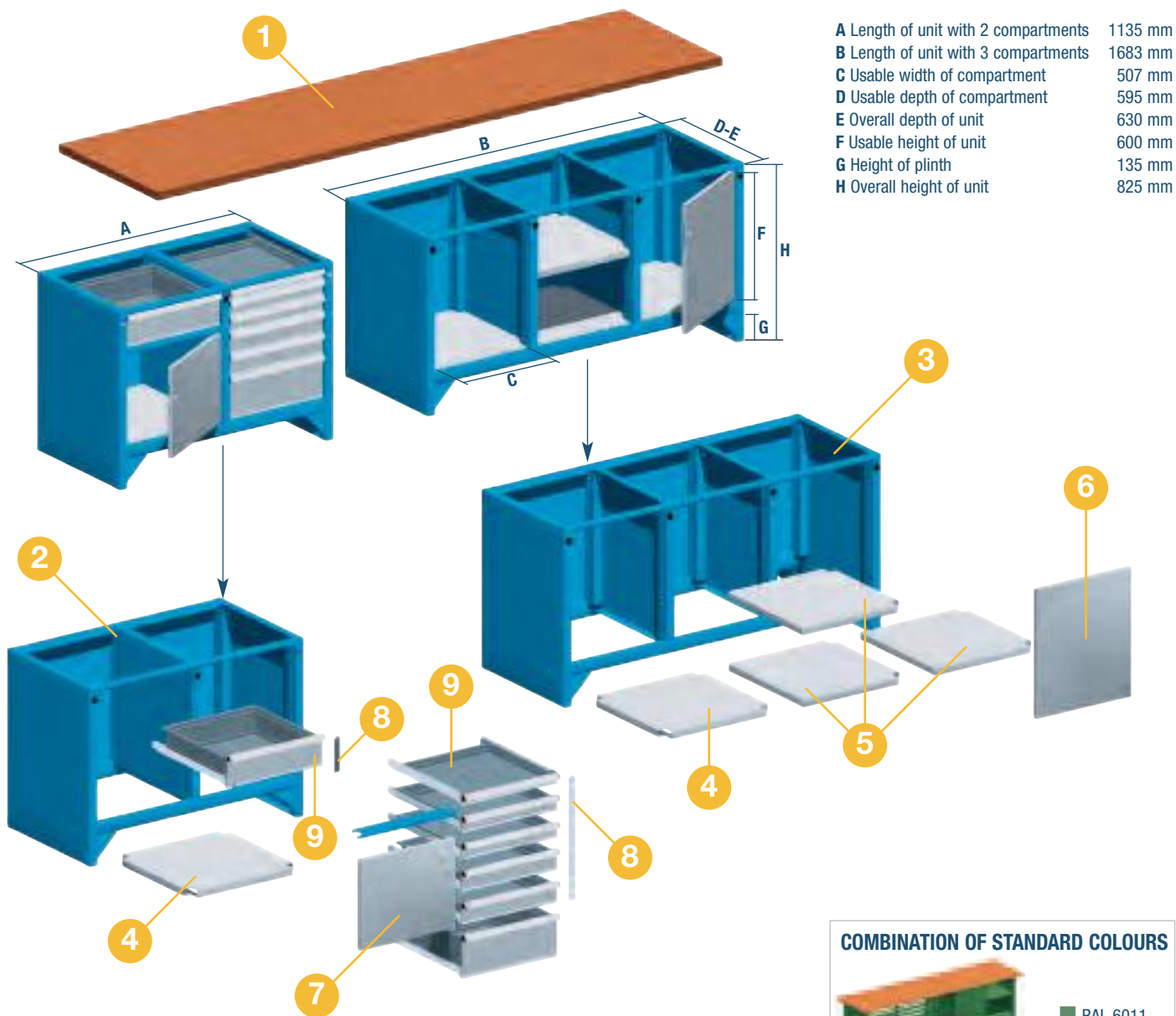

- A Length of unit with 2 compartments 1135 mm
- B Length of unit with 3 compartments 1683 mm
- C Usable width of compartment 507 mm
- D Usable depth of compartment 595 mm
- E Overall depth of unit 630 mm
- F Usable height of unit 600 mm
- G Height of plinth 135 mm
- H Overall height of unit 825 mm

COMBINATION OF STANDARD COLOURS

- RAL 6011
- RAL 5012 +
- RAL 7000

LOAD CAPACITY OF THE WORKTOP OF THE MODULAR WORKSTATIONS

Workstation layout

TYPE OF WORKTOP	THICKNESS mm				
Multiplex	40	1000 kg	1000 kg	2000 kg	2000 kg
Steel	40	1000 kg	1000 kg	-	-

■ RAL 5012
 ■ RAL 7000 F.51 ■ RAL 6011 F.02



KEY ■

■ All indicated loads are net and refer to evenly distributed weights

DEPTH = 630 mm (27x27 Eh)

SERIES WORK-SYSTEM

1 MULTIPLEX SHELF 750 mm DEEP 40 mm THICKNESS

SHELF LENGTH	ORD. NO. MULTIPLEX SHELF	ORD. NO. PRE-DRILLINGS	FOR:
1500	F BI A242 00 00	1 pc F BR 0960 00 00	1 unit with 2 compartments
2000	F BI A270 00 00	1 pc F BR 0961 00 00	1 unit with 3 compartments
2500	F BI A284 00 00	2 pcs F BR 0960 00 00	2 units with 2 compartments
3000	F BI A298 00 00	+ 1 pc F BR 0960 00 00 + 1 pc F BR 0961 00 00	+ 1 unit with 2 compartments + 1 unit with 3 compartments

■ For other wooden worktops see page C2 - C3

1 STEEL SHELF 750 mm DEEP 40 mm THICKNESS

SHELF LENGTH	ORD. NO. MULTIPLEX SHELF	ORD. NO. MULTIPLEX SHELF	ORD. NO. PRE-DRILLINGS	FOR:
1500	■ RAL 7000 F BR 0020 00 01	■ RAL 6011 F BR 0020 00 02	1 pc F BR 0950 00 00	1 unit with 2 compartments
2000	■ RAL 7000 F BR 0030 00 01	■ RAL 6011 F BR 0030 00 02	1 pc F BR 0951 00 00	1 unit with 3 compartments

2 UNIT WITH 2 COMPARTMENTS DIM. mm 1135x630x825 h

ORD. NO.
■ RAL 5012 F BR 2242 00 04
■ RAL 6011 F BR 2242 00 02

3 UNIT WITH 3 COMPARTMENTS DIM. mm 1683x630x825 h

ORD. NO.
■ RAL 5012 F BR 2243 00 04
■ RAL 6011 F BR 2243 00 02

4 LEFT-HAND STEEL SHELVES
DIMENSIONS mm 579x566x35 h

ORD. NO.
■ RAL 7000 F BR 0220 01 01
■ RAL 6011 F BR 0220 01 02

This shelf is used as a bottom or an adjustable shelf for the **left-hand compartments of each unit**

Shelf load capacity: 50 kg

5 CENTRAL OR RIGHT-HAND STEEL SHELVES
DIMENSIONS mm 543x566x35 h

ORD. NO.
■ RAL 7000 F BR 0230 01 01
■ RAL 6011 F BR 0230 01 02

This shelf is used as a bottom or an adjustable shelf for the **central or the right-hand compartments of each unit**

Shelf load capacity: 50 kg

6 DOORS DIMENSIONS mm 504x598 h

ORD. NO. right door	ORD. NO. left door
■ RAL 7000 F BR 0720 00 01	■ RAL 7000 F BR 0721 00 01
■ RAL 6011 F BR 0720 00 02	■ RAL 6011 F BR 0721 00 02

This door is available with right and left-hand openings. It is **600 mm** high and completely covers a compartment. Supplied standard with cylinder lock and two keys.

7 DOORS DIMENSIONS mm 504x420 h

ORD. NO. right door	ORD. NO. left door
■ RAL 7000 F BR 0710 00 51	■ RAL 7000 F BR 0711 00 51
■ RAL 6011 F BR 0710 00 02	■ RAL 6011 F BR 0711 00 02

This door is available with right and left-hand openings. It partially covers a compartment up to a height of 450 mm. A shelf or drawers must be fitted over the door. Supplied standard with cylinder lock and two keys.

8 150 – 600 mm HIGH LOCKING BARS FOR DRAWERS

ORD. NO. length 150 mm	ORD. NO. length 600 mm
F BR 0410 00 00	F BR 0430 00 00

These locking systems include a 150 mm or 600 mm locking bar and a cylinder lock with two keys.

9 DRAWERS

ORD. NO.	FRONT HEIGHT mm	LOAD CAPACITY kg	USABLE DIMENSIONS mm
F DB 8050 00 04	50	50	447x447x36 h
F DB 8075 00 04	75	70	447x447x61 h
F DB 8100 00 04	100	70	447x447x86 h
F DB 8125 00 04	125	70	447x447x111 h
F DB 8150 00 04	150	70	447x447x136 h
F DB 8200 00 04	200	70	447x447x186 h
F DB 8250 00 04	250	70	447x447x236 h
F DB 8300 00 04	300	70	447x447x286 h

Extension 100%



■ 01
■ 02
■ 04
■ 08

SERIES WORK-LOOK 10



ORD. NO. F BH A328 S3 04
RAL 5012

WORKSTATION

ORD. NO.

F BH A328 S3 04

Dimensions mm 1300x800x840/2110 h

Tools, boxes and electrical equipment excluded

RAL 7000 F.01

RAL 6011 F.02

RAL 5012 F.04

RAL 7035 F.08

INFO ■

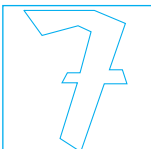

■ Set of hooks
see page C66

www.famispa.com



LENGTH = 1000 mm

SERIES WORK-LOOK 10

ORD. NO. BACK PANEL FOR

F BL A010 03 04 Wood

- 2 support columns 632 mm h
 - 2 perforated back panels 972x304 mm h
- Tools, hooks and boxes excluded

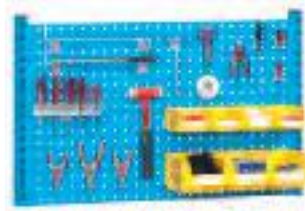

ORD. NO. BACK PANEL FOR

F BL A110 05 04 Wood

- 2 support columns 632 mm h, 1 shelf 955x220 mm
 - 1 perforated back panel 972x304 mm h
 - 1 multiple socket box with cabling complete with 5 Schuko sockets and thermomagnetic switch 2P 230V AC 10A I Δ N=0,01A
 - 1 swivel arm with two joints complete with practibox
- Tools, hooks and boxes excluded

ORD. NO. BACK PANEL FOR

F BL A010 04 04 Wood

- 2 support columns 936 mm
 - 3 perforated back panels 972x304 mm
- Tools, hooks and boxes excluded



ORD. NO. BACK PANEL FOR

F BL A110 09 04 Wood

- 2 support columns 1240 mm h, 1 shelf 955x220 mm
 - 1 shelf 955x320 mm, 1 perforated back panel 972x304 mm h
 - 1 pair of carrier arms with aluminium slide track
 - 1 additional aluminium slide track, 1 2x18W Philips lamp
 - 1 pneumatic system
 - 1 multiple socket box with cabling complete with 5 Schuko sockets and thermomagnetic switch 2P 230V AC 10A I Δ N=0,01A
- Tools and boxes excluded



ORD. NO. BACK PANEL FOR

F BL A110 10 04 Wood

- 2 support columns 1240 mm h, 1 plain back panel 972x304 mm h
 - 2 shelves 955x420 mm
 - 1 pair of carrier arms with aluminium slide track
 - 1 2x36W Waldmann lamp
 - 1 multiple socket box with cabling complete with 5 Schuko sockets and thermomagnetic switch 2P 230V AC 10A I Δ N=0,01A
 - 1 monitor arm load capacity 13 kg
- Tools excluded

■ INFO

RAL 7000 F.01 RAL 6011 F.02 RAL 5012 F.04 RAL 7035 F.08



www.famispa.com



■ Set of hooks
see page C66

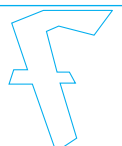

SERIES WORK-LOOK 15



ORD. NO. F BH A342 S2 04
RAL 5012

WORKSTATION

ORD. NO.

F BH A342 S2 04

Dim. mm 1500x800x840/2110 h

Tools and drawer partitioning set
excluded

RAL 7000 F.01

RAL 6011 F.02

RAL 5012 F.04

RAL 7035 F.08

INFO ■

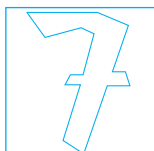

■ Set of hooks
see page C66

www.famispa.com



LENGTH = 1500 mm

SERIES WORK-LOOK 15

ORD. NO. BACK PANEL FOR

F BL A015 01 07 Wood
 2 height-adjustable shelves brackets 215-335 mm h
 1 shelf of multiplex 1500x300x20 mm h
 Tools and boxes excluded



ORD. NO. BACK PANEL FOR

F BL A015 06 04 Wood
F BL B015 06 04 Steel
 2 support columns 632 mm h
 2 perforated back panels 1457x304 mm h
 Tools, hooks and boxes excluded

ORD. NO. BACK PANEL FOR

F BL A015 07 04 Wood
 2 support columns 936 mm h
 3 perforated back panels 1457x304 mm h
 Tools, hooks and boxes excluded

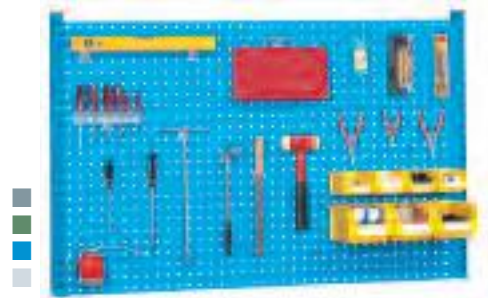

ORD. NO. BACK PANEL FOR

F BL A115 09 04 Wood
 2 support columns 1240 mm h, 1 shelf 1440x320 mm
 1 plain back panel 1457x304 mm h
 1 pair of carrier arms with aluminium slide track
 1 power panelling with cabling complete with 9 Schuko sockets and thermomagnetic switch 2P 230V AC 10A | Δ N=0,01A
 1 pair of supports for rear power panelling
 2 230V winders with 10 metres of cable 3x1,5 mm²
 1 heavy duty flying socket 220-250 V 16A 2P+GND and
 1 Schuko socket 220-250V 16A 2P+GND
 1 2x36W Philips lamp
 Tools excluded



ORD. NO. BACK PANEL FOR

F BL A115 14 04 Wood
 2 support columns 1240 mm h
 1 shelf 1440x320 mm
 1 perforated back panel 1457x304 mm h
 1 pair of carrier arms with aluminium slide track
 1 additional aluminium slide track
 1 2x36W Philips lamp
 1 pneumatic system
 1 multiple socket box with cabling complete with 5 Schuko sockets and thermomagnetic switch 2P 230V AC 10A | Δ N=0,01A
 1 swivel arm with two joints complete with practibox
 Tools, hooks and boxes excluded

INFO

RAL 7000 F.01 RAL 6011 F.02 RAL 5012 F.04 RAL 7035 F.08



www.famispa.com



■ Set of hooks
 see page C66

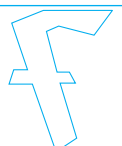

SERIES WORK-LOOK 20

LENGTH = 2000 mm



RAL 7000 F.01

RAL 6011 F.02

RAL 5012 F.04

RAL 7035 F.08

INFO ■

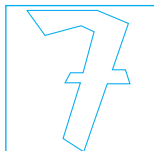

■ Set of hooks
see page C66

www.famispa.com



LENGTH = 2000 mm

SERIES WORK-LOOK 20

ORD. NO. BACK PANEL FOR

F BL A020 01 07 Wood
 2 height-adjustable shelves brackets 215-335 mm h
 1 shelf in multiplex 2000x300x20 mm h
 Tools and boxes excluded

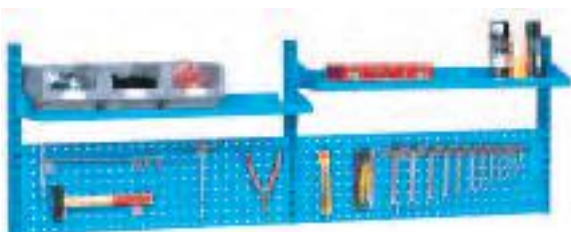

ORD. NO. BACK PANEL FOR

F BL A020 05 04 Wood
F BL B020 05 04 Steel
 3 support columns 632 mm h, 2 shelves 955x320 mm
 2 perforated back panels 972x304 mm h
 Tools, hooks and boxes excluded

ORD. NO. BACK PANEL FOR

F BL A020 07 04 Wood
F BL B020 07 04 Steel
 3 support columns 632 mm h
 4 perforated back panels 972x304 mm h
 Tools and hooks excluded



ORD. NO. BACK PANEL FOR

F BL A120 20 04 Wood
 3 support columns 1240 mm h
 5 perforated back panels 972x304 mm h
 1 carrier arm assembly with aluminium slide track
 1 roller shutter cabinet
 1 multiple socket box with cabling complete with 5 Schuko sockets and thermomagnetic switch 2P 230V AC 10A I Δ N=0,01A
 1 2x36W Philips lamp
 Tools, hooks and boxes excluded

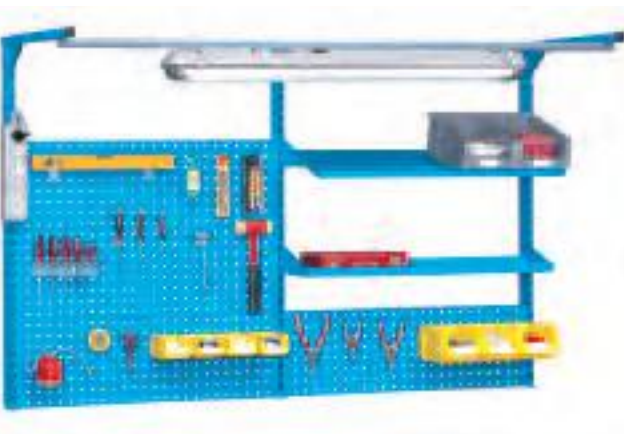

ORD. NO. BACK PANEL FOR

F BL A120 13 04 Wood
 3 support columns 1240 mm h
 1 shelf 955x220 mm, 1 shelf 955x320 mm
 4 perforated back panels 972x304 mm h
 1 carrier arm assembly with aluminium slide track
 1 2x36W Philips lamp
 1 multiple socket box with cabling complete with 5 Schuko sockets and thermomagnetic switch 2P 230V AC 10A I Δ N=0,01A
 Tools, hooks and boxes excluded

INFO



www.famispa.com

RAL 7000 F.01 RAL 6011 F.02 RAL 5012 F.04 RAL 7035 F.08



■ Set of hooks see page C66

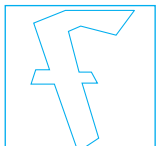

SERIES WORK-LOOK 25



ORD. NO. F BK A584 S1 04
RAL 5012

WORKSTATION

ORD. NO.

F BK A584 S1 04

Dimensions mm 2500x800x850/2120 h

Tools excluded

RAL 7000 F.01

RAL 6011 F.02

RAL 5012 F.04

RAL 7035 F.08

INFO ■

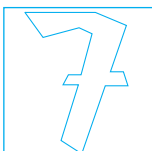

■ Set of hooks
see page C66

www.famispa.com



LENGTH = 2500

SERIES WORK-LOOK 25

ORD. NO.

BACK PANEL FOR

F BL A025 02 07

Wood

3 height-adjustable shelves brackets 215-335 mm h

1 shelf in multiplex 2500x300x20 mm h

Tools and boxes excluded



ORD. NO.

BACK PANEL FOR

F BL A025 06 04

Wood

3 support columns 632 mm h

1 shelf 1440x220 mm

1 shelf 955x220 mm

1 perforated back panel 972x304 mm h

1 perforated back panel 1457x304 mm h

Tools, hooks and boxes excluded

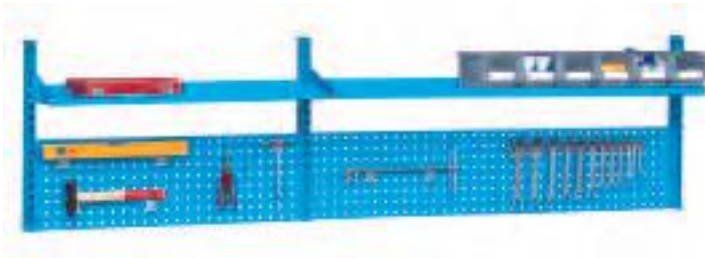

ORD. NO.

BACK PANEL FOR

F BL A025 08 04

Wood

3 support columns 936 mm h

3 perforated back panels 972x304 mm h

3 perforated back panels 1457x304 mm h

Tools, hooks and boxes excluded



ORD. NO.

BACK PANEL FOR

F BL A025 08 04

Wood

3 support columns 936 mm h

3 perforated back panels 972x304 mm h

3 perforated back panels 1457x304 mm h

Tools, hooks and boxes excluded



ORD. NO.

BACK PANEL FOR

F BL A125 11 04

Wood

3 support columns 1240 mm h

1 shelf 1440x320 mm

1 shelf 955x320 mm

1 shelf 1440x220 mm

2 perforated back panels 972x304 mm h

1 perforated back panel 1457x304 mm h

1 carrier arm assembly with aluminium slide track

1 2x36W Philips lamp

1 multiple socket box with cabling complete with 5 Schuko sockets and thermomagnetic switch 2P 230V AC 10A I Δ N=0,01A

Tools, hooks and boxes excluded

■ INFO

RAL 7000 F.01 RAL 6011 F.02 RAL 5012 F.04 RAL 7035 F.08



■ Set of hooks
see page C66

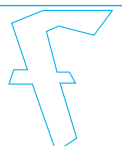

www.famispa.com



ORD. NO. F BI A598 S2 04
RAL 5012

WORKSTATION

ORD. NO.

F BI A598 S2 04

Dimensions mm 3000x800x850/2120 h

Tools excluded

RAL 7000 F.01

RAL 6011 F.02

RAL 5012 F.04

RAL 7035 F.08

INFO ■

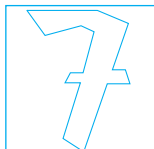

■ Set of hooks
see page C66

www.famispa.com



LENGTH = 3000 mm

SERIES WORK-LOOK 30

ORD. NO. BACK PANEL FOR

F BL A030 02 07 Wood
 3 height-adjustable shelves brackets 215-335 mm h
 1 shelf of multiplex 3000x300x20 mm h

Tools and boxes excluded



ORD. NO. BACK PANEL FOR

F BL A030 03 04 Wood
 3 support columns 632 mm h
 2 shelves 1440x220 mm
 2 shelves 1440x320 mm

Tools, hooks and boxes excluded



ORD. NO. BACK PANEL FOR

F BL A030 07 04 Wood
 3 support columns 632 mm h
 4 perforated back panels 1457x304 mm h

Tools, hooks and boxes excluded



ORD. NO. BACK PANEL FOR

F BL A130 11 04 Wood
 3 support columns 1240 mm h
 3 perforated back panels 1457x304 mm h
 2 shelves 1440x320 mm h
 1 carrier arm assembly with aluminium slide track
 1 2x36W Philips lamp
 1 pair of supports for rear power panelling
 1 power panelling with cabling complete with 9 Schuko sockets and thermomagnetic switch 2P 230V AC 10A I Δ N=0,001A

Tools, hooks and boxes excluded



■ INFO

RAL 7000 F.01 RAL 6011 F.02 RAL 5012 F.04 RAL 7035 F.08



www.famispa.com



■ Set of hooks
see page C66



SERIES WORK-LOOK

SET OF SUPPORT COLUMNS WITH BOTH SIDE DUAL SLOTS
FOR STEEL WORKTOPS LENGTH 1500 MM

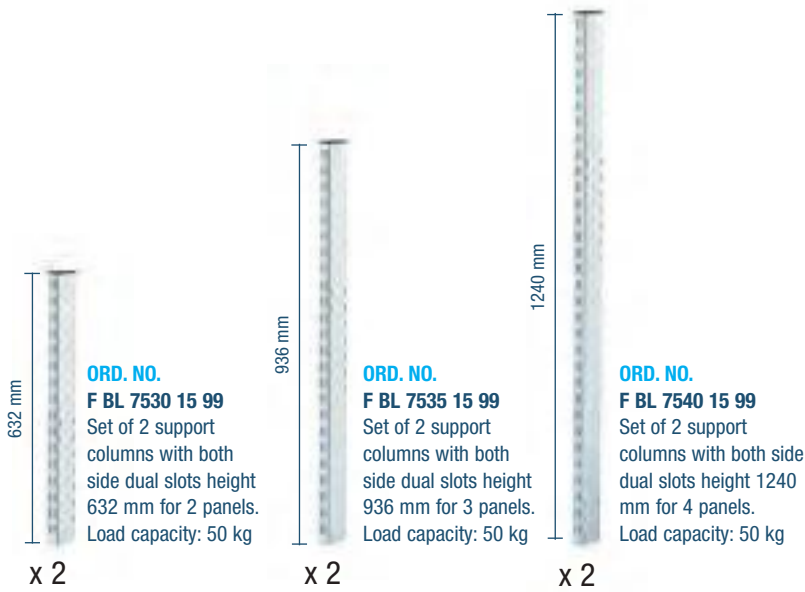

■ 01 ■ 02 ■ 04 ■ 08 ■ 99

SUPPORT COLUMNS WITH BOTH SIDE
DUAL SLOTS FOR WOODEN WORKTOPS

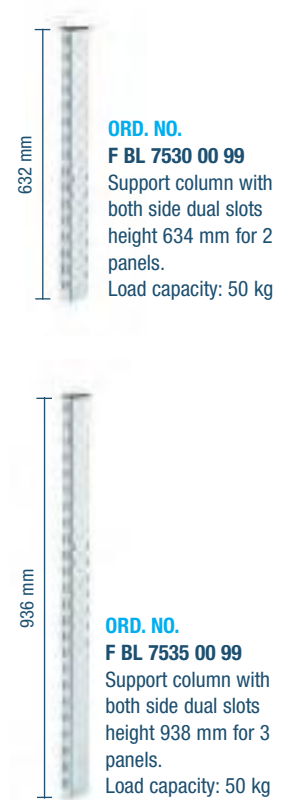

SET OF SUPPORT COLUMNS WITH BOTH SIDE DUAL SLOTS
FOR STEEL WORKTOPS LENGTH 2000 MM

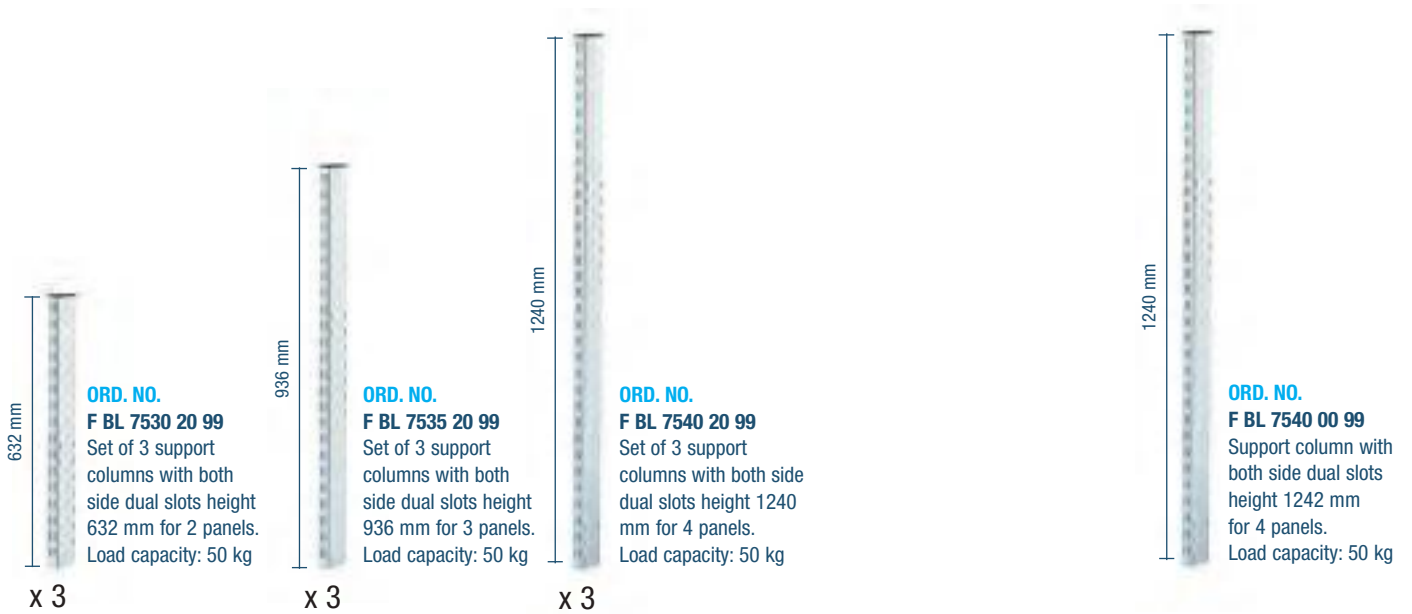

■ 01 ■ 02 ■ 04 ■ 08 ■ 99

■ 01 ■ 02 ■ 04 ■ 08 ■ 99

RAL 7000 F.01 RAL 6011 F.02 RAL 5012 F.04 RAL 7035 F.08

KEY ■



■ All indicated loads are net and refer to evenly distributed weights

SHELF FOR MULTI-PURPOSE PANELS LENGTH 1000 mm



Height-adjustable tilting shelf in 2 positions with front or rear upstand

available in 3 dimensions:

955x220 mm 955x320 mm 955x420 mm

ORD. NO.	DEPTH OF SHELF mm	LOAD CAPACITY kg
F BL 7750 00 04	220	25
F BL 7755 00 04	320	25
F BL 7760 00 04	420	25
F BL 7762 00 04	600	25

■ 01 ■ 02 ■ 04 ■ 08 ■ 99

SHELF FOR MULTI-PURPOSE PANELS LENGTH 1500 mm



Height-adjustable tilting shelf in 2 positions with front or rear upstand

available in 3 dimensions:

1440x220 mm 1440x320 mm 1440x420 mm

ORD. NO.	DEPTH OF SHELF mm	LOAD CAPACITY kg
F BL 7795 00 04	220	25
F BL 7800 00 04	320	25
F BL 7805 00 04	420	25

■ 01 ■ 02 ■ 04 ■ 08 ■ 99

PERFORATED PANEL

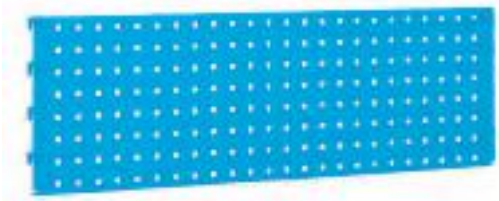

Perforated panel equipped for fixing the support columns with both side dual slots, available in two sizes:

973x304 mm h for length 1000 mm
1458x304 mm h for length 1500 mm

ORD. NO.	LENGTH OF PANEL mm	LOAD CAPACITY kg
F BL 7620 00 04	973	25
F BL 7635 00 04	1458	25

■ 01 ■ 02 ■ 04 ■ 08

PLAIN PANEL



Plain panel equipped for fixing the support columns with both side dual slots, available in two sizes:

973x304 mm h for length 1000 mm
1458x304 mm h for length 1500 mm

ORD. NO.	LENGTH OF PANEL mm
F BL 7670 00 04	973
F BL 7685 00 04	1458

■ 01 ■ 02 ■ 04 ■ 08

■ KEY

■ RAL 7000 F.01 ■ RAL 6011 F.02 ■ RAL 5012 F.04 ■ RAL 7035 F.08



■ All indicated loads are net and refer to evenly distributed weights



■ Set of hooks
see page C66

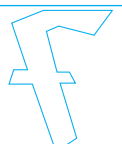

SERIES WORK-LOOK

PAIR OF CARRIER ARMS WITH ALUMINIUM SLIDE TRACK LENGTH 1000/1500 mm

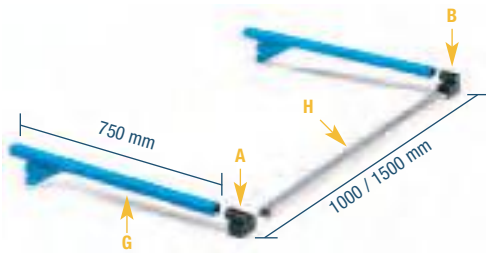

Pair of carrier arms with slide track depth **750 mm** for length **1000-1500 mm**. Includes 2 carrier arms (ref. G), 1 pair of plastic end connectors (ref. A+B) and 1 aluminium track (ref. H).

ORD. NO.	LENGTH OF SLIDE TRACK mm	LOAD CAPACITY kg
F BL 9810 01 54	1000	10
F BL 9815 01 54	1500	10

■ RAL 7000 + Aluminium F.52 ■ RAL 5012 + Aluminium F.54
■ RAL 6011 + Aluminium F.53 ■ RAL 7035 + Aluminium F.55

CARRIER ARMS ASSEMBLY WITH ALUMINIUM SLIDE TRACK LENGTH 2000/2500/3000 mm

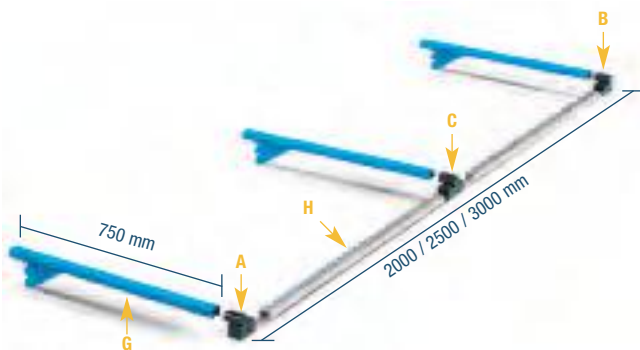

Carrier arms assembly with slide track depth **750 mm** for length **2000-2500-3000 mm**. Includes 3 carrier arms (ref. G), 1 pair of plastic end connectors (ref. A+B), 1 plastic junction connector (ref. C) and 2 aluminium tracks (ref. H).

ORD. NO.	LENGTH OF SLIDE TRACK mm	LOAD CAPACITY kg
F BL 9820 01 54	2000	10
F BL 9825 01 54	2500	10
F BL 9830 01 54	3000	10

■ RAL 7000 + Aluminium F.52 ■ RAL 5012 + Aluminium F.54
■ RAL 6011 + Aluminium F.53 ■ RAL 7035 + Aluminium F.55



■ RAL 7035

WORKSTATION

ORD. NO.

F BH A370 S2 08

Dimensions mm 2000x800x840/2110 h

Tools and boxes excluded

CARRIER ARMS ASSEMBLY WITH ALUMINIUM SLIDE TRACK LENGTH 3000 mm

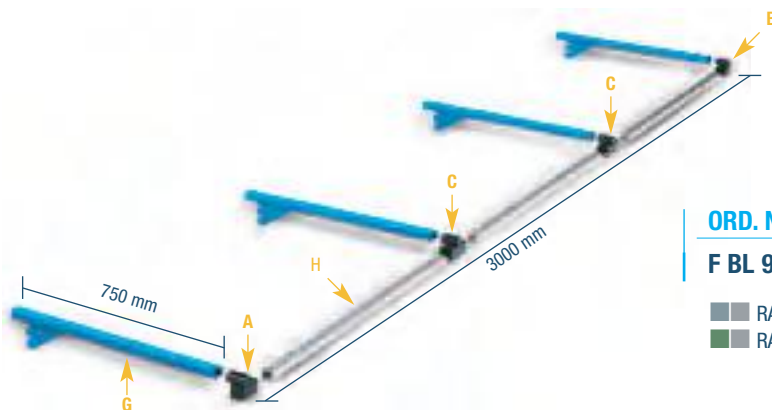

Carrier arms assembly with slide track depth **750 mm** for length **3000 mm**. Includes 4 carrier arms (ref. G), 1 pair of plastic end connectors (ref. A+B), 2 plastic junction connectors (ref. C) and 3 aluminium tracks (ref. H).

ORD. NO.	LENGTH OF SLIDE TRACK mm	LOAD CAPACITY kg
F BL 9830 02 54	3000	10

■ RAL 7000 + Aluminium F.52 ■ RAL 5012 + Aluminium F.54
■ RAL 6011 + Aluminium F.53 ■ RAL 7035 + Aluminium F.55

ADDITIONAL ALUMINIUM SLIDE TRACK WITH CONNECTORS

Additional aluminium slide track with connectors.
The slide tracks with length 2000-2500- 3000
are supplied in various sections.



ORD. NO.	LENGTH OF SLIDE TRACK mm
F BL 9810 10 00	1020
F BL 9815 10 00	1500
F BL 9820 10 00	2000
F BL 9825 10 00	2500
F BL 9830 10 00	3000*
F BL 9830 11 00	3000**

*additional alumin. slide track for assembly with 3 supports
**additional alumin. slide track for assembly with 4 supports

CONNECTORS

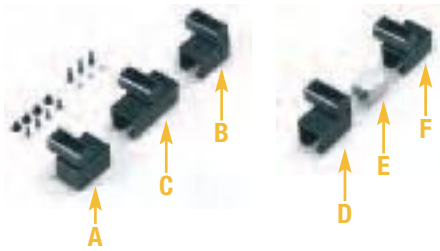

ORD. NO.	REFERENCE
F BL 9841 00 07	A+B
F BL 9840 00 07	C
F BL 9842 00 07	D+E+F

The set of connectors (ref. D+E+F) is used when the tracks of several workstations have to be joined together for the transit of the trolley. The slide track (ref. E) is 60 mm in length.

ROLLER SHUTTER CABINET



ORD. NO.	FIXING TYPE	CYLINDER LOCK	LOAD CAPACITY kg
F BL 7011 01 51	to the wall	series 45	50
F BL 7011 02 51	to the support columns	series 45	50
F BL 7011 03 51	to the wooden worktops	series 45	50
Overall dimensions mm 952x210x810 h			
Usable dimensions mm 905x150x581 h			
Hooks and tools excluded			
■ 01 ■ 02 ■ 51 ■ 56			



ORD. NO.	FIXING TYPE	CYLINDER LOCK	LOAD CAPACITY kg
F BL 7021 01 51	to the wall	series 45	50
F BL 7021 03 51	to the wooden worktops	series 45	50
Overall dimensions mm 952x210x1115 h			
Usable dimensions mm 905x150x885 h			
Hooks and tools excluded			
■ 01 ■ 02 ■ 51 ■ 56			

WINDER



ORD. NO. F BL 9601 01 07

IP42 230V winder with 10 metres of cable
3x1,5 mm² complete with a heavy duty flying socket
220-250V 16A 2P+GND and a Schuko socket 220-250V
10A 2P+GND. The winder is fitted with a bracket for
connection to the support columns with dual slots.

Power output:
with cable wound up 1200W
with cable unwound 1800W



SERIES WORK-LOOK

PHILIPS LAMP IP 66

Structure: Casing in polyester, cover in transparent polycarbonate

■ 08



ORD. NO.	DIMENSIONS mm
F BL 9905 00 00	700x140x85 h
Fixing material included	

Technical specifications of lamp:

Protected to:	IP 66	Length of cable:	4 metres
Neon:	2x18W	Tonality:	4000K
Electrical input:	230V/50Hz	Colour rendering (Ra):	80-89
Plug:	Schuko		

Structure: Casing in polyester, cover in transparent polycarbonate

■ 08



ORD. NO.	DIMENSIONS mm
F BL 9910 00 00	1300x165x95 h
Fixing material included	

Technical specifications of lamp:

Protected to:	IP 66	Length of cable:	4 metres
Neon:	2x36W	Tonality:	4000K
Electrical input:	230V/50Hz	Colour rendering (Ra):	80-89
Plug:	Schuko		

Structure: Casing in polyester, cover in transparent polycarbonate

■ 08



ORD. NO.	DIMENSIONS mm
F BL 9915 00 00	1600x165x95 h
Fixing material included	

Technical specifications of lamp:

Protected to:	IP 66	Length of cable:	4 metres
Neon:	2x58W	Tonality:	4000K
Electrical input:	230V/50Hz	Colour rendering (Ra):	80-89
Plug:	Schuko		

ANTI-GLARE HOOD FOR PHILIPS LAMP

■ 08



ORD. NO.	FOR LAMP
F BL 9921 00 08	2x18 W
F BL 9922 00 08	2x36 W

WALDMANN LAMP 2x36 W IP 67

Structure: Glass tube, parabolic diffuser



ORD. NO.	DIAMETER mm	LENGTH mm
F BL 9960 00 00	70	1090
Fixing material included		

Technical specifications of lamp:

Protected to:	IP 67	Length of cable:	4 m
Neon:	2x36W	Tonality:	4000K
Electrical input:	230V/50Hz	Colour rendering (Ra):	80-89
Plug:	Schuko		

WALDMANN LAMP 2x36 W IP 20

Structure: Casing in aluminium, metallic parabolic diffuser

■ 08

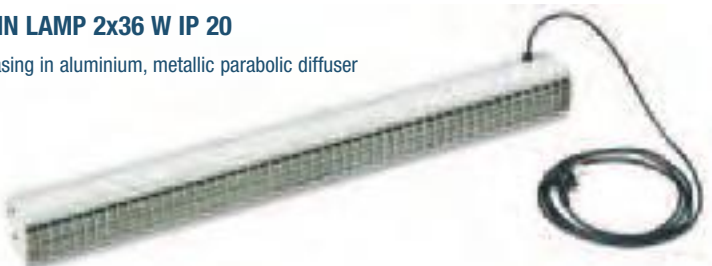

ORD. NO.	DIMENSIONS mm
F BL 9930 00 08	910x90x105 h
Fixing material included	

Technical specifications of lamp:

Protected to:	IP 20	Length of cable:	2,95 m
Neon:	2x36W	Tonality:	4000K
Electrical input:	230V/50Hz	Colour rendering (Ra):	80-89
Plug:	Schuko		



■ RAL 5012

WORKSTATION

ORD. NO.

F BI A528 S3 04

Dimensions mm 1300x800x850/2120 h

Tools and boxes excluded

TRIPLE-JOINTED WALDMANN LAMP 1x36 W IP 20

Structure: Casing in aluminium, metallic parabolic diffuser

■ 08

ORD. NO. F BL 9980 00 08

The standard lighting system includes:

1 multi-purpose steel support for fixing the lamp

1 clamp 0–65 mm

1 triple-jointed lamp

Technical specifications of lamp:

Protected to:	IP 20	Length of cable:	1,95 m
Neon:	1x36W	Tonality:	4000K
Electrical input:	230V/50Hz	Colour rendering (Ra):	80-89
Plug:	Schuko		

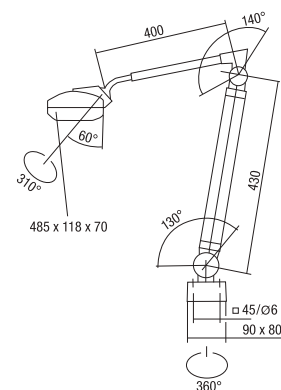

The multi-purpose steel support (supplied standard with the lamp) is used to fix the lamp to the support column with dual slots.



■ RAL 5012

WORKSTATION

ORD. NO. F BH A328 S3 04

Dimensions mm 1300x800x840/2110 h

Tools, boxes and electrical equipment excluded



■ RAL 5012

WORKSTATION

ORD. NO. F BH A342 S2 04

Dimensions mm 1500x800x840/2110 h

Tools and sets of partitioning material for drawers excluded



SWIVEL ARM WITH TWO JOINTS WITH INCLINED TRAY

ORD. NO.

F BL 7456 00 08

Complete with screw brakes with knob

Internal dim. of tray 401x402x21 mm h



SWIVEL ARM WITH TWO JOINTS WITH BOXES

ORD. NO.

F BL 7445 03 08

Complete with 5 grey boxes size 1 and
3 grey boxes size 2

Load capacity 15 kg



SWIVEL ARM WITH TWO JOINTS WITH BOXES

ORD. NO.

F BL 7445 04 08

Complete with 15 grey boxes size 1

Load capacity 15 kg



SWIVEL ARM WITH TWO JOINTS WITH TRAY

ORD. NO.

F BL 7455 00 08

Complete with screw brakes with knob

Load capacity 20 kg



SWIVEL ARM WITH TWO JOINTS WITH PRACTIBOX

ORD. NO.

F BL 7446 01 08

Complete with 1 practibox drawer unit with 9 drawers and
2 practibox drawer units with 6 drawers

Load capacity 15 kg

RAL 7000 F.01 RAL 6011 F.02 RAL 5012 F.04 RAL 7035 F.08

KEY ■

■ All indicated loads are net and refer to evenly distributed weights

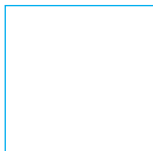
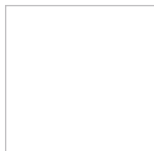
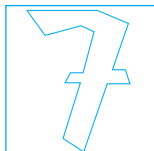



■ Power panelling see page D74



■ Multiple socket box see page D75



■ Pneumatic system see page D71

■ INFO



www.famispaspa.com

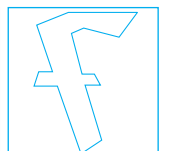
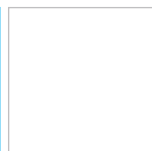
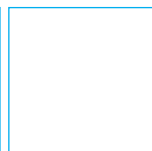



SET OF HOOKS AND BOXES

■ 01 ■ 02 ■ 03 ■ 04 ■ 05

**ORD. NO. F BL 9504 00 05**

Set of 4 boxes size 1
complete with bracket for connection
to the perforated back panels
Dimensions mm 450x160x75 h

**ORD. NO. F BL 9507 00 05**

Set of 3 boxes size 2
complete with bracket for connection
to the perforated back panels
Dimensions mm 450x230x130 h

**ORD. NO. F BL 9508 00 99**

Set of 6 hooks (tools excluded)
including:

no. 2 **C MV 10 022**, no. 1 **C MV 10 003**
no. 1 **C MV 10 036**, no. 2 **C MV 10 001**

GREY PL
F. 01

GREEN PL
F. 02

RED PL
F. 03

BLUE PL
F. 04

YELLOW PL
F. 05

INFO ■



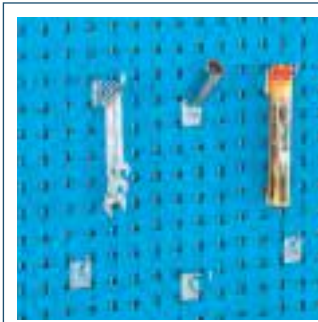

SINGLE HOOK

ORD. NO.	Ø	L
C MV 10 035	6	10
C MV 10 036	6	50

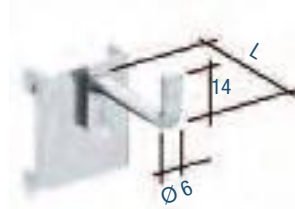

99



FLEXIBLE HOOK

ORD. NO.	L	B
C MV 10 002	28	9
C MV 10 003	33	17

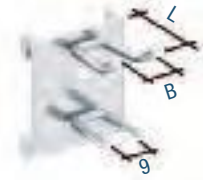

99



ANGLE SINGLE HOOK

ORD. NO.	Ø	L
C MV 10 014	4	50
C MV 10 015	6	100

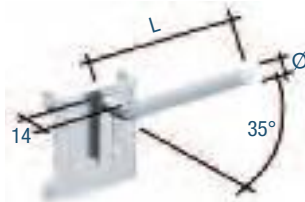

99



ROUND HOOK

ORD. NO.	Ø
C MV 10 030	60
C MV 10 032	80



99



ANGLE HOOK

ORD. NO.	Ø	L	B
C MV 10 016	5	50	40



99



CLOSED DOUBLE HOOK

ORD. NO.	Ø	L	B
C MV 10 004	5	70	25



99



LEVEL HOOK

ORD. NO.	Ø	L	B
C MV 10 001	5	20	43



99



**HOOK FOR BOXES
SIZE 01 - 0 - 1**

ORD. NO.	A	L	B
C MV 10 026	9	9	40

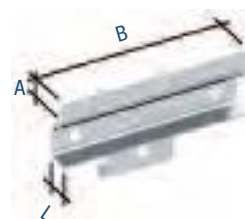

99

■ INFO

GALVANISED F.....99



www.famispa.com

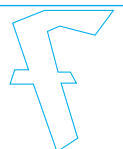

SERIES WORK-LOOK



FIXING CLAMP

ORD. NO.	Ø	L	B
C MV 10 027	3,5	170	29



99



SCREW DRIVER HOOK

ORD. NO.	Ø	L	B
C MV 10 018	12	220	32



99



CONTAINER HOOK

ORD. NO.	Ø	L
C MV 10 017	82	30



99

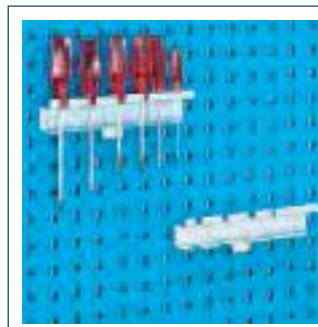

SPRING CLIP

ORD. NO.	L	B
C MV 10 019	238	40



99

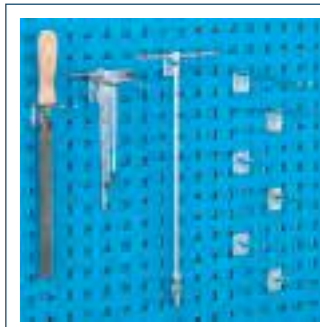

DOUBLE HOOK

ORD. NO.	Ø	L	B
C MV 10 005	5	38	7
C MV 10 006	5	38	11
C MV 10 007	5	55	25
C MV 10 008	5	64	7
C MV 10 009	5	64	11
C MV 10 010	5	100	25
C MV 10 011	5	150	10
C MV 10 012	5	150	25
C MV 10 013	5	200	15

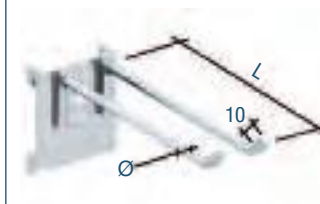

99



SUSPENSION HOOK

ORD. NO.	Ø	L
C MV 10 037	5	24
C MV 10 038	5	38
C MV 10 039	4	100
C MV 10 040	6	100
C MV 10 041	5	150
C MV 10 042	6	200



99



KEY HOOK

ORD. NO.	L
C MV 10 025	556

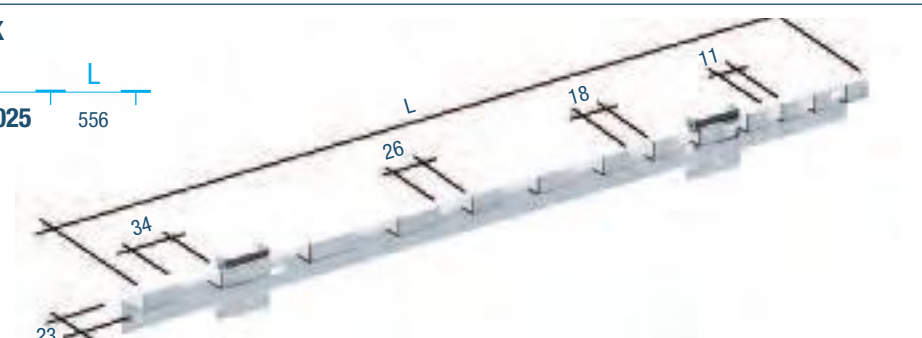

99

GALVANISED F... ..99



INFO ■

www.famispa.com



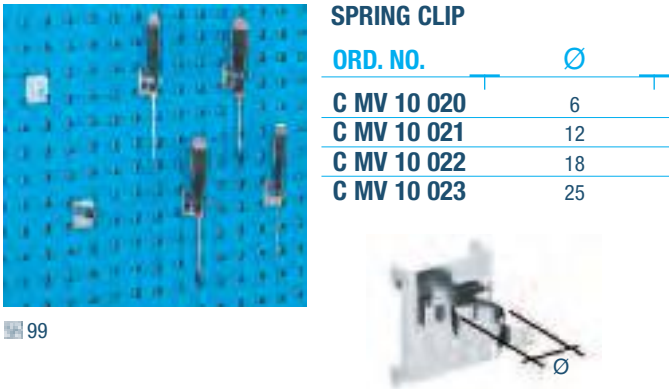

SPRING CLIP

ORD. NO.	Ø
C MV 10 020	6
C MV 10 021	12
C MV 10 022	18
C MV 10 023	25

99

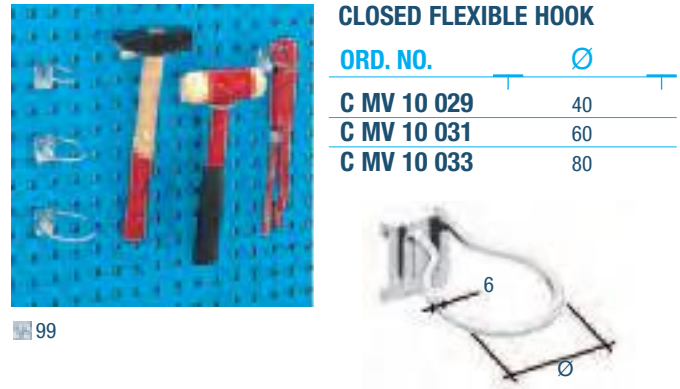

CLOSED FLEXIBLE HOOK

ORD. NO.	Ø
C MV 10 029	40
C MV 10 031	60
C MV 10 033	80

99

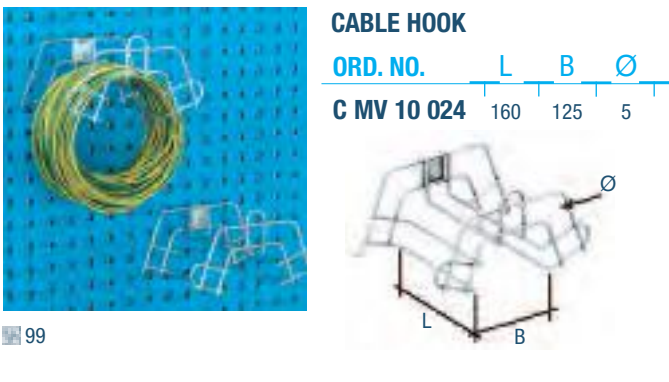

CABLE HOOK

ORD. NO.	L	B	Ø
C MV 10 024	160	125	5

99

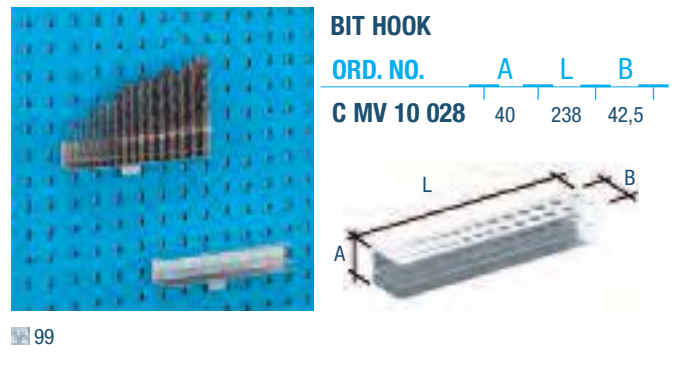

BIT HOOK

ORD. NO.	A	L	B
C MV 10 028	40	238	42,5

99



SHELF

ORD. NO.	A	L	B
C MV 10 043	10	350	120

99



**CONTAINER'S RAIL
SIZE 1/ SIZE 2**

ORD. NO.	A	L	B
F BL 7438 00 99	86	445	-

99

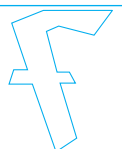

SERIES WORK-LOOK

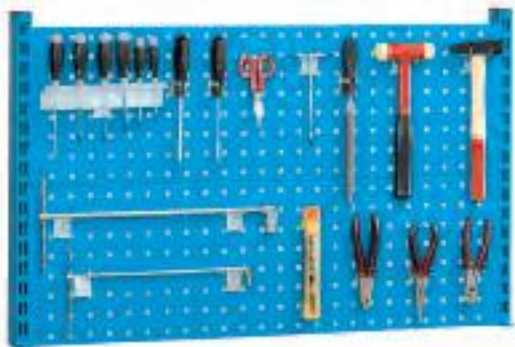

- 01
- 02
- 04
- 08

Including:

- no. 1 **C MV 10 019**
- no. 3 **C MV 10 001**
- no. 3 **C MV 10 022**
- no. 1 **C MV 10 003**
- no. 1 **C MV 10 007**
- no. 2 **C MV 10 016**
- no. 4 **C MV 10 036**
- no. 1 **C MV 10 014**

ORD. NO.

F BL 9502 00 99

Set of 16 galvanised hooks
without panels and support
columns

Tools excluded

ORD. NO.

F BL A010 18 04

Set of 16 galvanised hooks
with panels and support
columns ■ RAL 5012

Tools excluded



- 01
- 02
- 04
- 08

Including:

- no. 1 **C MV 10 016**
- no. 7 **C MV 10 037**
- no. 2 **C MV 10 038**
- no. 1 **C MV 10 001**
- no. 1 **C MV 10 007**
- no. 2 **C MV 10 021**
- no. 4 **C MV 10 022**
- no. 1 **C MV 10 025**

ORD. NO.

F BL 9512 00 99

Set of 19 galvanised hooks
without panels and support
columns

Tools excluded

ORD. NO.

F BL A010 21 04

Set of 19 galvanised hooks
with panels and support
columns ■ RAL 5012

Tools excluded

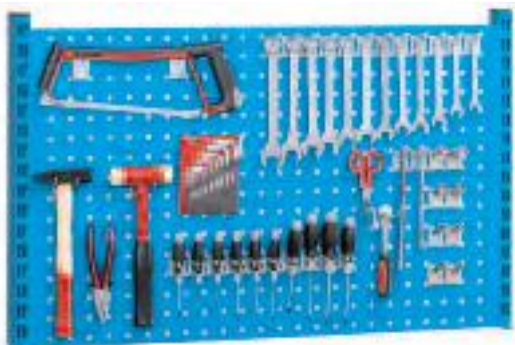

- 01
- 02
- 04
- 08

Including:

- no. 1 **C MV 10 016**
- no. 3 **C MV 10 007**
- no. 24 **C MV 10 037**
- no. 1 **C MV 10 001**
- no. 8 **C MV 10 021**
- no. 4 **C MV 10 022**

ORD. NO.

F BL 9511 00 99

Set of 41 galvanised hooks
without panels and support
columns

Tools excluded

ORD. NO.

F BL A010 20 04

Set of 41 galvanised hooks
with panels and support
columns ■ RAL 5012*

Tools excluded



- 01
- 02
- 04
- 08

ORD. NO.

F BL 9516 00 99

Set of 19 galvanised hooks
without panels and support
columns

Tools excluded

ORD. NO.

F BL A020 27 04

Set of 19 galvanised hooks
with panels and support
columns ■ RAL 5012

Tools excluded

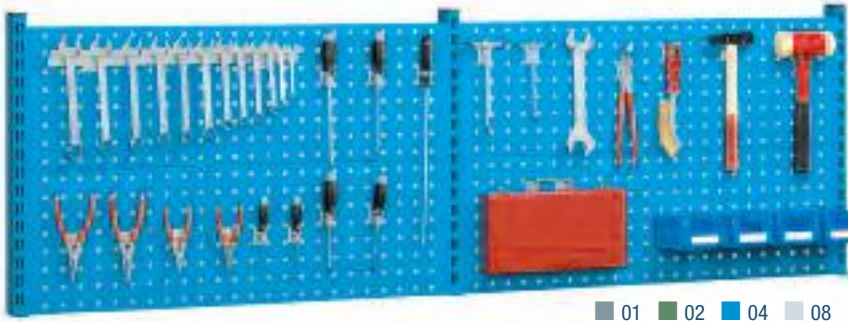

- 01
- 02
- 04
- 08

ORD. NO.

F BL 9522 00 99

Set of 22 galvanised hooks
without panels and support
columns

Tools excluded

ORD. NO.

F BL A020 33 04

Set of 22 galvanised hooks
with panels and support
columns ■ RAL 5012

Tools excluded

Including:

- no. 3 **C MV 10 037**
- no. 1 **C MV 10 036**
- no. 2 **C MV 10 002**
- no. 3 **C MV 10 016**
- no. 4 **C MV 10 001**
- no. 2 **C MV 10 020**
- no. 5 **C MV 10 022**
- no. 1 **C MV 10 025**
- no. 4 **F PM1751 00 04**
- no. 1 **F BL 7438 00 99**
- no. 4 **C MV 10 036**
- no. 1 **C MV 10 007**
- no. 1 **C MV 10 014**
- no. 1 **C MV 10 017**
- no. 3 **F PM2551 00 05**
- no. 2 **F BL 7448 00 99**

RAL 7000 F.01

RAL 6011 F.02

RAL 5012 F.04

RAL 7035 F.08

KEY ■

■ The support columns are 632 high, the panels are 1000 mm long and can be fitted to wooden worktops only.

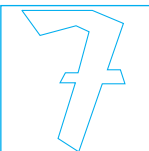



■ 01 ■ 02 ■ 04 ■ 08

ORD. NO.

F BL 9524 00 99

Set of 117 galvanised hooks
without panels and support
columns

Tools excluded

ORD. NO.

F BL A020 35 04

Set of 117 galvanised hooks
with panels and support
columns ■ RAL 5012

Tools excluded

Including:

- | | |
|--------------------------|--------------------------|
| no.61 C MV 10 037 | no. 2 C MV 10 016 |
| no. 1 C MV 10 025 | no.11 C MV 10 022 |
| no. 5 C MV 10 007 | no. 1 C MV 10 017 |
| no. 6 C MV 10 023 | no. 2 C MV 10 001 |
| no.12 C MV 10 021 | no.16 C MV 10 014 |



■ 01 ■ 02 ■ 04 ■ 08

ORD. NO.

F BL 9523 00 99

Set of 84 galvanised hooks
without panels and support
columns

Tools excluded

ORD. NO.

F BL A020 34 04

Set of 84 galvanised hooks
with panels and support
columns ■ RAL 5012

Tools excluded

Including:

- | | |
|--------------------------|--------------------------|
| no.34 C MV 10 037 | no.16 C MV 10 023 |
| no. 2 C MV 10 007 | no. 6 C MV 10 014 |
| no. 2 C MV 10 006 | no. 7 C MV 10 022 |
| no. 1 C MV 10 005 | no. 5 C MV 10 021 |
| no. 4 C MV 10 016 | no. 1 C MV 10 020 |
| no. 6 C MV 10 001 | |



■ 01
■ 02
■ 04
■ 08

ORD. NO.

F BL 9526 00 99

Set of 141 galvanised hooks
without panels and support
columns

Tools excluded

ORD. NO.

F BL A030 17 04

Set of 141 galvanised hooks
with panels and support
columns ■ RAL 5012

Tools excluded

Including:

- | | | |
|--------------------------|--------------------------|--------------------------|
| no. 2 C MV 10 017 | no.58 C MV 10 037 | no.23 C MV 10 014 |
| no. 1 C MV 10 025 | no.19 C MV 10 021 | no.12 C MV 10 022 |
| no. 3 C MV 10 007 | no. 9 C MV 10 001 | no. 9 C MV 10 023 |
| no. 2 C MV 10 036 | no. 2 C MV 10 016 | no. 1 C MV 10 020 |

■ KEY

■ RAL 7000 F.01 ■ RAL 6011 F.02 ■ RAL 5012 F.04 ■ RAL 7035 F.08



■ The support columns are 936 high, the panels are 1000 mm long and can be fitted to wooden worktops only.

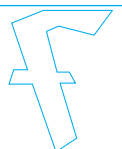

SERIES WORK-STEEL

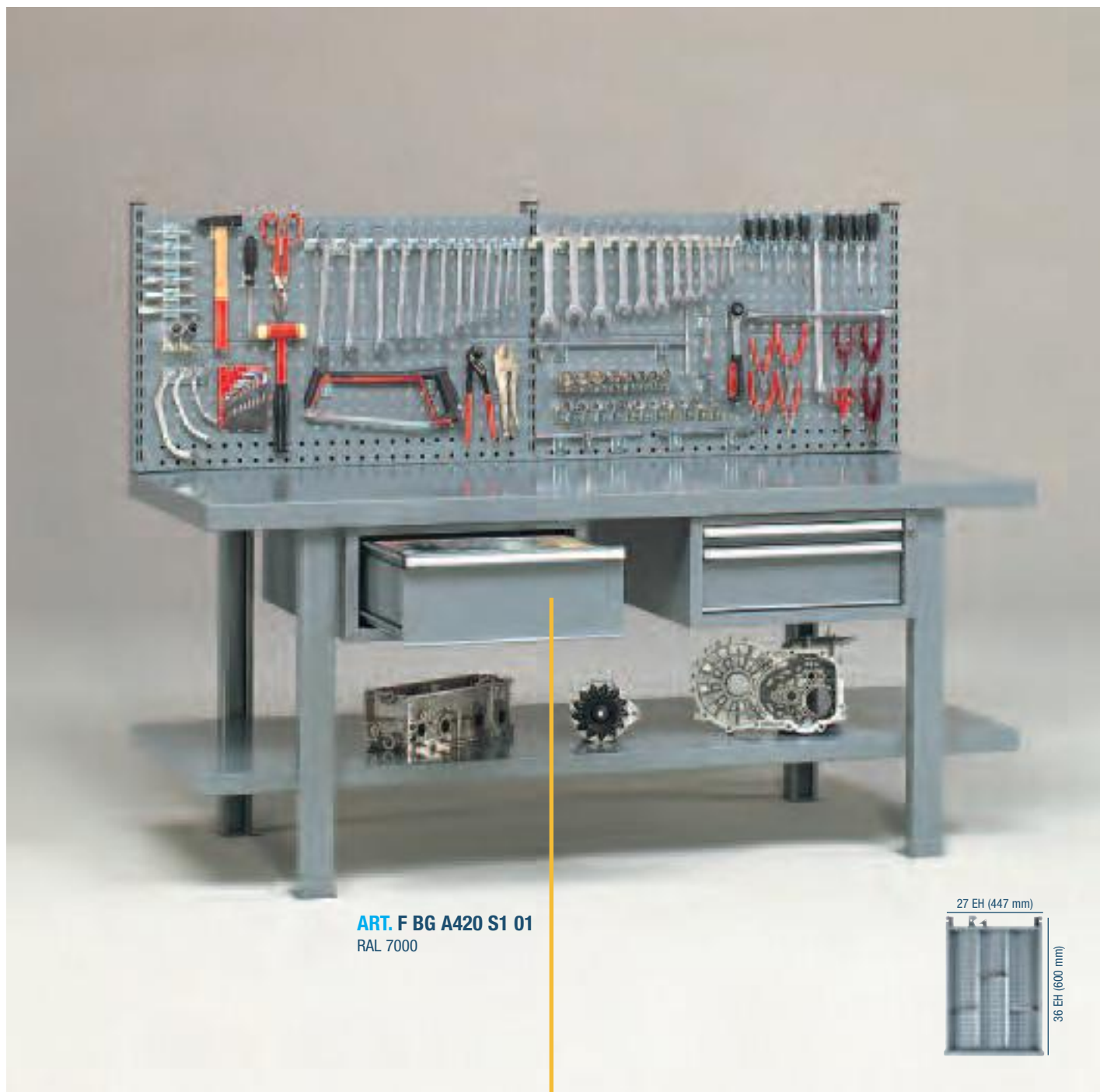

ART. F BG A420 S1 01
RAL 7000

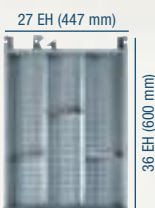
**WORKSTATION****ORD. NO.****F BG A420 S1 01**

Complete with multi-purpose back panels

Dimensions mm 2000/800x880/1515 h

Tools and set of partitioning material for drawers excluded

**SET OF PARTITIONING MATERIAL****ORD. NO.****F FH 8610 21 00**for 27x36 Eh drawer with
200 mm h front

RAL 7000 F.01

RAL 6011 F.02

RAL 5012 F.04

SUPPLEMENTARY PARTS ■

■ Set of
partitions see
page **A72 -
A73**



■ **Spare key.** Always indicate the number on the cylinder lock of the key to be replaced.

ORD. NO. R CSC 0002 00

■ **Master key.** This type of key opens all the 45 and 46 series locks.

ORD. NO. R CSC 0001 00



STEEL WORKSTATIONS 1200x750x880 mm h

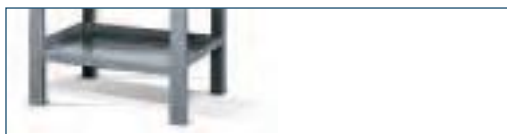
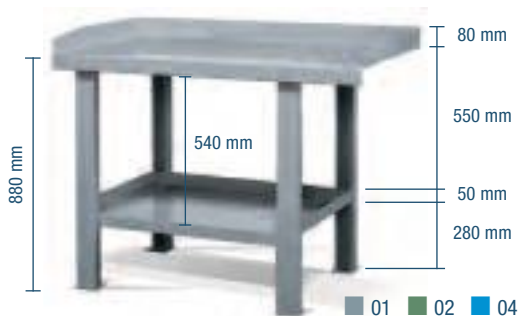

ORD. NO.	TYPE OF WORKTOP	WORKTOP LOAD CAPACITY kg	LOWER SHELF LOAD CAPACITY kg
F BG A120 00 01	Steel	2000	350
Dimensions mm 1200x750x880 h			



ORD. NO.	TYPE OF WORKTOP	WORKTOP LOAD CAPACITY kg	LOWER SHELF LOAD CAPACITY kg
F BG A120 01 01	Steel	2000	350
Complete with drawer unit			
Dimensions mm 1200x750x880 h			

STEEL WORKSTATIONS 1500x750x880 mm h



ORD. NO.	TYPE OF WORKTOP	WORKTOP LOAD CAPACITY kg	LOWER SHELF LOAD CAPACITY kg
F BG A220 00 01	Steel	2000	350
Dimensions mm 1500x750x880 h			



ORD. NO.	TYPE OF WORKTOP	WORKTOP LOAD CAPACITY kg	LOWER SHELF LOAD CAPACITY kg
F BG A220 01 01	Steel	2000	350
Complete with drawer unit			
Dimensions mm 1500x750x880 h			

KEY

RAL 7000 F.01 RAL 6011 F.02 RAL 5012 F.04



All indicated loads are net and refer to evenly distributed weights

Set of partitions see page A72 - A73



SERIES WORK

STEEL WORKSTATIONS 1500x800x880/1515 mm h



ORD. NO.	TYPE OF WORKTOP	WORKTOP LOAD CAPACITY kg	LOWER SHELF LOAD CAPACITY kg
F BG A320 00 01	Steel	2000	350

Dimensions mm 1500x800x880/1515 h



ORD. NO.	TYPE OF WORKTOP	WORKTOP LOAD CAPACITY kg	LOWER SHELF LOAD CAPACITY kg
F BG A320 01 01	Steel	2000	350

Complete with drawer unit
Dimensions mm 1500x800x880/1515 h



ORD. NO.	TYPE OF WORKTOP	WORKTOP LOAD CAPACITY kg	LOWER SHELF LOAD CAPACITY kg
F BG A320 03 01	Steel	2000	350

Complete with drawer unit
Dimensions mm 1500x800x880/1515 h



ORD. NO.	TYPE OF WORKTOP	WORKTOP LOAD CAPACITY kg	LOWER SHELF LOAD CAPACITY kg
F BG A320 53 01	Steel	2000	350

Complete with drawer unit and 2 perforated back panels total height 608 mm
Dimensions mm 1500x800x880/1515 h

RAL 7000 F.01 RAL 6011 F.02 RAL 5012 F.04

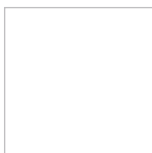
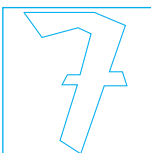

■ Set of partitions see page A72 - A73

KEY ■

■ All indicated loads are net and refer to evenly distributed weights



STEEL WORKSTATIONS 2000x800x880/1515 mm h



dimensions of lower shelf:
2000x665x50 mm h

ORD. NO.	TYPE OF WORKTOP	WORKTOP LOAD CAPACITY kg	LOWER SHELF LOAD CAPACITY kg
F BG A420 00 01	Steel	2000	350

Dimensions mm 2000x800x880/1515 h



dimensions of lower shelf:
2000x665x50 mm h

ORD. NO.	TYPE OF WORKTOP	WORKTOP LOAD CAPACITY kg	LOWER SHELF LOAD CAPACITY kg
F BG A420 01 01	Steel	2000	350

Complete with drawer unit
Dimensions mm 2000x800x880/1515 h



dimensions of lower shelf:
2000x665x50 mm h

ORD. NO.	TYPE OF WORKTOP	WORKTOP LOAD CAPACITY kg	LOWER SHELF LOAD CAPACITY kg
F BG A420 03 01	Steel	2000	350

Complete with drawer unit
Dimensions mm 2000x800x880/1515 h

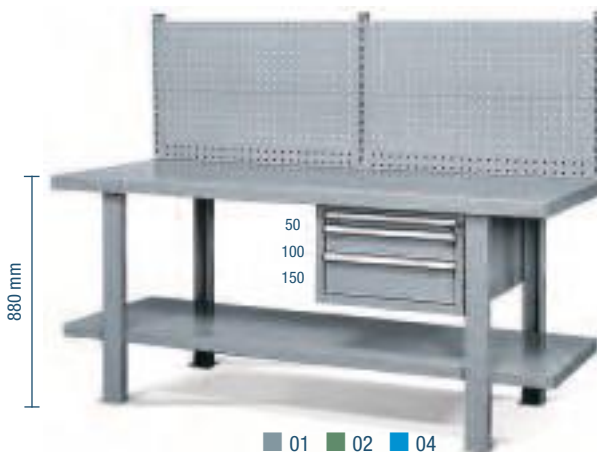

dimensions of lower shelf:
2000x665x50 mm h

ORD. NO.	TYPE OF WORKTOP	WORKTOP LOAD CAPACITY kg	LOWER SHELF LOAD CAPACITY kg
F BG A420 53 01	Steel	2000	350

Complete with drawer unit and 4 perforated back panels total height 608 mm
Dimensions mm 2000x800x880/1515 h

KEY

- RAL 7000 F.01
- RAL 6011 F.02
- RAL 5012 F.04



■ All indicated loads are net and refer to evenly distributed weights

■ Set of partitions see page A72 - A73

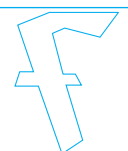

SERIES WORK-SEAT

BEECH-PLYWOOD CHAIRS



■ 07

ORD. NO.**F QZ 1111 00 07**

Swivel chair with double swivel wheels, seat and back in beech-plywood.
Seat height adjustable by screw.
Height: from mm 530 to mm 645.

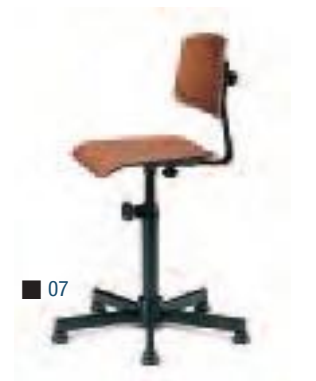

■ 07

ORD. NO.**F QZ 1110 00 07**

Swivel chair with low noise floor feet, seat and back in beech-plywood.
Seat height adjustable by screw.
Height: from mm 501 to mm 620.



■ 07

ORD. NO.**F QZ 1120 00 07**

Swivel chair with low noise floor feet and additional chromium-plated foot rest, height adjustable.
Seat and back in beech-plywood.
Seat height adjustable by screw.
Height: from mm 501 to mm 710.



■ 07

ORD. NO.**F QZ 1130 00 07**

Swivel chair with stationary base and painted foot rest.
Seat and back in beech-plywood.
Seat height adjustable by screw.
Height: from mm 510 to mm 710.



■ 07

ORD. NO.**F QZ 1211 00 07**

Swivel chair with double swivel wheels, seat and back in beech-plywood.
Seat height adjustable by gas pump.
Height: from mm 470 to mm 645.



■ 07

ORD. NO.**F QZ 1210 00 07**

Swivel chair with low noise floor feet, seat and back in beech-plywood.
Seat height adjustable by gas pump.
Height: from mm 445 to mm 625.

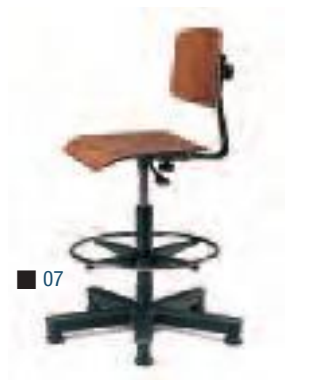

■ 07

ORD. NO.**F QZ 1220 00 07**

Swivel chair with low noise floor feet and additional chromium-plated foot rest, height adjustable.
Seat and back in beech-plywood.
Seat height adjustable by gas pump.
Height: from mm 510 to mm 760.



■ 07

ORD. NO.**F QZ 1310 00 07**

Swivel chair with low noise floor feet, seat and back in beech-plywood.
Seat height adjustable by molomatic screw.
Height: from mm 425 to mm 565.

POLYURETHANE CHAIRS

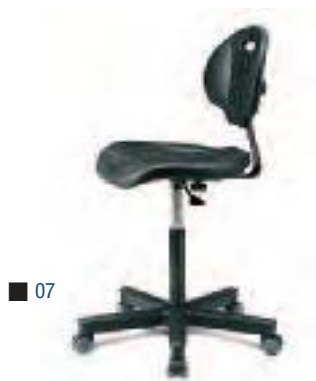

■ 07

ORD. NO.**F QZ 2211 00 07**

Swivel chair with double swivel wheels, seat and back in polyurethane.
Seat height adjustable by gas pump.
Height: from mm 495 to mm 670.



■ 07

ORD. NO.**F QZ 2210 00 07**

Swivel chair with low noise floor feet, seat and back in polyurethane.
Seat height adjustable by gas pump.
Height: from mm 470 to mm 650.



■ 07

ORD. NO.**F QZ 2220 00 07**

Swivel chair with low noise floor feet and foot rest.
Seat and back in polyurethane.
Seat height adjustable by gas pump.
Height: from mm 535 to mm 785.



■ 07

ORD. NO.**F QZ 2110 00 07**

Swivel chair with low noise floor feet and painted foot rest.
Seat and back in polyurethane.
Seat height adjustable by screw.
Height: from mm 535 to mm 735.

STEEL VICES



front opening

STEEL VICE JAW WIDTH 80 mm

ORD. NO. SUITABLE FOR

FBL 1010 00 00 Wooden worktop

FBL 1010 01 00 Steel worktop

A = 100 mm D = 83 mm
B = 330 mm E = knurled
C = 80 mm G = 4 kg



front opening

STEEL VICE JAW WIDTH 110 mm

ORD. NO. SUITABLE FOR

FBL 1015 00 00 Wooden worktop

FBL 1015 01 00 Steel worktop

A = 120 mm D = 113 mm
B = 385 mm E = knurled
C = 110 mm G = 7 kg



front opening

STEEL VICE JAW WIDTH 130 mm

ORD. NO. SUITABLE FOR

FBL 1020 00 00 Wooden worktop

FBL 1020 01 00 Steel worktop

A = 140 mm D = 137 mm
B = 430 mm E = knurled
C = 130 mm G = 11 kg



rear opening

STEEL VICE JAW WIDTH 120 mm

ORD. NO. SUITABLE FOR

FBL 1065 00 00 Wooden worktop

FBL 1065 01 00 Steel worktop

A = 175 mm D = 187 mm
B = 510 mm E = knurled
C = 120 mm G = 24 kg

CAST IRON VICES



rear opening

*CAST IRON VICE JAW WIDTH 100 mm

ORD. NO. SUITABLE FOR

FBL 1110 00 00 Wooden worktop

FBL 1110 01 00 Steel worktop

A = 140 mm D = 153 mm
B = 445 mm E = knurled
C = 100 mm G = 11 kg



rear opening

*CAST IRON VICE JAW WIDTH 120 mm

ORD. NO. SUITABLE FOR

FBL 1120 00 00 Wooden worktop

FBL 1120 01 00 Steel worktop

A = 185 mm D = 180 mm
B = 520 mm E = knurled
C = 120 mm G = 18 kg



rear opening

**CAST IRON VICE JAW WIDTH 150 mm

ORD. NO. SUITABLE FOR

FBL 1130 00 00 Wooden worktop

FBL 1130 01 00 Steel worktop

A = 220 mm D = 210 mm
B = 615 mm E = knurled
C = 150 mm G = 25 kg

* Cast iron vices can not be assembled on 30 mm thickness worktops.

** For wooden worktops 50 mm h only.

A = maximum jaw opening B = maximum width of vice C = width of jaws D = height of vice E = knurled jaws G = weight of vice

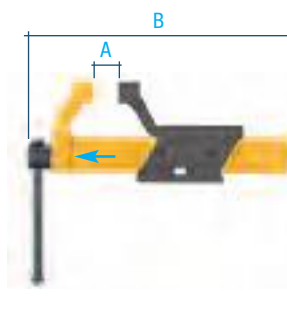
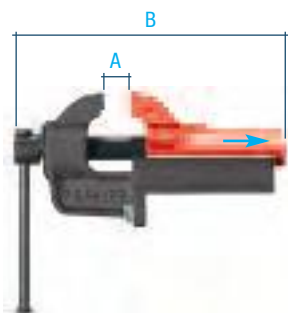

INFO



www.famispa.com

