



Flexible. Customizable. Upgradable.

Beds for modern healing spaces.



ACURA

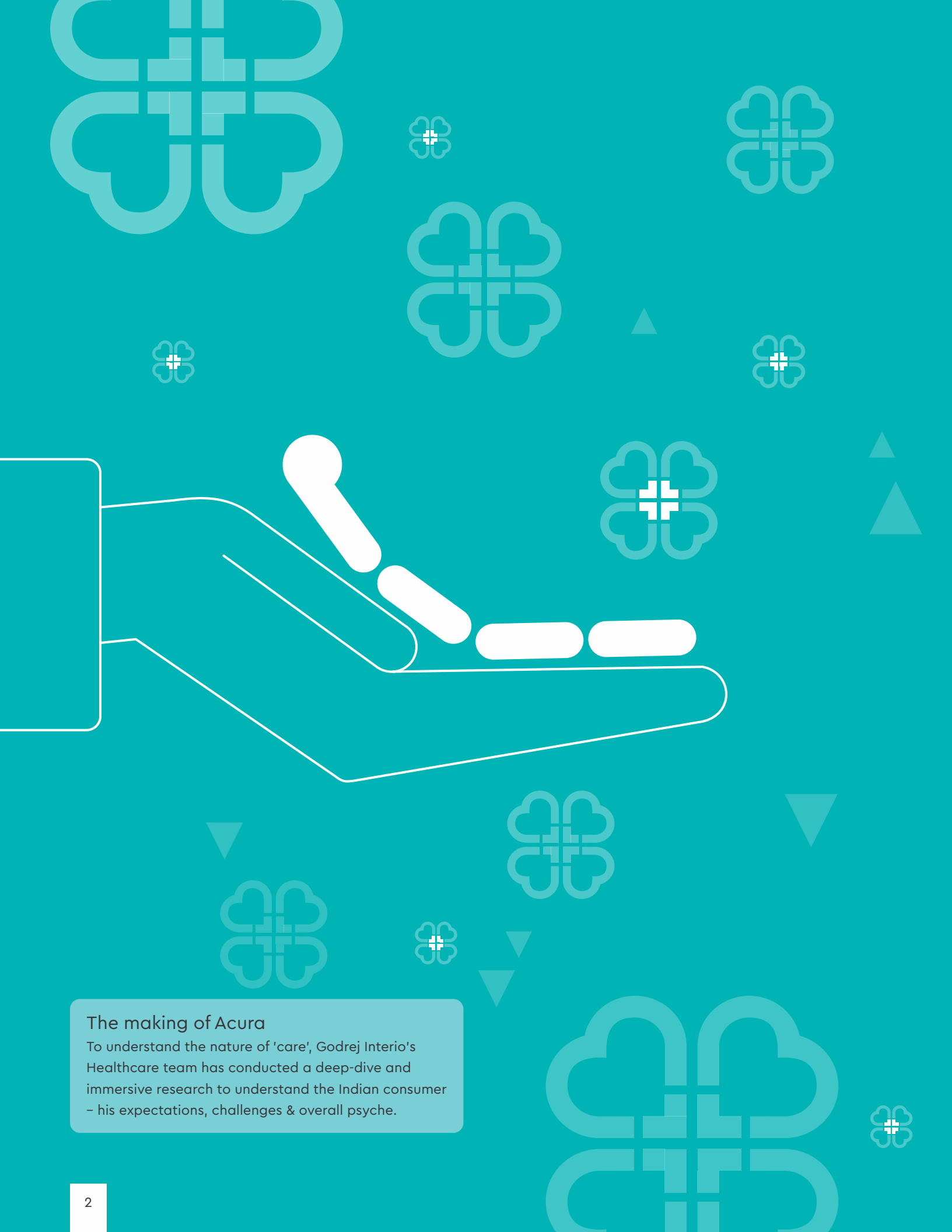

The making of Acura

To understand the nature of 'care', Godrej Interio's Healthcare team has conducted a deep-dive and immersive research to understand the Indian consumer - his expectations, challenges & overall psyche.

ACURA

Where design, innovation and healthcare converge

A platform-based range of hospital beds, Acura is designed to offer care, comfort and ease of operation at every stage. This range gives you 'Buy what you need' options for varying needs of different hospital environments.



Configured to your needs

Allows you to choose from a menu of options to configure bed according to your needs.



Bed Upgrades: Now Onsite & Easy

Acura beds come with the flexibility of converting manual functions to motorized ones with help of retrofit electronics kit on-site without making any structural changes in the bed. With this retrofit electronic kit, the manual functions of Back Rest, Leg Rest & Height Adjustment can be motorized at site in a few hours, thereby minimizing downtime, customer spend and associated environmental impact.

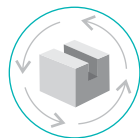

A more efficient product lifecycle

No reworks, no replacements. Acura offers the customer a financially more attractive solution to shift from manual to motorized. This solution will eliminate entire process of new product replacement; while saving on manufacturing, transportation and installment resources.

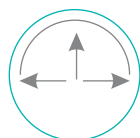

Range of finishes & functionalities

From the initial choice of finishes to a range of functionalities, Acura is designed to give you choice. The result is a bed that can adapt to the needs of an expanding healthcare facility across years.

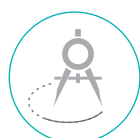

An example of Innovation in design engineering

Godrej Interio designers and engineers have created a new high performance adaptive bed platform, led by innovation in design engineering and implementation processes. The onsite upgradability feature in Acura has been patented.

Acura Beds

The smarter way to upgrade.



Unique platform range of beds
4 varieties of sideboard configurations
Onsite upgradability from manual to motorized

What makes the Acura 'Manual to Motorized' Range unique is the facility provided in the bed frame to shift from the manual crank adjustment to motorized adjustments, easily and quickly, onsite. This product range provides you a wide choice of hospital beds, that offer upgrade features making it the preferred choice for fast growing healthcare spaces.



Buy as you need, upgrade at your convenience

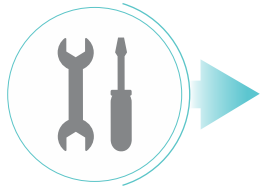

Start with bed having manual features

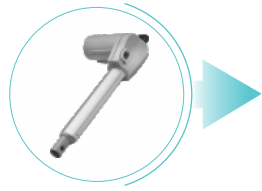

Purchase Acura Actuator System













Godrej Interio service technician installs the actuator on the bed, at your site









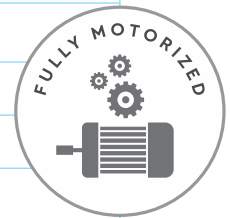



Bed upgraded from manual to motorized

Acura Prime

FUNCTION	BASIC BED	AT TIME OF PURCHASE
Backrest	Not applicable 	Motorized Functions 
Legrest	Not applicable 	Motorized Functions 
Height Adjustment	Not applicable 	Motorized Functions 
Trendelberg	Not applicable 	Motorized Functions 
Reverse Trendelberg	Not applicable 	Motorized Functions 





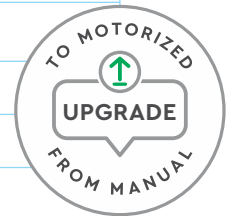

Acura Standard / Neo

FUNCTION	BASIC BED	POST UPGRADATION
Backrest	Manual Function 	Motorized Functions 
Legrest	Manual Function 	Motorized Functions 
Height Adjustment	Manual Function 	Motorized Functions 
Trendelberg	Manual Function 	Manual Function 
Reverse Trendelberg	Manual Function 	Manual Function 



Acura Vital

FUNCTION	BASIC BED	POST UPGRADATION
Backrest	Manual Function 	Motorized Functions 
Legrest	Manual Function 	Motorized Functions 
Height Adjustment	Not available	Not available
Trendelberg	Not available	Not available
Reverse Trendelberg	Not available	Not available

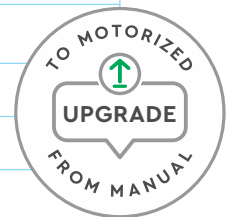

Acura Lite

The bed is a standard hospital bed, ideal for wards. Its sleek design ensures space saving while keeping the patient comfortable at all times.

Perfect for responsive healthcare spaces



Simple, Safe and Convenient



Bed function convertibility from manual to motorized



Compliant to International Standards



Configured to your needs



Adjustment features



Backrest adjustable upto 65°



Kneerest adjustable upto 30°



Lowest Height position



Maximum Height position



Trendelenburg



Reverse trendelenburg

Acura
Greater comfort,
greater efficiency.



Safety & comfort for patient.
High hygiene & ease of use for caregivers.
Premium aesthetics & a choice of options
for Hospital management.

Healthcare spaces today are expected to deliver at the highest standards of comfort, safety, efficiency and aesthetics. With minute attention to detail, we have designed Acura to meet the needs of various healthcare stakeholders. Confidently moving towards responsive healing spaces.



Acura Neo

Highly functional,
upgradable onsite.



A contemporary 5F manual functional bed offers full coverage sideboards, ensuring patient safety at all times. Acura Neo can be upgraded from manual to semi motorized at your site.

Acura Lite

Sleek, compact
& comfortable.



This standard bed is designed to fit into compact spaces and deliver necessary patient support and hygiene. With fixed metal lying surface and siderails for patient support, it is ideal for primary healthcare spaces.

*Also available in semi motorized variant.

The finer details



125 mm Castors* with diagonal locking:
Maneuverability is easier with 125 mm castors, making it easy for caregivers to mobilize patient, quickly.



Bumpers with excellent shock absorbing property:
Keep the bed safe, provide protection against collisions during shifting of bed.

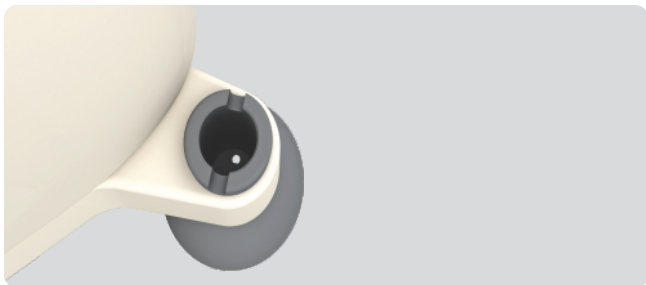

Provision for Lite IV Pole:
Provision for IV pole on all four corners of bed.



Urine Bag Holder:
MS hooks have been provided as urine bag holders on either side of bed, for ease of accessibility.



Emergency CPR Lever:
Helps achieve flat position of backrest in case of emergency, from either side of the bed.

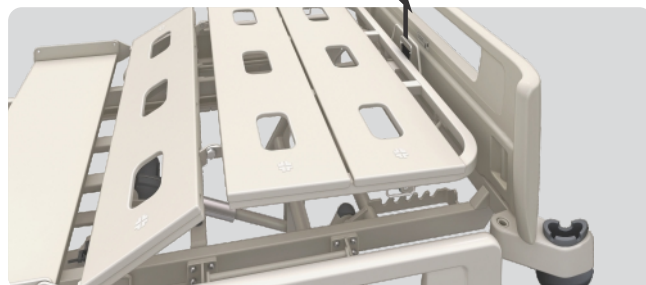

Leg Elevation:
Simple single hand operation to achieve leg elevation in case of DVT.

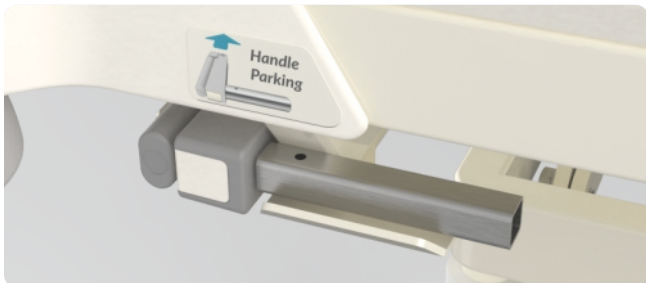

Crank handle parking:
The ergonomic crank handle can be safely placed at its dedicated safe parking position to avoid misplacement.

* Twin Wheel & Single Wheel Castor options available.

Safety



Full Coverage Safety Sideboards: Patient safety is at the core of our design. The full coverage sideboards provide utmost safety and make patient handling easier.



Zero Entrapment zones: IEC - 60601-2-52 Safety Standards compliant, ensures body parts of caregivers and patient are safe at all times.



Separate angle indicator for headboard and footboard: Caregiver has access to angle readings of bed at all times, helps in achieving safe position for patient.

Hygiene



Removable Lying surfaces: The removable PP lying panels make cleaning and maintaining high hygiene standards easier.

Note: Acura Neo and Acura Lite come with fixed metal lying surfaces, that can be cleaned with standard cleaning materials.



Removable Plastic Headboard & Footboard: For easy cleaning or in case of emergencies.



Adequate Under-bed clearance: The optimum Under-bed clearance (>15 cm) ensures unobstructed placement of medical equipment under the bed; ease of bed maintenance.

Side Support

Our wide range of sideboards and siderails options gives you the opportunity to create safe healthcare spaces with new age aesthetics. Choose the ones best suited to your hospital environment and patient needs.

Plastic Sideboards

Provide full coverage with drop down mechanism. The sideboards, with superior surface texture and finish, are **rotatable** with back rest.

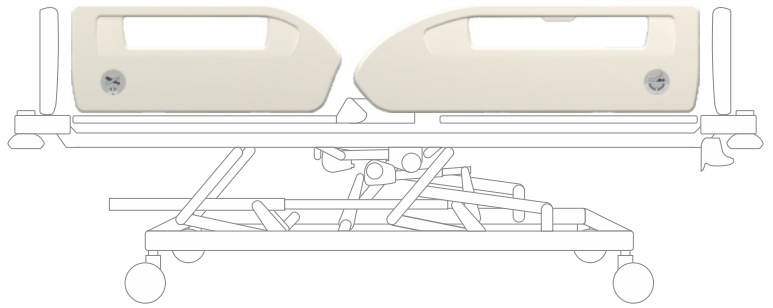

Aluminium Sideboards

Provide full coverage with drop down mechanism. The sideboards with classic Aluminium touch in matte finish give the bed a novel look.

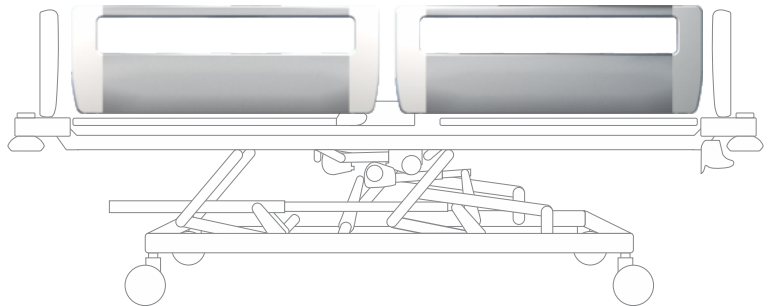

Aluminium Siderails

Provide 3/4th coverage with drop down mechanism. These siderails provide a distinct look to the bed, while meeting the standards of patient safety.

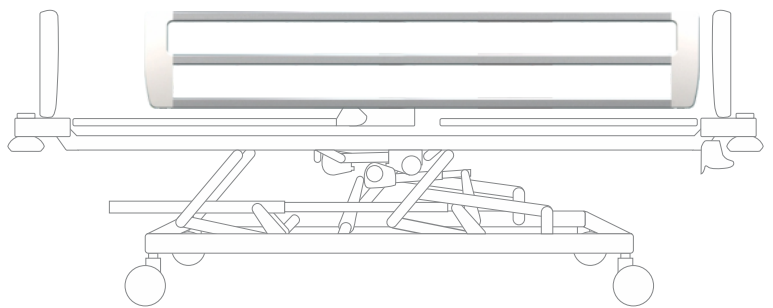

MS Siderails

The MS powder coated collapsible siderails provide optimum coverage with swing side mechanism. Lowering the siderails vertically is easy which makes it ideal for use in confined spaces.

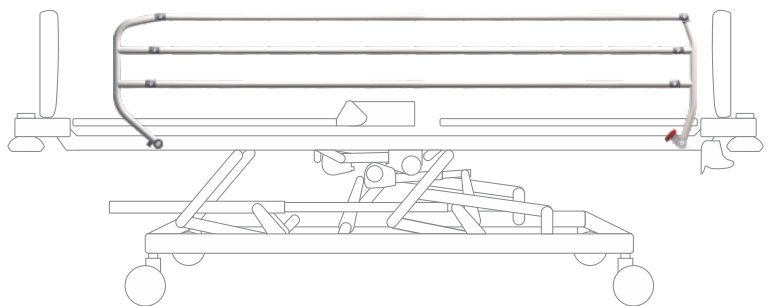

Technical Specifications

	Acura Prime	Acura Standard/Lite	Acura Standard	Acura Lite/Neo	Acura Vital
	Fully Motorized Beds	Semi Motorized Beds	5F Manual Beds	5F Manual Beds	2F Beds Manual/Motorized
Onsite Upgradability from Manual to Motorized	NA	NA	Available	Not Available	Available for 2F Manual
Manual/Motorized	Motorized	3F Motorized, TR/ATR Manual	Manual	Manual	Manual/Motorized

Backrest	65°	65°	65°	65°	65°
Kneerest	30°	30°	30°	30°	30°
TR	13.5°	12°	12°	12°	NA
ATR	13.5°	8°	8°	8°	NA
Height Adjustment	44 to 77 cm	49 to 75 cm	49 to 75 cm	49.8 to 75.8 cm	Fixed Height: 56.1 cm
Safe Working Load	200 kg	200 kg	200 kg	200 kg	200 kg
Patient Load Bearing Capacity	135 kg	135 kg	135 kg	135 kg	135 kg

Lying Surface	Removable Plastic Surface	Removable Plastic Surface/Metal Surface	Removable Plastic Surface	Metal Surface	Removable Plastic Surface
Castors	Twin Wheel	Twin Wheel/Single Wheel	Twin Wheel	Single Wheel	Twin Wheel
Locking Mechanism	Diagonal Locking	Diagonal Locking	Diagonal Locking	Diagonal Locking	Diagonal Locking
Side Support	Plastic Sideboards, Aluminium Sideboards	All 4 Options Available	Plastic Sideboards, Aluminium Sideboards, Aluminium Siderails	Plastic Sideboards, MS Siderails	Plastic Sideboards
Xray Permeable Back	Standard	Optional	Optional	Optional	Optional
Leg Elevation Position	Manual on Ratchet	Manual on Ratchet	Manual on Ratchet	Manual on Ratchet	Manual on Ratchet
Manual CPR Lever	Both Sides	Both Sides	NA	NA	Both Sides for 2F Motorized Variant

Dimensions of all variants: Length: 224 cm +/- 0.05 cm; Width: 105 cm +/- 0.05 cm

Accessories



Actuator Kit: The retrofit Actuator Kit is used to upgrade the bed features from manual to motorized.

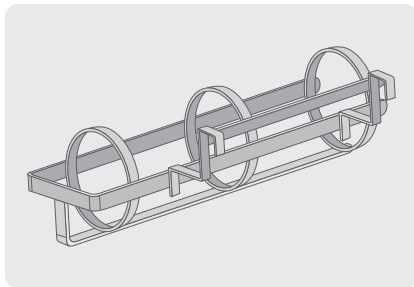

Oxygen cylinder holder
Supports mobile respirator with spontaneous breathing mode.

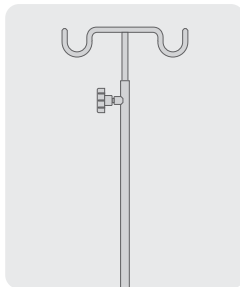

Lite IV Pole
Ergonomic SS IV pole, easy to use at any bed corner.

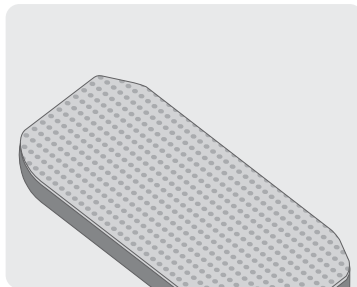

Mattress
Patient responsive mattress is the ideal match, facilitating comfort and quick recovery.

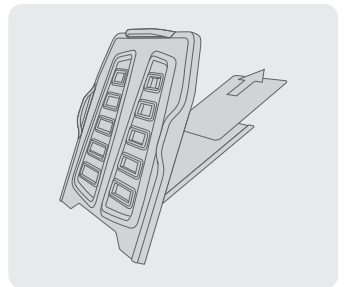

X-ray permeable back
Eliminates the need to shift patient for X-ray purposes, reduces stress on patient and caregiver.

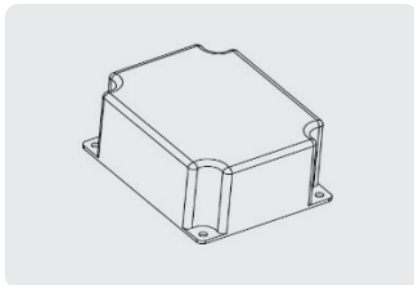

Battery backup
When motorized beds are unplugged from power source, all bed functions can be supported with battery backup. This makes it easy to shift bed across wards and floors.

World Class Standards & Certifications

Patent No. 202021004945

IEC 60601-1 Medical Electrical Equipment: General requirements for safety and essential performance.

IEC 60601-2-52 Medical Electrical Equipment: Particular requirements for safety and essential performance of medical beds.

IEC 60601-1-2 Electromagnetic compatibility. (Requirements & Tests)

IEC 60601-1-4 General Requirements for Safety: Programmable electrical medical systems.

ISO 14971 Medical Devices: Application of risk management to medical devices.

ISO 13485:2016 Medical Devices: Quality Management Systems - Requirements for regulatory purposes.

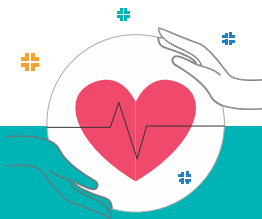

The modern healthcare space is an ecosystem developed for patient care and comfort. It comprises of care givers, equipment and technology. Godrej Interio Healthcare is glad to be contributing towards making this ecosystem safer, greener and more thoughtful.



AVAILABLE IN OVER 600 LOCATIONS ACROSS INDIA

Put some play into your work by visiting
godrejinterio.com

An initiative by Godrej Interio, the first Indian furniture company with **GREENGUARD** certified products

MODULAR FURNITURE • DESKING • SEATING • STORAGE • INTERIORS • LAB • MARINE • HEALTHCARE • HOME

Local Address

National

North: Delhi, Chandigarh, NCR, Lucknow

South: Chennai, Bengaluru, Hyderabad, Kochi

West: Mumbai, Ahmedabad, Bhopal, Pune

East: Kolkata, Bhubaneswar, Guwahati, Patna

In keeping with the Godrej policy of continuous development and improvement, the design, dimension and specification may be updated without prior notice or obligations. Form, Colour and Finish of product in this document are representative of design intent and may vary from actual. Colour options depicted in this catalogue are as close to what modern printing processes allow. All dimensions are in 'cm' and are subject to commercial tolerance. Our products are meant for indoor use only.

Godrej & Boyce Mfg. Co. Ltd.

Godrej Interio, Pirojshanagar, Vikhroli (W), Mumbai – 400 079.

Toll Free Number: 1800-267-1122. Fax: +91-22-6796 1503

Email: interiohospital@godrej.com

Website: www.godrejinterio.com

Follow us on



[/godrejinterio](https://www.facebook.com/godrejinterio)



[/godrej-interio](https://www.linkedin.com/company/godrej-interio)



[/godrejinterio](https://www.youtube.com/godrejinterio)



[/godrejinterio4u](https://twitter.com/godrejinterio4u)