



**Enhancing Collaboration,
Empowering Businesses.**

Godrej AV Solutions

Godrej AV Solutions, one of the most experienced and leading audio visual solutions provider, brings audio visual products and solutions that seamlessly integrates audio, video, display, lighting equipment and system controls for applications such as boardrooms, conference rooms, auditoriums, training rooms, cafeterias, telepresence rooms and much more. Our partnership with leading AV product manufacturers across the world, enable us to offer state-of-the-art products and solutions.

With pan India presence and team of around 230 professionals, Godrej AV Solutions helps organizations in enhancing collaboration with enriching experience. Our team consists of some of the most experienced audio visual integration specialists in the industry and several Godrej AV Solutions specialists hold international certifications and awards.

With a focus on global consistency and quality, Godrej AV Solutions is the exclusive India member of the Global Presence Alliance (GPA) – a network of specialist audio, video and unified communication companies that streamline how people work together across the world.



Markets - Our Industry Expertise

Godrej AV Solutions offers audio visual solutions for various market verticals in India. Being a leading audio visual solutions provider, we provide solutions to market verticals such as education, enterprise, BFSI, government, defence, healthcare and hospitality.

Our expert designers and sales consultants ensure that needs and expectations of different market verticals are well understood and solutions are designed and implemented accordingly. Our solutions ensure that right collaboration and communication tools are provided according to each vertical need.

Our solutions help customers in enhancing collaboration, improve operational efficiency and productivity.



Our Solutions Offering

Effective communication is a key to success of business processes for any organisation. It helps organisations across market verticals in managing, collaborating and inspiring people.

We, at Godrej AV Solutions help organisations with state-of-the-art audio visual solutions which help in enhancing collaboration and improving productivity. Our experienced sales and design consultants fully understand the needs and expectations of customers and offer innovative solutions that seamlessly integrate audio, video, display, lighting equipment and system control for all enterprise collaboration applications.

Boardroom / Conference / Huddle Room

We understand the collaboration needs of modern organizations and offer solutions to meet those needs. A typical state-of-the-art boardroom / conference / huddle room integrates various technologies like audio, video, display, lighting and system control to function effectively.

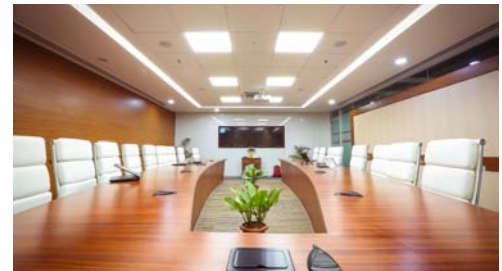

Digital Classroom / Training Room

We help organizations in upgrading traditional classrooms / training rooms into dynamic learning environment by selecting the right technology in line with the need. Our solutions achieve unique requirements of each customer, encourage collaboration and improve effectiveness of every interactive learning environment.

Visual Communication / Immersive Telepresence – Video Conferencing

As one of the most experienced and a market leader in providing visual communication solutions, we bring host of visual collaboration solutions for our customers. Our relationship with leading technology providers like Cisco, Polycom and LifeSize helps in bringing the right solutions to our customers.



Recording, Streaming and Content Management

We offer recording, streaming and content management solutions which maximizes the impact, reach and value of media. Our expert design and sales consultants will understand your requirement and develop an appropriate solution.

Information Display (Digital Signage)

Godrej AV Solutions, through its relationship with leading players in the industry like 3M, Samsung, Panasonic and Scala brings you wide range of solutions. Our solutions help organisations to deliver a variety of dynamic information using audio, video, still, or moving images to their target audience.



Video Wall Display

We offer video wall solutions from leading manufacturers like BARCO, Christie, Panasonic, Samsung etc. Our team with experience of having installed some of the largest video wall solutions in India will help in choosing the most appropriate solution for your requirement. Our solutions offer right choice of technology, high reliability and ease of use.



Paging and Background Music

We understand the specific needs of customers and help them with the optimum design for the audio requirement. Our key focus in an audio design is superior experience to the user, convenience to the operator and best return on investment.

Auditorium / Seminar Hall

We understand the audio visual facility requirement of modern auditoriums and help organisations to set up a state of the art auditorium facility with latest audio visual technologies. Our certified design consultants ensure that the modern auditorium requirements such as projection display, sound reinforcement, acoustic treatment, lighting and peripheral connectivity are well understood and right solution is designed to meet expectations of all stake holders.



Experience Centre

We help organizations to design and implement innovative and unique audio visual solutions that deliver exceptional interactive experience for visitors by incorporating some of the world's most advanced audio visual technologies.

Cafeteria / Break-out Room

A perfectly design and implemented audio visual solution plays a major role in making up cafeterias / break-out room's employee friendly. Sometimes, these locations also double up as meeting places when an organization wants to communicate with larger group of employees or use as venue for large gathering of employees.



Centralised Monitoring and Management

It is important that system and technology that typically operate in silos required to be integrated so that they work together as a single cohesive system. Our centralised monitoring and management solutions help organizations with powerful tools such as centralised device management, room scheduling, remote helpdesk and data collection and reporting.

Services



Consultancy and Design

- Godrej AV Solutions offers consultancy and design services to customers, architects, project management organisations through a team of certified experts.
- We help customers in evaluation of audio visual need, understanding technology and its applications, development of functional designs and finalising bill of materials.

Project Management

- With a team of certified project management professionals, Godrej AV Solutions is committed to its customers for efficient and on time project integration and implementation.
- Godrej AV Solutions project managers ensures proper understanding of the project scope, schedule, resource requirement, risks etc so that they can deliver the project on time and ensure quality outcome.



Technology and Application Training

- The most important phase of AV project implementation is technology and application training of solution implemented to end users. It is very critical that end users properly understand the facility and know how to use the same for best outcomes.
- Our project managers and engineers ensure that effective end user training process is followed which includes understanding of training requirement, preparation of training manual, providing effective training to both users and the nominated administrators.

Project Support and Maintenance

- Godrej AV Solutions understands the criticality of AV system for business and our processes are tuned to provide prompt and reliable after sales support through a team of certified engineers. Our Pan India presence helps our customers to receive uniformly high standard service across the country.
- To ensure long term maintenance and upkeep of the equipment of our customers, Godrej AV Solutions offers annual maintenance contract. We offer various types of service contract options to ensure high uptime for our customers.

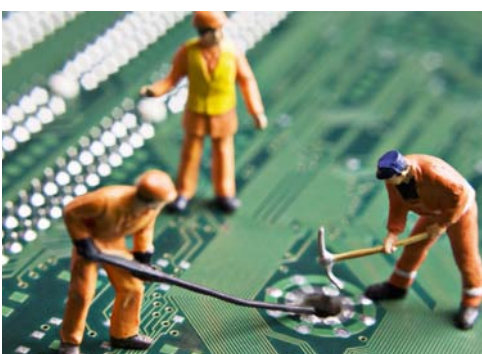

Technology Upgrade

- With the continuously changing technology environment, it is most important for the clients to ensure that their AV facility is upgraded to latest technology to derive the best out of technological advancements. It is very important for clients to continually upgrade their AV technology across all facilities.
- We at Godrej AV Solutions ensure that the rapid changes in AV technologies are continuously monitored, understood and new solutions are developed and offer upgrade programmes to our clients.

Why Godrej AV Solutions – Our strength



Our Client-Centric Consultative Approach

Our customers are our number one priority for us. Godrej AV Solutions has a large number of satisfied and loyal customers across India. Our client-centric consultative approach enables us to earn the trust of our clients and build long term relationships.



Our Skilled & Professional Team

Since inception, Godrej AV Solutions has built up the most talented, skilled and experienced personnel in the AV industry. This is evident through high employee satisfaction levels, testimonies of our clients & the policy we exercise internally to train and develop our staff.



Strong Network of Partners

Godrej AV Solutions partners with leading global audio visual product manufacturers to provide customers with leading technology product and solutions to address their collaboration needs. Through our wide partners network we are able to offer host of products best fit for our client's application.



Latest Technology Solutions

Technology solutions and trends are constantly changing. Godrej AV Solutions continuously monitors these trends and ensures that it offers them to customers. We provide wide-range solutions, services and maintenance of technology solutions by a qualified team of experts.



Established Pan India Presence & Track Record of Success

Godrej AV Solutions has an established presence across Pan India and has a track record of successfully implementing state-of-the-art technology solutions based on the customer's unique requirements.



Commitment to Deliver

Godrej AV Solutions has the utmost commitment to its clients, it thinks of the relationship with its clients as a solid long-term partnership with common goals; that is to meet the requirements of the clients as well as help them to achieve their business goals.



Quality Management

Godrej AV Solutions has a well-established Quality Management System in place to ensure that we deliver the highest quality solutions consistently to our customers.



Enhanced Customer Support

Godrej AV Solutions offers country wide customer support to its clients to ensure the continuity of their businesses. We also offer annual maintenance contracts to ensure high uptime for our customers.

Our Partners

Godrej AV Solutions works closely with world class audio visual product manufacturers to deliver best-in-class solutions to our clients.

The logo for Crestron, featuring a stylized blue swirl icon followed by the word "CRESTRON" in a bold, blue, sans-serif font.The logo for Extron Electronics, featuring a circular icon with a stylized 'E' and the text "Extron Electronics" in a blue, sans-serif font.The logo for Harman, featuring a stylized blue arc above the word "HARMAN" in a blue, sans-serif font.The logo for Kramer, featuring a large, stylized black letter 'K' with the word "KRAMER" in a smaller, black, sans-serif font below it.The logo for Barco, featuring the word "BARCO" in white on a red rectangular background, with the tagline "Visibly yours" in a smaller font below it.The logo for Christie, featuring the word "CHKISTIE" in a bold, blue, sans-serif font.The logo for Polycom, featuring a stylized red and white circular icon followed by the word "Polycom" in a black, sans-serif font.The logo for Cisco, featuring a stylized blue and red bar chart icon above the word "CISCO" in a red, sans-serif font.The logo for Lifesize, featuring a stylized blue circular icon followed by the word "lifesize" in a blue, sans-serif font.The logo for Panasonic, featuring the word "Panasonic" in a blue, sans-serif font.The logo for Epson, featuring the word "EPSON" in a bold, blue, sans-serif font.The logo for Samsung, featuring the word "SAMSUNG" in white on a blue oval background.The logo for NEC, featuring the word "NEC" in a bold, blue, sans-serif font.The logo for 3M, featuring the word "3M" in a bold, red, sans-serif font.The logo for Draper, featuring the word "DRAPER" in a bold, orange, sans-serif font.The logo for d|p, featuring the letters "d" and "p" in a black, sans-serif font, separated by a vertical bar.The logo for LG, featuring a stylized red and white circular icon followed by the letters "LG" in a black, sans-serif font.The logo for Sennheiser, featuring a stylized blue and white icon followed by the word "SENNHEISER" in a blue, sans-serif font.The logo for Chief, featuring a stylized yellow and black icon followed by the word "CHIEF" in a black, sans-serif font.The logo for Beyerdynamic, featuring the word "beyerdynamic" in a black, sans-serif font, followed by a stylized blue and black icon.The logo for ClearOne, featuring the word "ClearOne" in a bold, black, sans-serif font.The logo for Shure, featuring the word "SHURE" in a bold, black, sans-serif font.The logo for DataVideo, featuring the word "datavideo" in a blue, sans-serif font.The logo for Revolabs, featuring a stylized blue and white icon above the word "revolabs" in a blue, sans-serif font.The logo for Biamp, featuring the word "biamp" in a bold, black, sans-serif font.The logo for Music, featuring the word "MUSIC" in a red, sans-serif font.The logo for Bose Professional, featuring the word "BOSE" in a white, sans-serif font on a black background, with the word "PROFESSIONAL" in a smaller font below it.The logo for Wacom, featuring a stylized multi-colored icon above the word "wacom" in a black, sans-serif font.

Our Customers



Godrej | AV SOLUTIONS

Godrej & Boyce Mfg. Co.Ltd.,
Godrej Prima, Plant 14P, Pirojshanagar,
Vikhroli (East), Mumbai – 400079. Phone No. 022 - 6796 2665/2666/2653.
Email : avsolns@godrej.com, Website: www.godrejavolutions.com

Branches:

- Mumbai • Delhi • Kolkata • Chennai • Bengaluru • Hyderabad • Kochi • Pune
- Ahmadabad • Chandigarh • Jaipur • Lucknow • Bhopal • Guwahati

 /godrejavolutions

 /godrej-av-solutions

Godrej interio

AVAILABLE IN OVER 600 LOCATIONS ACROSS INDIA
Put some play into your work by visiting
godrejinterio.com

 **Talk Green.
Walk Green.**

An initiative by Godrej Interio, the first Indian furniture company with **GREENGUARD** certified products

MODULAR FURNITURE • DESKING • SEATING • STORAGE • INTERIORS • LAB • MARINE • HEALTHCARE • HOME

Local Address

National

North: Delhi, Chandigarh, NCR, Lucknow
South: Chennai, Bengaluru, Hyderabad, Kochi
West: Mumbai, Ahmedabad, Bhopal, Pune
East: Kolkata, Bhubaneswar, Guwahati, Patna

Godrej & Boyce Mfg. Co. Ltd.

Godrej Interio, Pirojshanagar, Vikhroli (W), Mumbai - 400 079.
Toll Free Number: 1800-267-1122. Fax: +91-22-6796 1503
Email: interiooffice@godrej.com
Website: www.godrejinterio.com

In keeping with the Godrej policy of continuous development and improvement, the design, dimension and specification may be updated without prior notice or obligations. Form, Colour and Finish of product in this document are representative of design intent and may vary from actual. Colour options depicted in this catalogue are as close to what modern printing processes allow. All dimensions are in 'cm' and are subject to commercial tolerance. Our products are meant for indoor use only.

Follow us on

 /godrejinterio

 /godrej-interio

 /godrejinterio

 /godrejinterio4u

Godrej interio



Agile conference rooms for future businesses



B2BMINGLEFEB2020

 **MINGLE**
CONFERENCING SOLUTIONS

Set the tone for effective business engagements

From brainstorming sessions to interactive trainings to video conferences, corporate conference rooms are today expected to deliver at multiple levels; while keeping technology hassle free.

To meet the evolving needs of contemporary conference spaces, Godrej Interio introduces MINGLE range of Conference Room Solutions. This wide range has synergized conference furniture with AV technologies to facilitate seamless collaborations and interactions.

So, whether you are looking at doing up a huddle room or a video conferencing space or a traditional large format board room with advanced technology integration, Mingle has a solution for you.

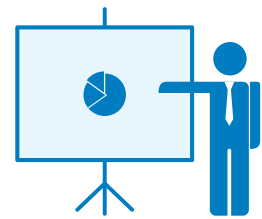

Presentations & Trainings



Team Meetings

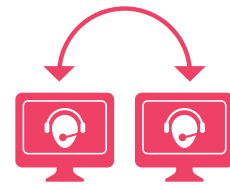

Video Conferencing



Meetings with visitors



Collaborative spaces

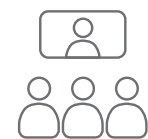

Technology for connectivity

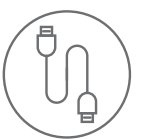

Sleek Visual Tech

Tailor make your conference rooms to suit your business needs



Innovative new technologies are transforming conference rooms into collaborative environments that foster creativity, boost productivity and give businesses a competitive edge with a connected workforce. More organisations are tailoring their meeting rooms to specific types of meetings.

A well-designed conference room takes into account the gadgets to be used, distance from screen, personal space and leg space each user will need, etc. All these factors determine the comfort of a conference room.

A well planned and equipped conference room with the latest AV and networking technology compatibility goes a long way in keeping the workforce productive, connected and inspired.

What employees expect from conference room technology

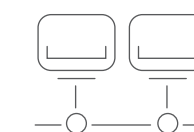

Hassle free connectivity

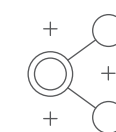

Plug n play technology

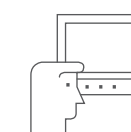

Satisfying User Experience

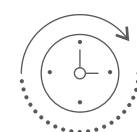

Future ready

MINGLE COLAB

Making VC uncomplicated and more productive.

Today's digital and technology businesses are driven by communications. Employees expect in-office conferencing facilities to be as convenient to use as smartphone video calls. Colab has been designed as a Plug & Play video conferencing solution. All it requires is a power supply, laptop with VC software and internet connectivity.



Effective tech integration into workspace

Operates as Huddle space, eliminates need for VC room

Worktop designed for all round visibility during VC

Registered Design No: 317042-004



Regular seating with Colab

Features



Ergonomic desktop edge



Inbuilt provision of Screen & Camera



Comprehensive wire management

AV Upgrades



Display: 40 to 50 inches professional display with mounting bracket



LOGITECH MEET UP USB Camera

Cable & Connectors kit:
3m HDMI presentation cable - 1 No.

Designed to give optimum viewing angle

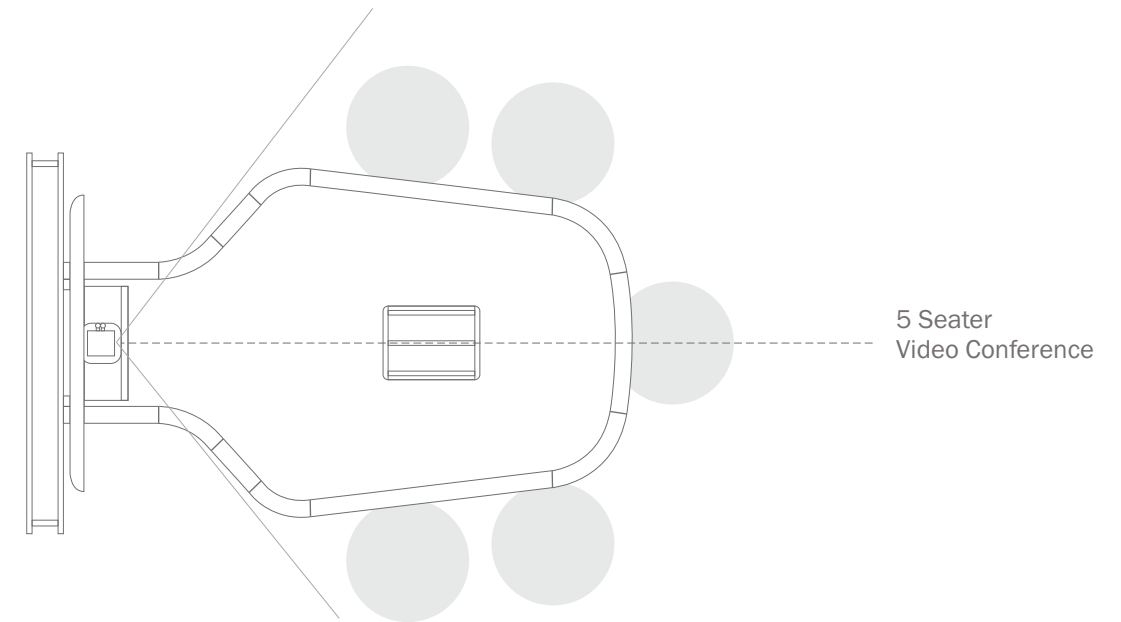

Dimensions (in mm)

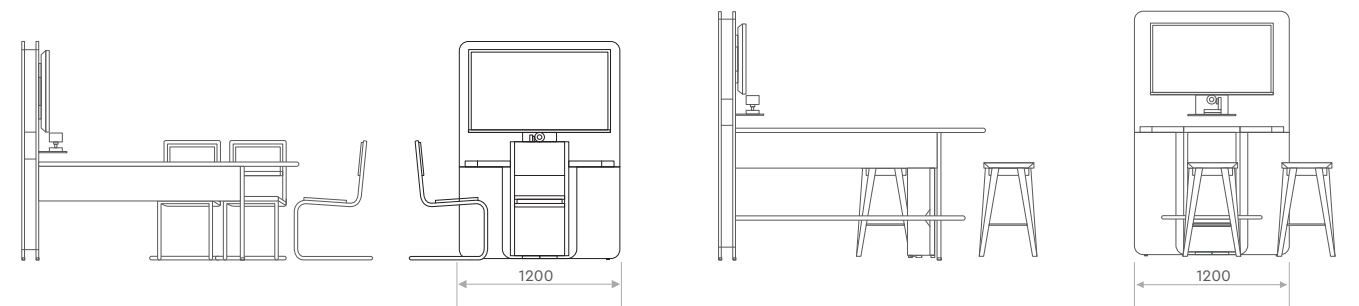

Color options

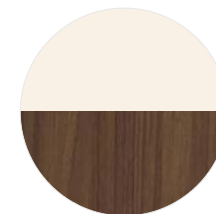

Nova Magnolia + Noce Versailles

MINGLE UNITIZED

Great teams constantly collaborate and improvise.

Whether it is an internal project review or a first meet with an external team, the right ambience can lift your discussions to a whole new level. The impressive Unitized range of conference tables brings AV technology, easy collaboration and seamless teamwork, quite literally, to the table. Making it ideal for detailed discussions, reviews and extended video conferences.



Length to width ratio ensures optimal screen viewing

Integrated AV systems for a sleek look

Understructure designed for ample leg space

Registered Design No:
316649-001, 316649-002

Features



Integrated cable retractor to enable cable back into worktop at push button



Easy access of Charging and AV points



Clutter free top with sleek design



Unique understructure to give ample leg space



Designed to ensure optimal screen viewing angle

AV Upgrades (2100 | 2350 | 3000)

Cable Cubby



Extron 2 Nos.

Below mentioned configuration is for tables having up to 2 sets of presentation points on table.

Cubby Fittings

Part	Description	Qty.
Cable Cubby	Extron Cable Cubby	2 Nos.
AC outlet	Dual Power socket	2 Nos.
Cable Retractor Bracket Kit	Cable Retractor bracket kit	2 Nos.

Cable Retractors: Extron Retractors



1 No. HDMI Retractor + 1 No. VGA-A Retractor
Or
2 Nos. HDMI Retractor



Network Retractor
2 Nos.

Transmitter & Receiver Set for AV signals with Cables, Patch code and Accessories



2 Transmitters & 2 receivers

Cable & Connectors kit:

- 30 m DTP Twisted pair Signal extension cables with connectors
- 2m HDMI High speed cable: 2 Nos.

AV Upgrades (3600 | 4200)

Cable Cubby



Extron 2 Nos.

Extron 1 No.

Below mentioned configuration is for tables having up to 3 to 4 sets of presentation points on table.

Cubby Fittings

Part	Description	Qty.
Cable Cubby	Extron Cable Cubby	2 Nos.
Double side Cable Cubby	Extron Double sided Cable Cubby	1 No.
AC outlet	Dual Power socket	4 Nos.
Cable Retractor bracket kit	Cable Retractor bracket kit	4 Nos.

Cable Retractors: Extron Retractors



1 No. HDMI Retractor + 1 No. VGA-A Retractor
Or
2 Nos. HDMI Retractor



Network Retractor
4 Nos.

Transmitter & Receiver Set for AV signals with Cables, Patch code and Accessories



2 Transmitters & 2 receivers

Cable & Connectors kit:

- 60 m DTP Twisted pair Signal extension cables with connectors
- 2m HDMI High speed cable: 4 nos.

Common note for AV upgrades of all 5 tables

Note: Display should have minimum 2 HDMI ports. AV switcher and AV control system will be required to connect more than 2 presentation points to display and it is not part of standard offering.

Dimensions

PLT & Membrane Range

	2100 x 1150 mm	2350 x 1150 mm	3000 x 1150 mm	3600 x 1500 mm	4200 x 1500 mm
No. of Seats	6	8	10	12	14

AV Range

	2100 x 1150 mm	2350 x 1150 mm	3000 x 1150 mm	3600 x 1500 mm	4200 x 1500 mm
No. of Seats	6	8	10	12	14

Color options

PLT Range



Siam teak



Palau teak

Membrane Range & AV



Tobacco Ash



Verade Oak Soft Natural

MINGLE ELEGANCE

Thoughtfully created for businesses of future.

With video conferences and tech-led meets becoming the norm, having conference spaces that ensure complete visibility and communication around the table is important. Elegance provides a modular system with the latest in AV integration at your fingertips - facilitating seamless interactions between people and quick exchange of ideas and thoughts through collaboration.



Unobstructed view of screen and audience

Smart space optimization solutions

Modular format for distinctive workspaces

Registered Design No: 317042-002

Features



Integrated cable retractor to enable cable back into worktop at push button

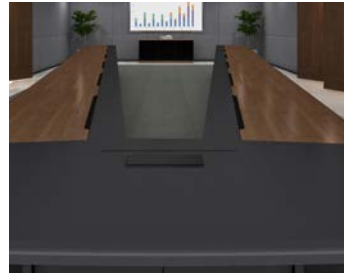

Clutter free table top with sleek design



Full Length access flap for easy access of Power and Data connectivity



Unique module designed to give ample leg space

Modules

Straight Modules



Straight (Main/Shared/End LH & RH) 2 seater



Straight (Shared) 1 seater

Corners for V-Shaped layouts



V1 Head Module
1 - 3 seater



V1 Corner
1 seater



V2 Head Module
1 - 3 seater



V2 Corner
1 seater

Corners for Rectangular layouts



H1 Head Module
3 - 4 seater



H2 Head Module
4 - 5 seater



Corner Module
2 seater

Possible Configuration

Open Layout



H1 Head Module



H2 Head Module

Closed Layout



H1 Head Module

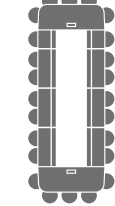

H2 Head Module

Open Layout



Layout using V1 and V2 Head Module

Closed Layout



Closed Layout using Corner Module

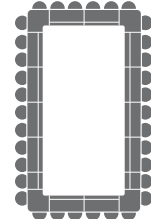
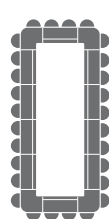

Open Layout using Corner Module

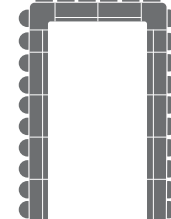
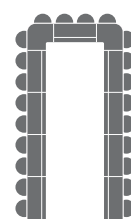

AV Upgrades for Head Modules with Cable Cubby

Below mentioned configuration is for tables having up to 3 to 4 sets of presentation points on table.

Cable Cubby



Extron 1 No.

Cubby Fittings

Part	Description	Qty. per cubby
Cable Cubby	Cable Cubby	1 No.
AC Outlet	Dual Power Socket	1 No.
Cable Retractor Bracket Kit	Cable Retractor Bracket Kit	1 No.

Cable Retractors: Extron Retractors



Part	Qty. per cubby
HDMI Retractor	1 No.
Display Port Retractor	1 No.
VGA - A Retractor	1 No.
Network Retractor	1 No.

Transmitter & Receiver Set for AV signals with Cables, Patch code and Accessories



AV Signal Transmitter and Receiver

Cable & Connectors kit:

- 20 m DTP Twisted pair Signal extension cables with connectors
- 2 m HDMI High speed cable: Qty 1 no.

AV Upgrades for Main, Shared, End and Corner modules

HDMI signal booster and Long HDMI cable



Cable & Connectors kit:

- 10 m Pro series HDMI cable: 1 No.
- 2 m HDMI High speed cable: 1 No.

Note : Display should have minimum 2 HDMI ports. AV switcher and AV control system will be required to connect more than 2 presentation points to display and it's not part of standard offering.

Accessories



Two Way Name Plate



Document Shelf



HDMI Wire Cover

Color options

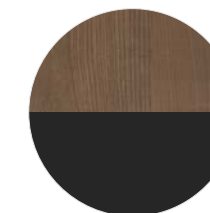

Tobacco Ash + Orchidea Nera Supermatt

MINGLE MODULAR

**Create space at the table.
More minds. More ideas.**

Flexibility, technology and the ability to quickly adapt to changing needs make up the conference room experience today. With corporate needs evolving constantly, Mingle Modular makes it easy for dynamic businesses to add independent table modules from this offering.



Freedom of choice to customise configurations as required

Cantilevered design for unobstructed leg room

Registered Design No: 316649-004, 316926-001, 316926-002, 317042-001

Features



Cable holder for easy access of cable and keeping cables tangle free



Clutter free top with provision of Power Module at bottom



Unique module designed to give ample leg space

Modules

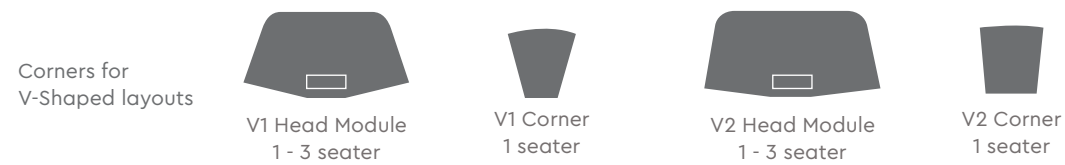

Possible Configuration

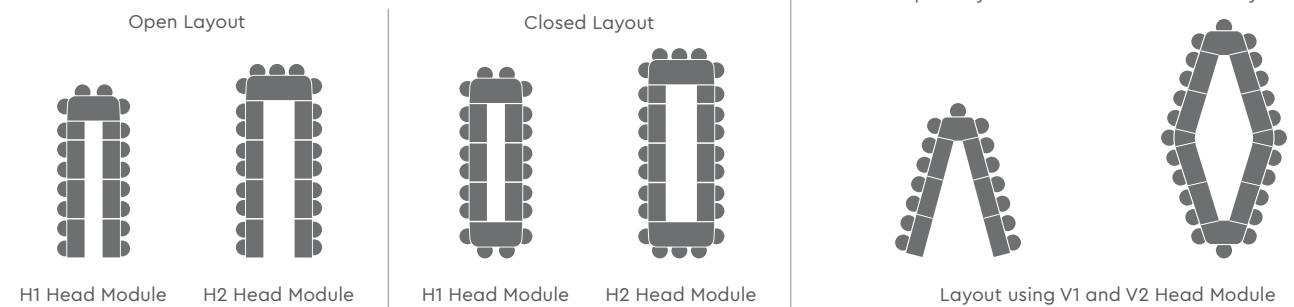

Closed Layout using Corner Module

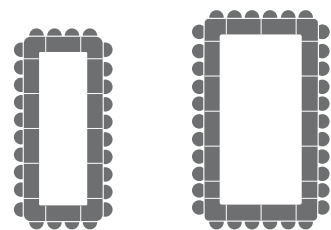

Open Layout using Corner Module

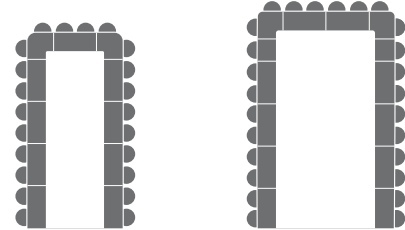

Accessories



Two Way Name Plate



Document Shelf



HDMI Wire Cover



HDMI Holder

Color options

PLT Range



Siam Teak



Palau Teak

Membrane Range



Amati PC



Verade Oak Soft Natural

MINGLE GATHER

Fresh thinking needs a fresh setting.

This bold, no-fuss community table sets the tone for engaging, informal sessions of co-creation, brainstorming, reviews and lots more! High seating makes interaction more active by encouraging employees to stand, change their posture, and in the process, refresh their thinking. In-built cabling makes using laptops and tablets easy without compromising the workspace on the table top.



Open Community Space assists in multiple work and casual settings

Helps build a culture of choice at workplace

Elegant contemporary aesthetics

Registered Design No: 317042-003

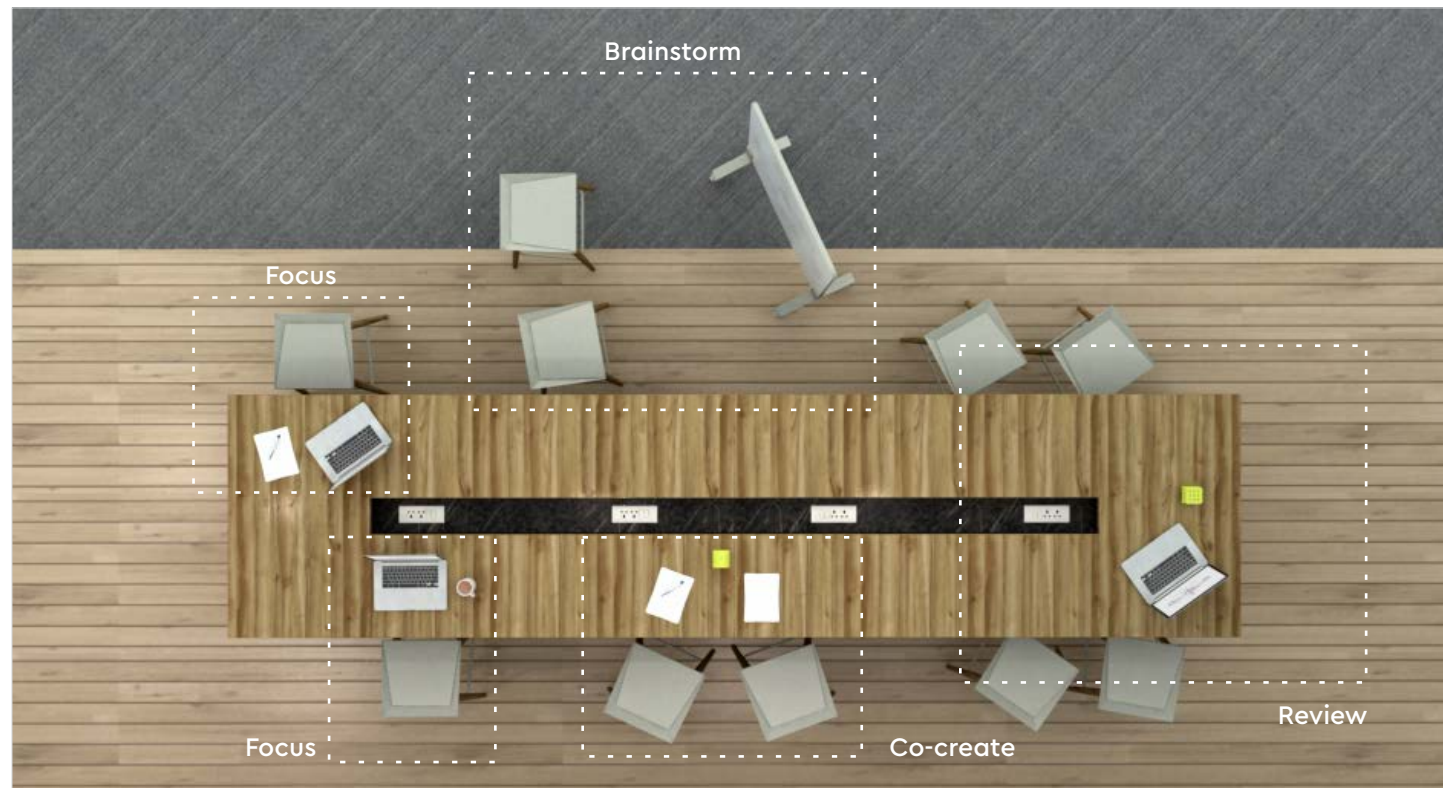

Features



Contemporary design and aesthetics



Central power module gives easy access to Power and Data connectivity

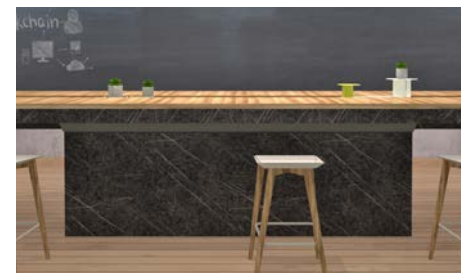

Unique understructure with concealed wire management

Accessories

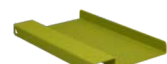

Mini-tray



Mini-mushroom



Mushroom



Pantry Stand



Pencil holder



Mini-stand

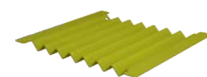

Zig-zag tray

Dimensions (all dimensions in mm)

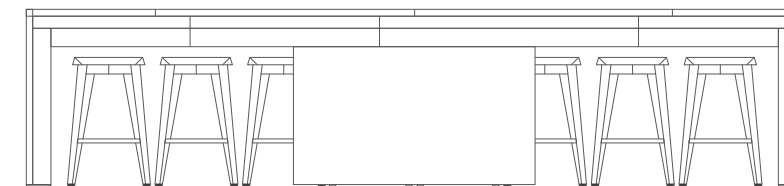
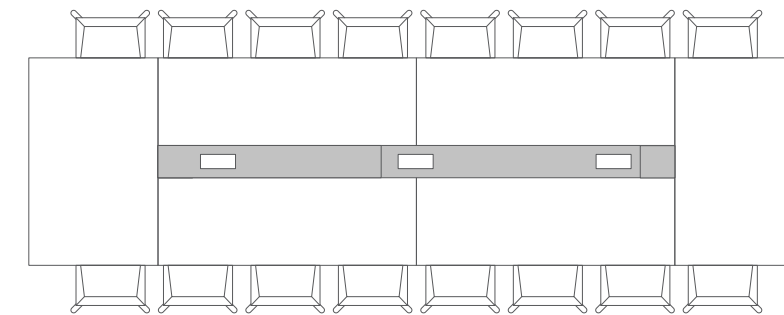

Size	L	W
4 Seater	2300	800
10 Seater	3200	1200
16 Seater	5000	1200

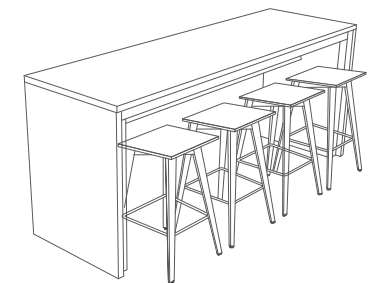

Color options

PLT Range

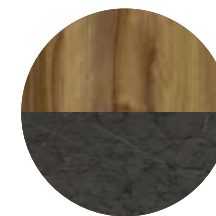

Rimini Walnut + Greystone Dark

Membrane Range

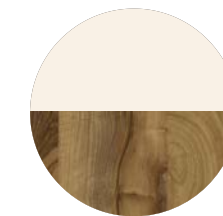

Nova Magnolia + Rimini Walnut

MINGLE POD

Where team members challenge each other to do better!

At times, brainstorming and innovative thinking is best done in small groups. A small group means better and quicker interaction. The formal boardroom can make people feel lost, while the office lounge may be too casual. Mingle POD creates ideal Huddle spaces with closeness and comfort that keeps conversation and ideas flowing.



Seamless AV upgrade available

Complement by side tables & Social seating

Transform creative to collaborative workspace

Registered Design No: 316419-001



Features



Unique understructure with concealed wire management



Clean top with cable cubby for Power supply

AV Upgrades



With under desk mounting kit

Cable & Connectors kit:

- 15 m Signal extension cables with Connectors
- 2 m HDMI High speed cable: 2 Nos.

Dimensions (all dimensions in mm)

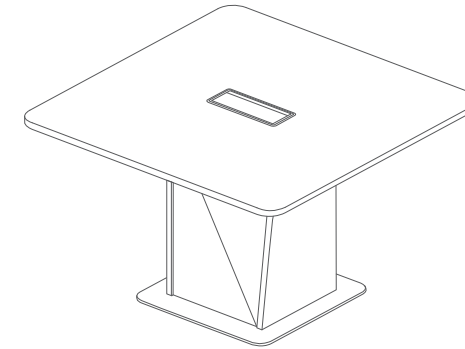

1000 W X 1000 L
1150 W X 1150 L

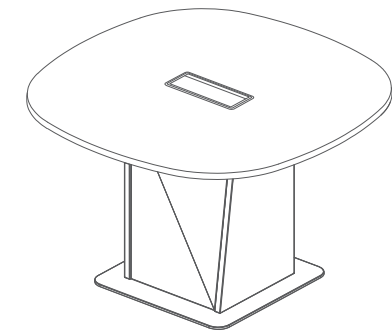

1000 (Dia)
1150 (Dia)

Color options



MINGLE
AV STORAGE UNIT



Registered Design No: 317042-005

The Perfect Side Storage Solution

The Mingle AV Storage unit is thoughtfully designed to subtly blend into any conference room with availability in matching laminates of all tables. Specially designed for storing Audio Visual equipment.

Dimensions (all dimensions in mm)

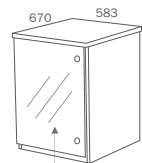

Tinted Glass Door

Accommodate 12U rack - 1 No.

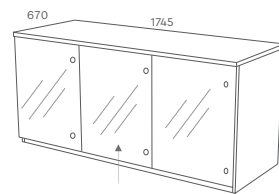

Tinted Glass Door

Accommodate 12U rack - 3 Nos.

Color options

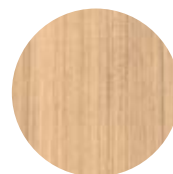

Siam Teak



Palau Teak

Conference spaces
create corporate
cultures.
Make yours inspiring!