



Office Furniture

Modular Workstation, Desking, Seating, Storage, Social Office and more

Workplace Solutions With A Home-like Comfort



With Godrej Interio range of workplace solutions, you can achieve just that and more.

Be it seating, desking, storage, or modular workstations, our state-of-the-art manufacturing processes ensure that every piece of furniture we craft, meets our high standards of comfort and yours.

An effective work environment ensures maximum productivity, while offering utmost comfort. The name of the game is to make the time spent at the desk, not feel like time being spent at the desk. **Because who says you can't make space for life, even as you go about making your livelihood.**



Partnering India In Building A Better Tomorrow.

We are India's largest home & institutional furniture manufacturer since 1936. With a focus on Make in India products, manufactured in state-of-the-art facilities meeting global design, quality and test standards.

Supporting modern nation-building with products, services and initiatives geared towards a greener, healthier, progressive and prosperous future.



125 Years Of Legacy. 1000+ Projects Delivered Annually.

With a rich legacy that spans over 125 years, Godrej is a pioneer across industries in India.

Led by India's largest in-house furniture design team, our aim is to transform spaces with thoughtfully-designed furniture. And our goal is to create brighter homes and offices with products that have the highest design quotient in aesthetics, functionality, and technology.

Godrej Interio at a glance

- India's largest home & institutional furniture manufacturer, since 1936; supporting nation building
- 95% ex-works TOC performance through project tools and dedicated team to ensure on-time project delivery
- Unique customization capabilities
- Winner of 34 India Design Mark Awards till date

Widest product portfolio across product lines

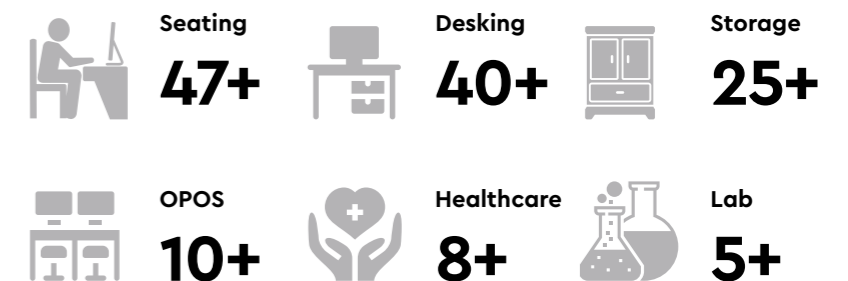

Enforcing Green At Every Step

At Godrej Interio, our sustainability goals are ambitious. We do not just talk, we walk the talk.

We take our work seriously because we know our products and services touch people, transform lives and change the world.

When we add the element of sustainability and green living into what we do, it adds the positivity of hope to the promise of a better future, not only for people but for the planet as a whole.

godrej interio
talk green.
walk green.



Materials

- Design For Environment
- Green Materials
- LCA



Transportation

- Green Modes Of Transportation



Manufacturing

- Energy Efficiency
- Zero Waste Water Discharge
- Renewal Energy
- Zero Waste Landfill



In Use

- Low Emitting Products
- Green Certification
- AMC



Packaging

- Flat Packaging
- Right Packaging



End Of Life

- Recycling Program
- Safe Disposal

India's First Net Zero Energy Building.

- CII certified state of the art manufacturing facilities across 6 locations
- Designed for the environment: Cradle to grave journey monitored



Greeneco certifications awarded to Vikhroli and Shirwal Units

Largest Portfolio of Certified Products



128+
Green Pro



59+
Green Guard



37+
GRIHA



18+
BIFMA Level 2



18+
SCS Indoor Advantage Gold

Towards Healthier Workspaces

godrej interio
wellness@work

- Team of certified doctors / ergonomists to assist employee health and productivity challenges at workplace

- Initiatives help reduce healthcare cost

- Ergonomics Program helps organizations improve employee comfort, lowers injuries arising out of sedentary lifestyle at work

- Team is backed by research and advisory experience spanning across corporate, government and healthcare organizations

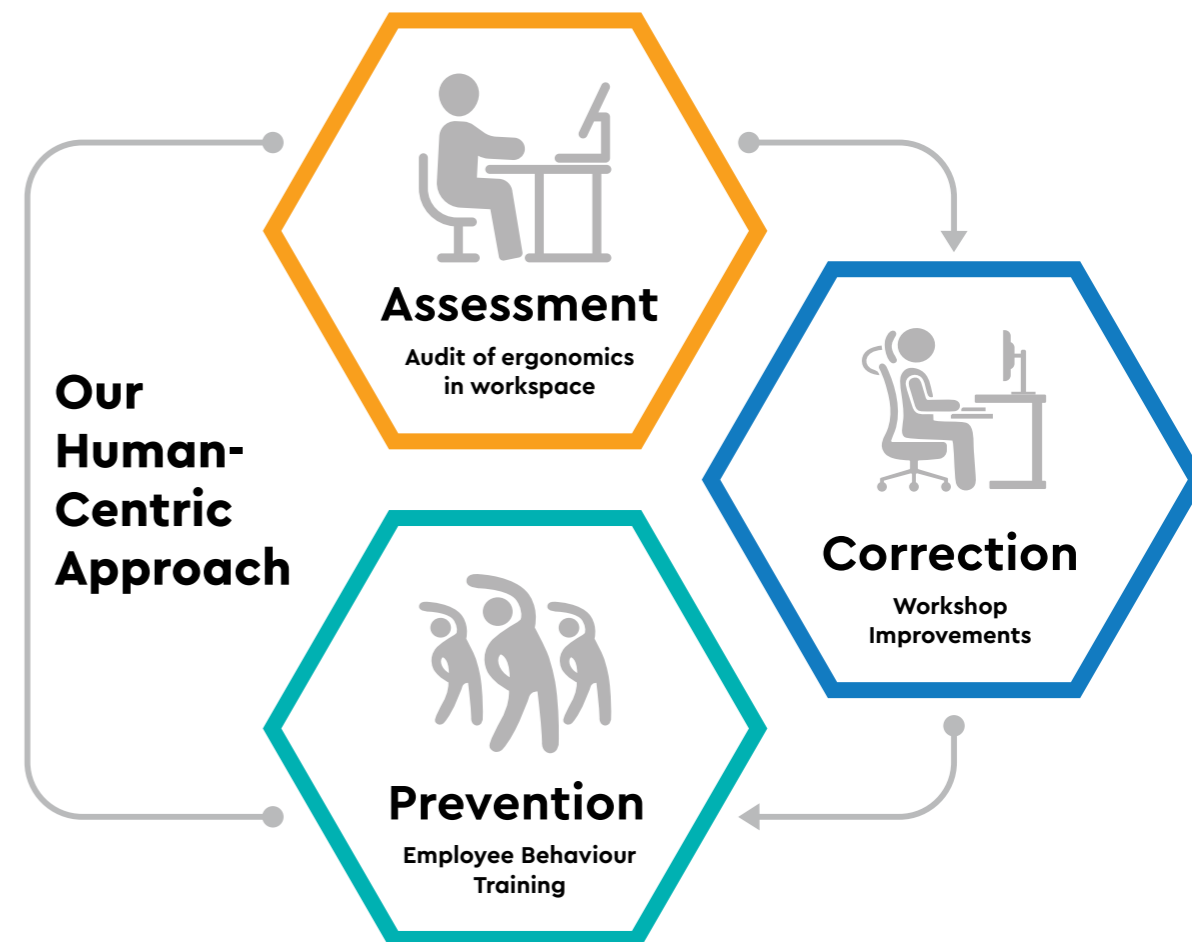

SPECTRUM

THE COLOUR EXPERIENCE

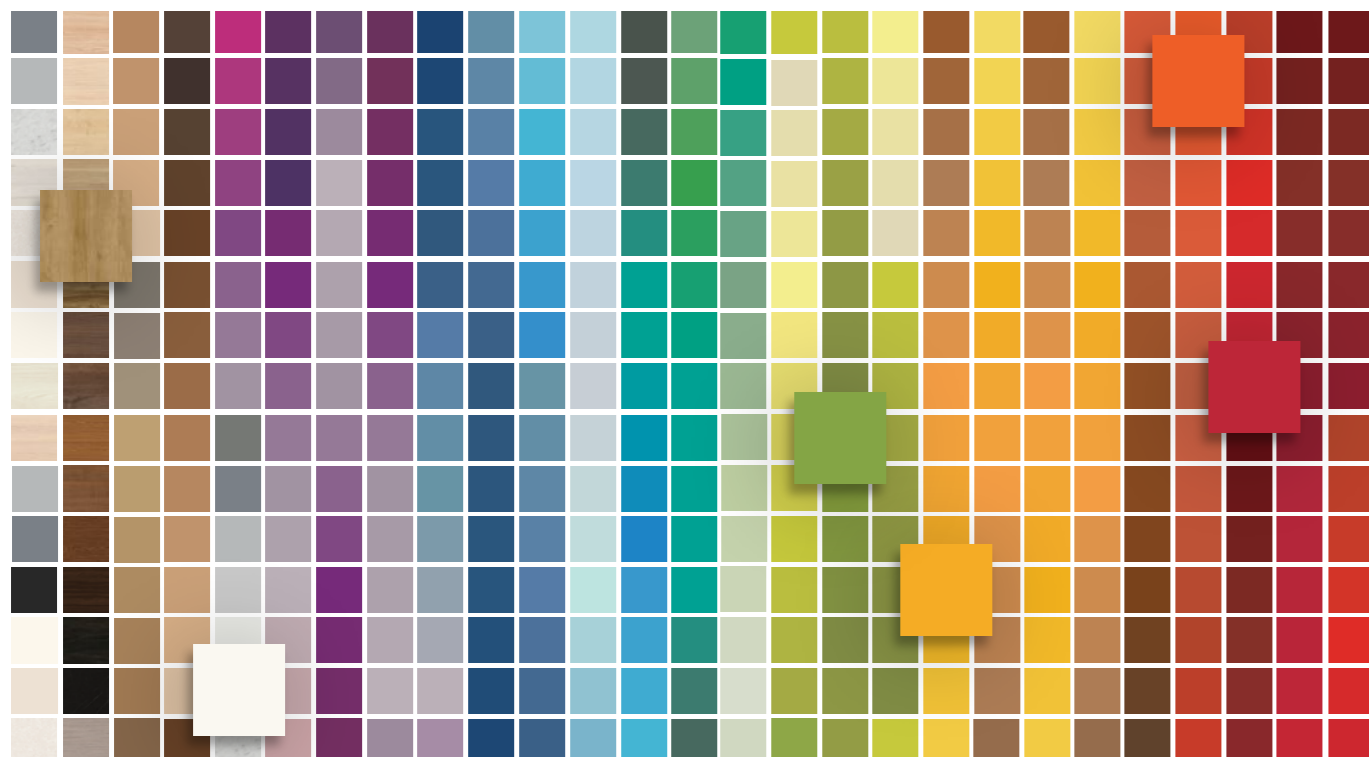

A 21st century workspace calls for environments that are conducive to superior productivity, that inspire learning and evoke creativity.

SPECTRUM by Godrej Interio brings together emerging trends and insights in a comprehensive range of colour shades to aid in creating fresh and inspiring workplaces.

Curated Colour Palettes

Backed By Trends Forecast Research



SPECTRUM showcases an array of colours, materials and finishes such as Laminate, Membrane, Metal, Glass, Fabric, Leather & Leatherette suited to dynamic contemporary work cultures.

Further in this dossier, a dedicated section called SPECTRUM offers a broad view on Indian lifestyle through indicative use cases – to help decision makers in designing a customised palette for their office space that's in sync with their organisation's vision, mission and culture.

Connect with our Business Representative to know more

Theme: Breathe



Theme: Secure

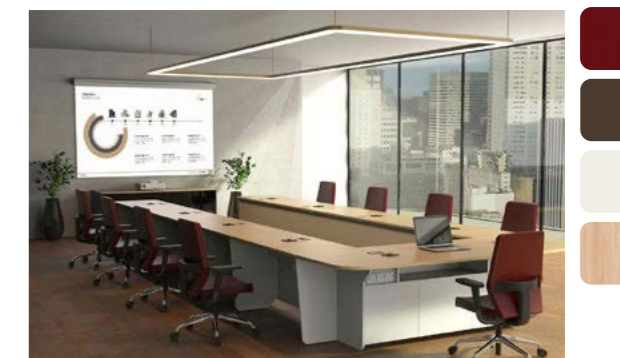

Theme: Culture

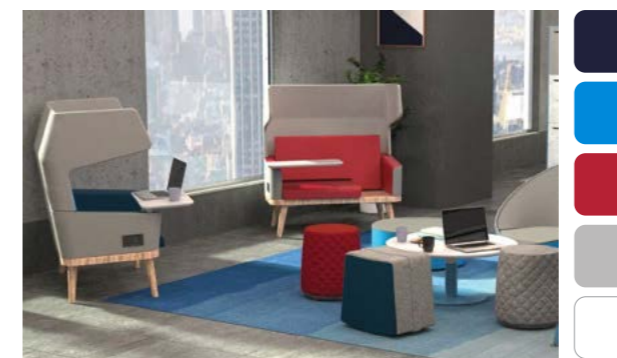

Theme: Splendor



Turning Space Into An Interior Turn-key Solution



Godrej Interio 360 degree interior solutions handle everything from scratch to finish. Using our extensive understanding of workplace strategies, we are able to provide tailor-made solutions for 1500+ projects.



What We Deliver

- On-time delivery
- Innovative design solutions combine fine aesthetics with smart ergonomics
- No compromise in quantity
- Gamut of services from civil work to interior designing to HVAC to electrical jobs to security systems to LAN and data cabling to video conferencing installation



- **900+** Network of B2B dealers and service partners
- **4** B2B Display Centres
Pune • Bengaluru • Delhi • Chennai
- **6** Experience Centres
Delhi • Mumbai (2) • Kolkata • Hyderabad • Chandigarh
- **1** Knowledge Centre
Mumbai

Our All India Presence

Get complete access to our wide range of workplace solutions across our 900+ dealers and partners in India. Manufactured at our facilities in Vikhroli, Shirwal, Khalapur, Haridwar, and Bhagwanpur, all our workplace products pass through multiple stringent quality checks before they reach you.

Storage

Page 135
Aisle and Back Storage

Page 150
Personal Storage

Page 156
High Density Storage

Page 145
Display Storage

Page 154
Conventional Storage

Mobile Caddy



Features

- The Mobile Caddy's complete knock-down construction enables customised arrangements for different work situations.
- It's ideal for both teams and individual requirements.
- Comes with lockable castors for outer body, and an anti-tilt castor for the pedestal, thereby ensuring flexibility and overall stability.
- Available in TDU+RH Drawer or TDU+LH Drawer configurations.

Measurements

Mobile Caddy LH

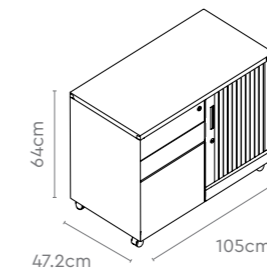

Mobile Caddy RH

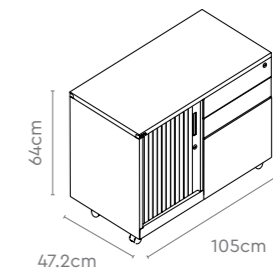

Colour & Material

POWDER COAT



All sizes in cm	Width	Depth	Height
Mobile Caddy	105.0	47.2	64.0

Cell Phone Lockers

Features

- The Cell Phone Locker comes in two variants: 30-door Wall Mounting and 60-door Wall Mounting or Standalone (with aluminium base).
- Comes with a 180 degree opening door for more convenience, and is available in a fully assembled construction.
- Ideal for workspaces with limited wall space.
- Can be used to store cell phone, wallets and other day-to-day valuables, be it at a school, office, or at home.



Colour & Material

POWDER COAT



Measurements

30 Door Locker Wall Mounted

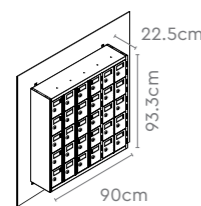

60 Door Locker Wall Mounted

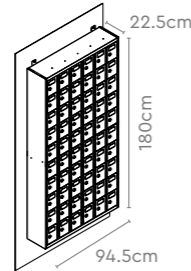

60 Door Locker Stand Fixed

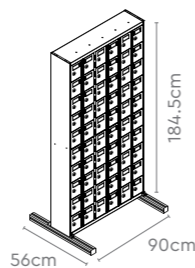

All sizes in cm	Width	Depth	Height
30 Door Locker Wall Mounted	90.0	22.5	93.3
60 Door Locker Wall Mounted	90.0	22.5	180.0
60 Door Locker Stand Fixed	94.5	56.0	184.5

Reserve

Features

- Individual units which are an ideal fit for aisle-side storage and back units.
- Seamlessly integrate multiple units. Available in LH and RH options, enabling versatile configurations.
- Shared units, used between end units help create optimum storage spaces for all your needs.
- Available with legs as well as skirting options so that you can combine them with your workstation easily.



Colour & Material

POWDER COAT

METAL BODY

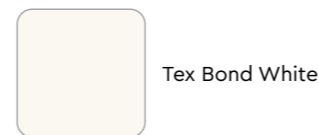

LAMINATE RANGE

WOODEN SHUTTER

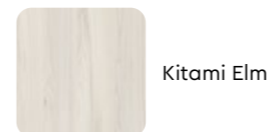

Measurements

LFC with Skirting

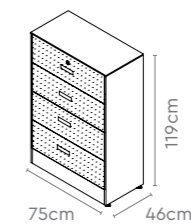

LFC with Legs

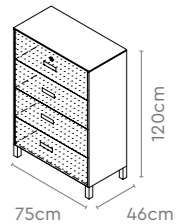

HDU with Skirting

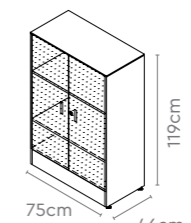

HDU with Legs

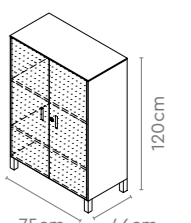

All sizes in cm	Width	Height
LFC with Skirting	75.0/80.0/90.0/95.0/100.0/105.0	75.0/119.0/134.3
LFC with Legs	75.0/80.0/90.0/95.0/100.0/105.0	75.0/120.0/135.3
HDU with Skirting	45.0/60.0/65.0/75.0/80.0/90.0/95.0/100.0/105.0/120.0	75.0/119.0/134.3
HDU with Legs	45.0/60.0/65.0/75.0/80.0/90.0/95.0/100.0/105.0/120.0	75.0/120.0/135.3

Tambour Door Unit



Features

- Tambour's doors roll inwards, preventing blockage of space while in use.
- Adds to the aesthetics of your space, thanks to its translucent double shutters.
- Comes with central locking for optimal security.
- Can be paired with a wide range of accessories as per your needs.

Measurements

TDU - Variant 1

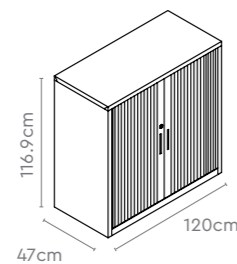

TDU - Variant 2

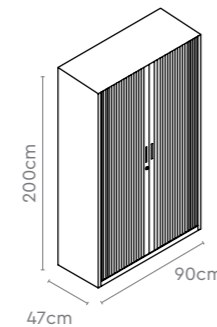

Colour & Material

POWDER COAT

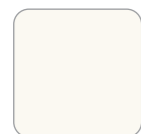

Tex. Bond White

All sizes in cm	Width	Depth	Height
TDU	75.0	47.0	69.0/116.9
	90.0	47.0	69.0/116.9/200.0
	120.0	47.0	69.0/116.9/200.0

Cushion LFC

Features

- The precision telescopic slider mechanism makes the drawer movement effortlessly smooth.
- An anti-rebound mechanism helps prevent the drawer from coming out after it is pushed in.
- Comes with an anti-tipping mechanism that allows only one drawer to be opened at a time, helping prevent the cabinet from toppling over.
- Comes in wooden top and metal top. Available with two, three and four-drawer options.
- 100% VOC-free powder coating.



Colour & Material

POWDER COAT & LAMINATE

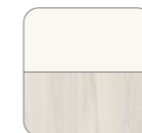

Tex. Bond White & Kitami Elm

POWDER COAT

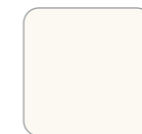

Tex. Bond White

Measurements

Metal

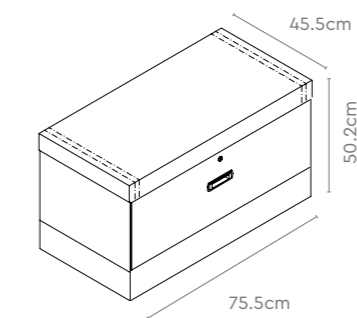

Wooden

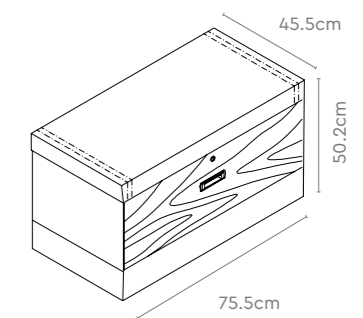

All sizes in cm

Metal & Wooden

Width

Depth

Height

75.5

45.5

50.2

Vertical Filing Cabinet

Features

- The precision telescopic slider mechanism makes the drawer movement effortlessly smooth.
- An anti-rebound mechanism helps prevent the drawer from coming out after it is pushed in.
- Comes with an anti-tipping mechanism that allows only one drawer to be opened at a time, helping prevent the cabinet from toppling over.
- Comes in three colour swatches and two drawer options.



Colour & Material

POWDER COAT



Measurements

2 Drawer VFC

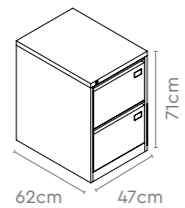

4 Drawer VFC

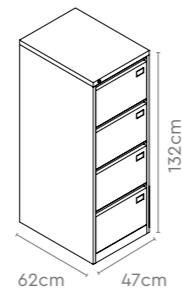

All sizes in cm	Width	Depth	Height
2 Drawer VFC	47.0	62.0	71.0
4 Drawer VFC	47.0	62.0	132.0

Lateral Filing Cabinet

Features

- The Lateral Filing Cabinet is a minimalistic and sturdy storage option that enables easy access to all your files at one go.
- Ideal for aisles, it comes with anti-tipping and anti-rebound mechanisms to ensure maximum user safety.
- Available in two sizes and drawer configurations to meet all your needs.



Colour & Material

POWDER COAT



POWDER COAT & LAMINATE

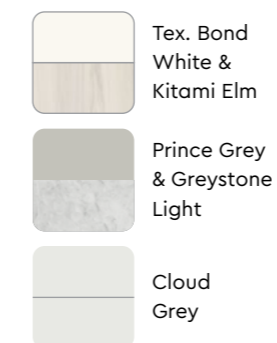

Measurements

2 Drawer LFC (with Metal Top)

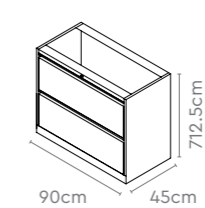

4 Drawer LFC (with Metal Top)

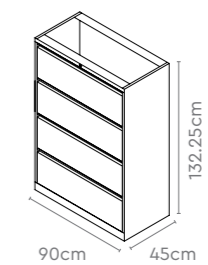

All sizes in cm	Width	Depth	Height
2 Drawer LFC (with Laminate Top)	90.0	45.0	737.5
2 Drawer LFC (with Metal Top)	90.0	45.0	712.5
4 Drawer LFC (with Laminate Top)	90.0	45.0	134.75
4 Drawer LFC (with Metal Top)	90.0	45.0	132.25

Sliding Door Unit



Features

- Equipped with adjustable shelves that provide flexible space options for various storage needs.
- Its sliding door construction makes the most of your aisle space.
- Snap-on die-cast lock keeps it secure, while making it aesthetic.
- Comes with plastic rollers with steel ball bearings for effortlessly smooth door movement.
- Lower height units come in wooden and metal top options.

Measurements

All sizes in cm

	Width	Depth	Height
VSDU-2 (with Metal Top)	90.0	45.0	71.0
VSDU-2 (with Laminate Top)	90.0	45.0	73.5
VSDU-5 (with Metal Top)	90.0	45.0	116.75
VSDU-5 (with Laminate Top)	90.0	45.0	119.25
VSDU-6 (with Metal Top)	90.0	45.0	132.0
VSDU-6 (with Laminate Top)	90.0	45.0	134.5
VSDU-7 (with Metal Top)	90.0	45.0	183.0
VSDU-9 (with Metal Top)	120.0	45.0	71.0
VSDU-9 (with Laminate Top)	120.0	45.0	73.5
VSDU-10 (with Metal Top)	120.0	45.0	86.25
VSDU-10 (with Laminate Top)	120.0	45.0	88.75
VSDU-12 (with Metal Top)	120.0	45.0	116.75
VSDU-12 (with Laminate Top)	120.0	45.0	119.25

Sliding Door Unit

Colour & Material

POWDER COAT

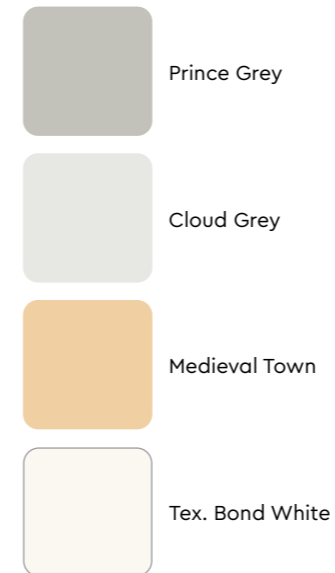

POWDER COAT & LAMINATE



Measurements

VSDU-2 (with Metal Top)

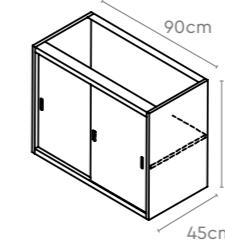

VSDU-5 (with Metal Top)

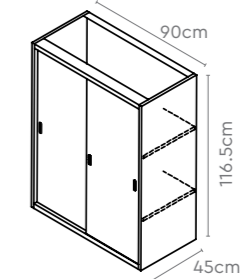

VSDU-6 (with Metal Top)

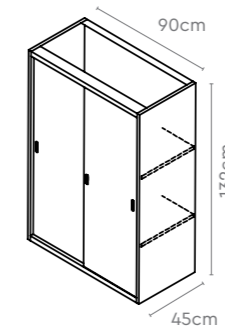

VSDU-7 (with Metal Top)

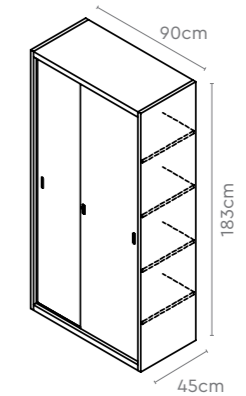

VSDU-9 (with Metal Top)

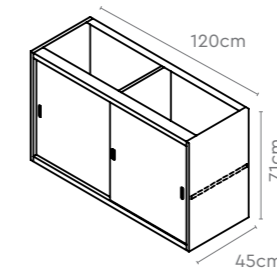

VSDU-10 (with Metal Top)

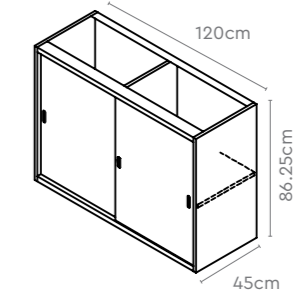

VSDU-12 (with Metal Top)

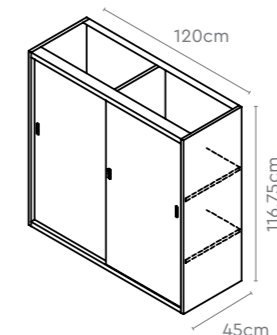

Store Up



Features

- The Store Up is aesthetically appealing, hassle-free, and ergonomically designed.
- Optimally uses corner spaces while providing ample storage.
- Can be installed in an unending line up with no limit to the number of main plus add-on bodies.
- Made of a sturdy metal carcass structure.

Measurements

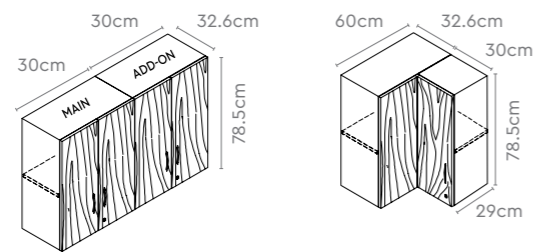

Colour & Material

POWDER COAT & LAMINATE

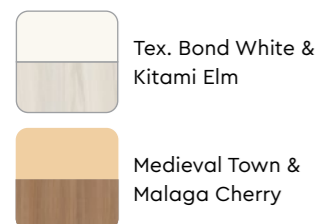

All sizes in cm	Width	Depth	Height
Store Up	30.0/45.0/60.0/80.0/90.0	32.6	78.5

Gain Pro Display Unit

Features

- This display unit has an extensive storage capacity for books, records, files, etc.
- Its minimal style makes it an aesthetic addition to any workspace.
- Being extremely adaptable from floor-to-ceiling and wall-to-wall, it can optimise any space big or small.
- Its versatile modules can be configured as clusters, standalone units or in custom combinations to cater to all your storage needs.



Colour & Material

POWDER COAT



Measurements

Glass Door



Combi Door



Proportion

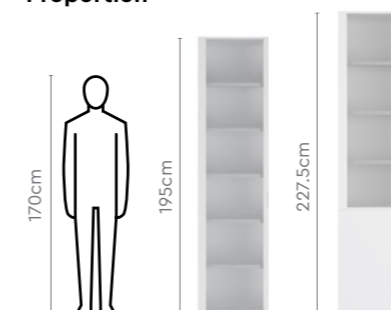

All sizes in cm	Width	Depth	Height
Glass Door	45.0/60.0/90.0/120.0	45.0	195.0/227.5
Combi Door	45.0/60.0/90.0/120.0	45.0	227.5



Design Registered

Radiance



Features

- The Radiance bookshelf is a perfect fit for modern-day libraries, clutter-free break rooms, and savvy media centres.
- It offers a better uniformly distributed load holding capacity per shelf.
- Accessories like the roll-out tray, book separators and name tags provide an enhanced document management experience.
- Its sleek aesthetics complement large and cosy spaces with equal ease and grace.
- Comes with a roll-out tray for better browsing experience.

Measurements

Wall-sided Unit SR1



Wall-sided Unit SR3

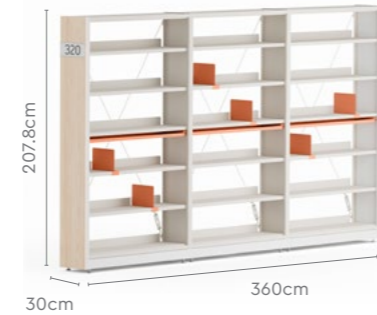

Wall-sided Unit SR2



Wall-sided Unit SR4

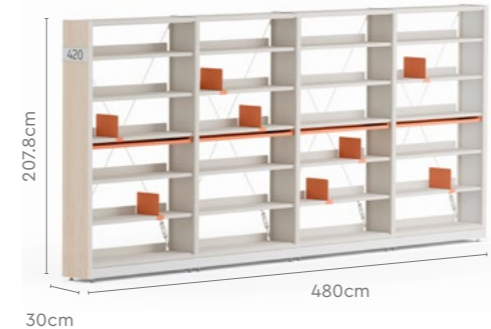

Radiance

Colour & Material

LAMINATE

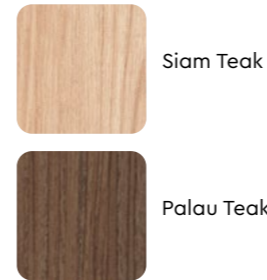

METAL

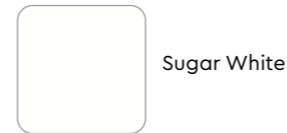

Measurements

Wall-sided Unit DR1



Wall-sided Unit DR3



Wall-sided Unit DR2



Wall-sided Unit DR4

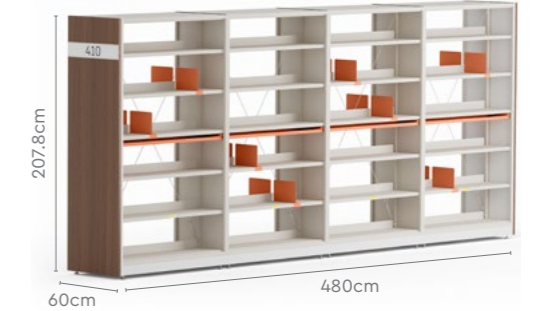

All sizes in cm

	Width	Depth	Height
Wall-sided Unit SR1	120.0	30.0	207.8
Wall-sided Unit SR2	240.0	30.0	207.8
Wall-sided Unit SR3	360.0	30.0	207.8
Wall-sided Unit SR4	480.0	30.0	207.8
Double-sided Unit DR1	120.0	60.0	207.8
Double-sided Unit DR2	240.0	60.0	207.8
Double-sided Unit DR3	360.0	60.0	207.8
Double-sided Unit DR4	480.0	60.0	207.8

Periodical Display Rack (PDR)

Features

- The Periodical Display Rack is available in Main and Add-on units, with five compartments per unit.
- Each compartment is provided with a pivoted and inclined retractable tray for better display aesthetics.
- The compartment behind the tray can be used as an additional storage space.
- The units are made from prime quality CRCA Steel, complete with anti-rust treatment.
- Comes with PLB side panels for a long life and an uber-stylish appearance.



Colour & Material

POWDER COAT



LAMINATE

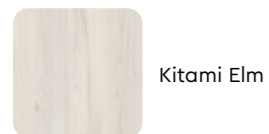

Measurements

All Steel PDR

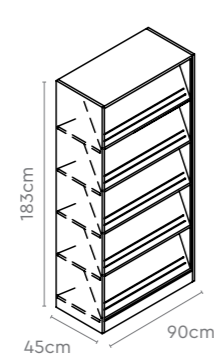

Wood and Steel PDR

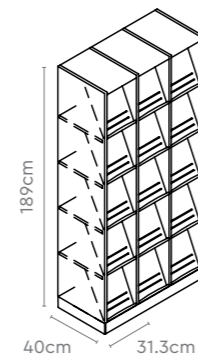

All sizes in cm	Width	Depth	Height
All Steel PDR	90.0	45.0	183.0
Wood and Steel PDR	28.8/31.3	40.0	189.0

Sliding Glass Door Unit

Features

- The Sliding Glass Door Unit saves aisle space, and forms an aesthetic backdrop to your office space.
- Adjustable shelves provide flexibility in storage layouts and type.
- Comes with aesthetically appealing snap-on die-cast lock for security.
- Plastic rollers with steel ball bearings aid smoother door movement.



Colour & Material

POWDER COAT

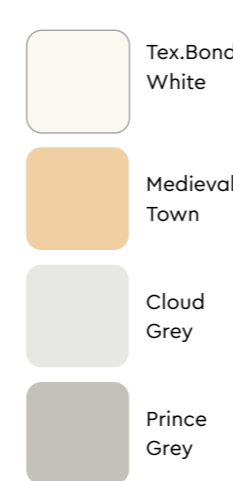

POWDER COAT & LAMINATE

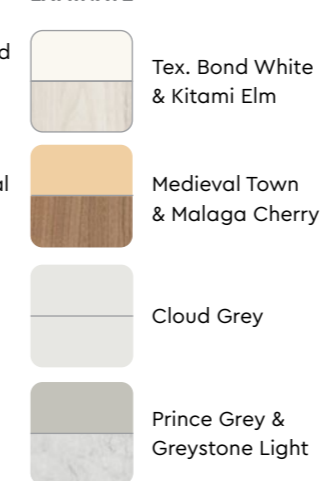

Measurements

VSDU-8 (with Metal Top)

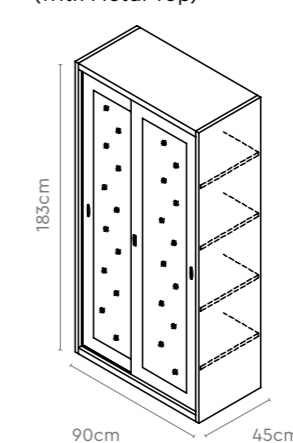

All sizes in cm	Width	Depth	Height
VSDU-8 (with Metal Top)	90.0	45.0	183.0

Gain Pro Locker Unit



Design Registered

Features

- Gain Pro lockers make optimum use of the floor space.
- It can substitute dedicated individual pedestals at each workstation. Frees up floor space substantially.
- Each locker shelf comes with a load-bearing capacity of up to 20 kgs, making it more than enough for everyday office storage needs.
- Ideal for keeping personal belongings, packages, mail, etc. Organised and secure. Also available with envelope slots.

Measurements

2 Doors without envelope slot



4 Doors without envelope slot



6 Doors without envelope slot



2 Doors with envelope slot



4 Doors with envelope slot



6 Doors with envelope slot



Proportion

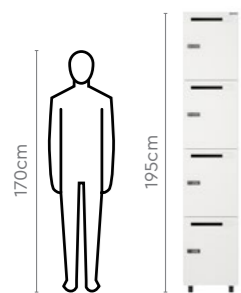

Gain Pro Locker Unit

Colour & Material

METAL

COMPLETE UNIT

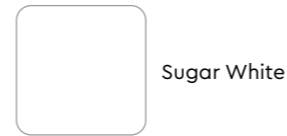

Sugar White



Gargoyle

UNIT CLUSTER



Banana Yellow

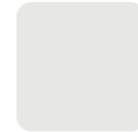

Cloud Grey



Warm Grey



Sugar White (Body)

Measurements

2 Door Unit Cluster



4 Door Unit Cluster



6 Door Unit Cluster



All sizes in cm

	Width	Depth	Height
Locker	45.0	45.0	195.0
2 Door Unit Cluster	270.0	45.0	195.0
4 Door Unit Cluster	270.0	45.0	195.0
6 Door Unit Cluster	270.0	45.0	195.0

Nova

Features

- An efficient personal storage solution that makes your work desk clutter-free.
- Available in free-standing & top-supporting options.
- Comes complete with an anti-rebound mechanism to preempt hurt, injury or damage.



Colour & Material

POWDER COAT

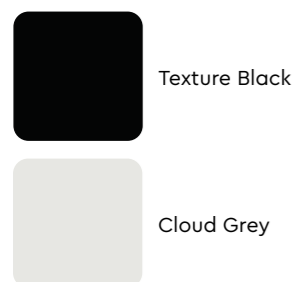

Measurements

Free Standing
BBF Pedestal

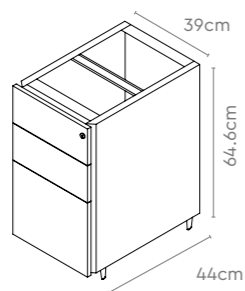

Top Supporting
BBF Pedestal

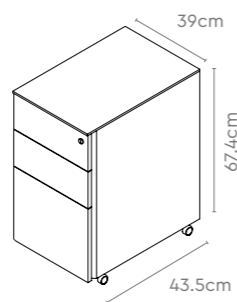

All sizes in cm	Width	Depth	Height
Free Standing BBF Pedestal	39.0	44.0/59.0	64.6
Top Supporting BBF Pedestal	39.0	43.5	67.4

Wooden PLU

Features

- These Wooden lockers have been specially designed for offices with open floor plans.
- Its aesthetic design is versatile enough to sit anywhere in your workplace.
- Comes in diverse locking systems, from traditional key based locking systems to more advanced keyless solutions, all the while providing easy access as well as high security.
- Equipped with a name plate to help you identify your personal locker easily.



Colour & Material

LAMINATE

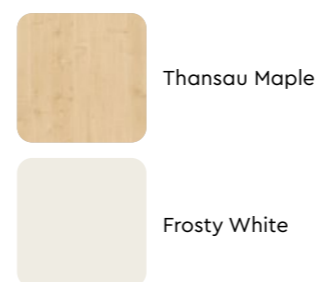

Measurements

8 Door
Main Module

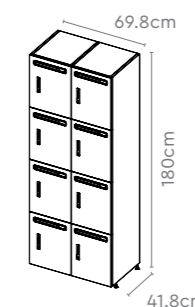

4 Door
Main Module

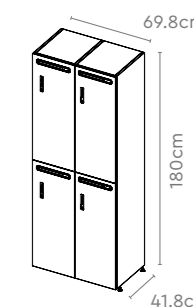

4 Door
Add On Module

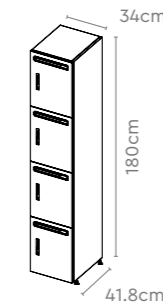

2 Door
Add On Module

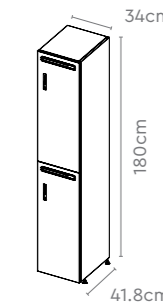

All sizes in cm	Width	Depth	Height
Main Unit	69.8	41.8	180.0
Add On Unit	34.0	41.8	180.0

KD Plain

Features

- The KD Plain provides safe and convenient storage of books, administrative files, stationery etc.
- Comes with four adjustable shelves that can store just about anything, and with a three-way bolting device for maximum security.
- Its knock-down construction makes it easy to assemble and disassemble.



Colour & Material

POWDER COAT

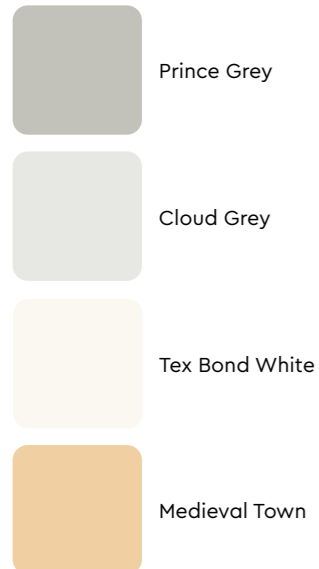

Measurements



All sizes in cm	Width	Depth	Height
KD Plain	90.0	43.0	183.0

KD Minor

Features

- The KD Minor provides safe and convenient storage of books, administrative files, stationery etc.
- Comes with two adjustable shelves that can store just about anything, and with a three-way bolting device, and a six-lever lock for maximum security.
- Its all-metal body gives it a classic look and feel.



Colour & Material

POWDER COAT



Measurements

KD Minor (with Metal Top)

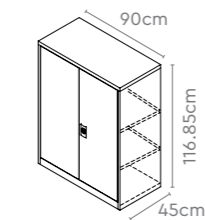

KD Minor (with Laminate Top)

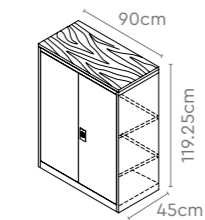

All sizes in cm	Width	Depth	Height
KD Minor (with Metal Top)	90.0	45.0	116.85
KD Minor (with Laminate Top)	90.0	45.0	119.25

Optimizer Plus

The Optimizer Plus is an intelligent mobile storage system which saves on aisle spaces unlike other storages. It comes in Push-Pull, Drive, and Power Drive options, complete with the highest standards of safety, security, and ease of use.



Power Drive



Drive



Push-Pull



Optimizer Plus

Colour & Material

POWDER COAT



Common Features



Name Tag



Adjustable Shelves



Cross Member Back Panel (Left) & Solid Back Panel (Right)

Colour & Material

POWDER COAT



Accessories

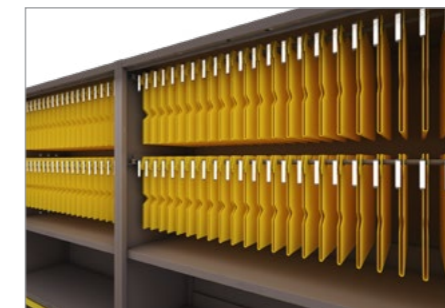

Instadex File with Cradle Pair



Rollout Shelf



Hinged Doors with Locking



Stool

Optimizer Plus

With Power Drive



Features

- Equipped with a Smart Touch Control Panel that comes with different functions such as Start, Stop, Reset and Unlock. It is placed at a suitable height for ease of access.
- Is complete with a centralised locking system that ensures maximum security to all your documents.
- A central power switch offers convenience in operation.
- Easy to install as it can be fixed directly on the ground or be embedded in the pavement, which eliminates grouting and prevents civil floor work.
- Its innovative design is in compliance with international safety standards for a better user experience.

Measurements



All sizes in cm	Width	Depth	Height
Optimizer Plus: Power Drive	120.0	40.0	198.0/ 236.1

Optimizer Plus with Power Drive

Colour & Material

POWDER COAT



Measurements

M2 Motorized with Platform

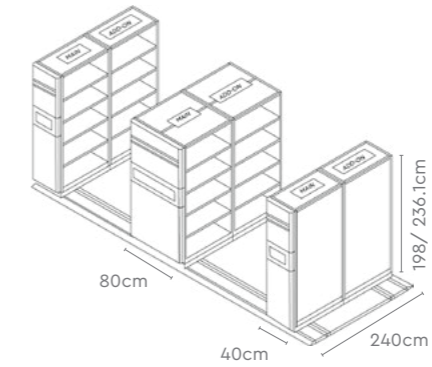

M3 Motorized with Platform

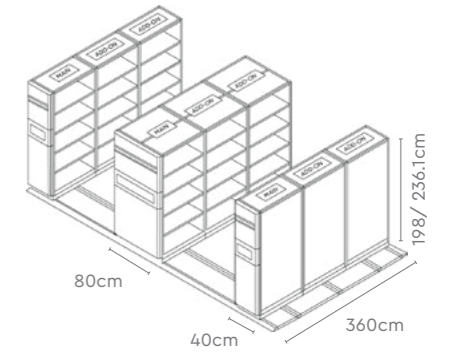

M4 Motorized with Platform

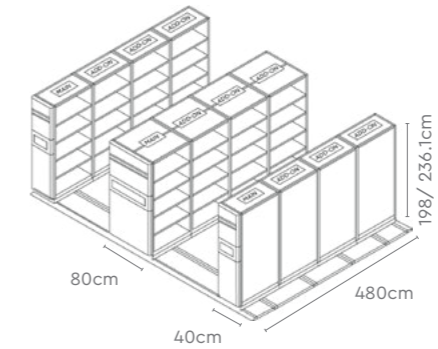

Details

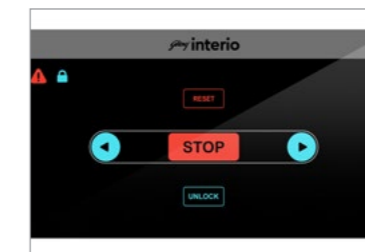

Smart Touch Control Panel



Centralized Locking

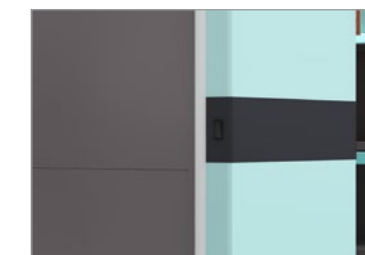

Central Power Switch

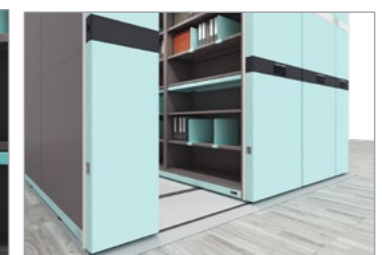

Wooden Platform

Optimizer Plus

With Drive



Features

- Drive comes with an ergonomically designed and positioned wheel that provides a firm grip for operation, while sprucing up the aesthetics of your storage area.
- Has individual locking knobs for each unit for additional safety.
- The front and rear panels are designed with perforations for ventilation.
- Is complete with a centralised locking system that ensures maximum security to all your documents.
- Easy to install as it can be fixed directly on the ground or be embedded in the pavement, which eliminates grouting and prevents civil floor work.

Measurements



All sizes in cm	Width	Depth	Height
Optimizer Plus: Drive	120.0	40.0	198.0/ 236.1

Optimizer Plus with Drive

Colour & Material

POWDER COAT



Measurements

D2 Drive Type

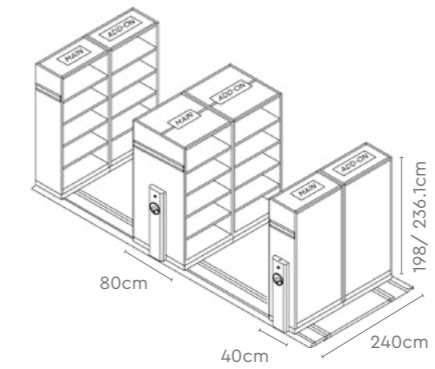

D3 Drive Type

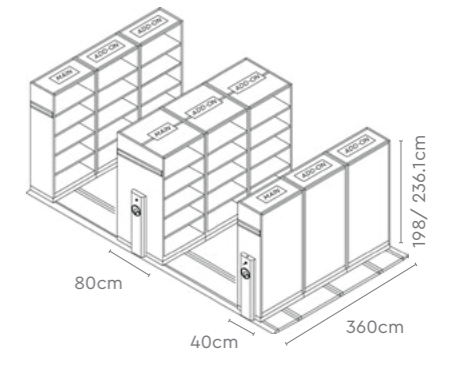

D4 Drive Type

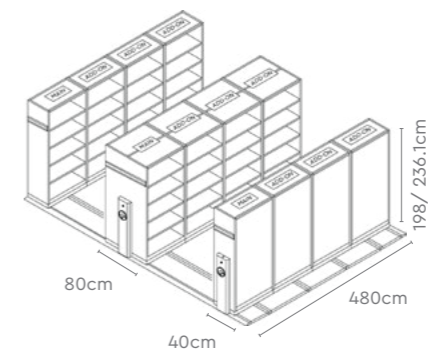

Details



Centralized Locking

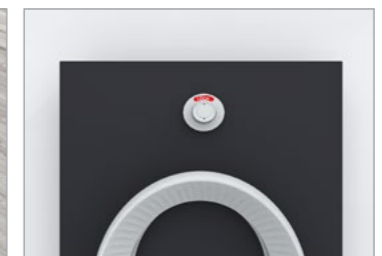

Locking Knob on Each Unit

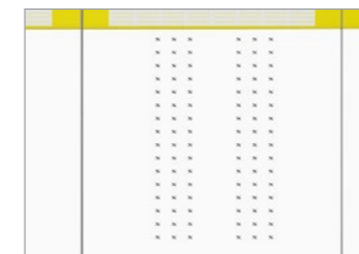

Ventilation Ready



Wooden Platform

Optimizer Plus

With Push-Pull



Features

- Push-Pull has a contemporary design that complements any indoor ambience.
- Comes equipped with C-shaped handles that minimise the effort and facilitate smooth movement of the units.
- The front and rear panels are designed with perforations for ventilation.
- Is complete with a centralised locking system that ensures maximum security to all your documents.
- A locking stiffener is provided on the last unit to lock all units together.

Measurements



All sizes in cm	Width	Depth	Height
Optimizer Plus: Push-Pull	120.0	40.0	198.0

Optimizer Plus with Push-Pull

Colour & Material

POWDER COAT



Measurements

P1 Push-Pull Type

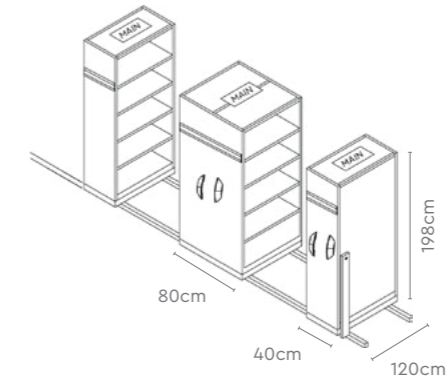

P2 Push-Pull Type

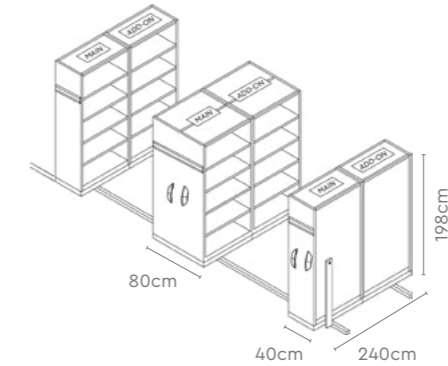

Details



Ventilation Ready

Centralized Locking

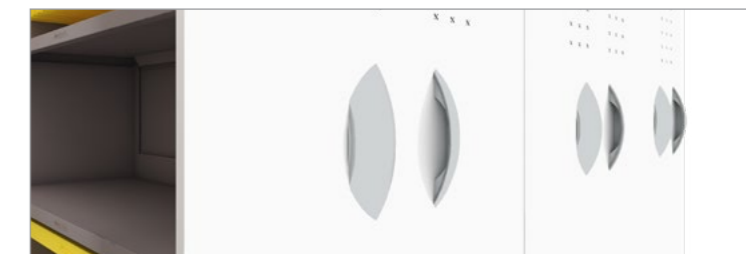

Push-Pull Handle

SPECTRUM

THE COLOUR EXPERIENCE

Colours, Materials, Finishes and Textures

Godrej Interio's Colour System — Spectrum — presents infinite possibilities for creating fresh and inspiring themes for workplaces. In the following pages, we demonstrate some of these possibilities using a curation of workplace themes, and a glimpse of the 100+ colours, materials, finishes and textures we offer.

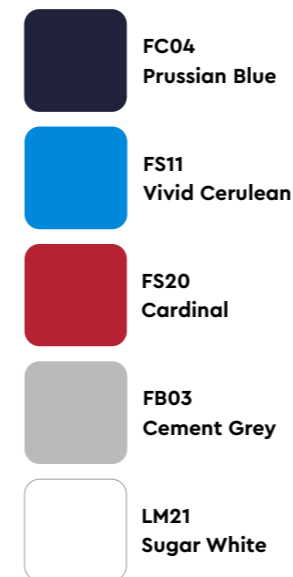

Inspired by Culture

A city rich in history, Jodhpur's architecture, colours and people signify a beautiful blend of traditions and warmth. Even as the city is adapting to urbanization, it communicates to stay rooted while exploring the new.

Inspired by Flavour

Spices define the nature of food, their intensity and combinations can enhance the punch in the flavour. A combination of such colours and materials triggers the required spark for an interesting conversation.





- FO69 Luminous
- PW34 Texas Yellow
- FB03 Cement Grey
- FO24 Blue Iceberg
- LM21 Sugar White

- PW16 Sunset Sky
- PW11 Vivid Cerulean
- PW27 Sugar White
- MB114 Verade Oak Soft Natural

Inspired by Spry

Playing sports is not only a wonderful way to stay fit but it is also one of the best stress busters. Aspects of a game such as energy, team spirit and problem solving are synonymous to today's workforce.

Inspired by Refresh

Urban spaces have made us detached from nature. A refreshing, exhilarating experience of spaces with greens is a welcome break.

- FO14 Vitamin Bright
- FO33 Tree Mist
- PW27 Tex Bond White
- LM44 Warm Grey
- MB116 Amati PC



Inspired by Summer

A summer vacation state of mind with pops of colour, a sense of serenity, friends, sun, sand and sea. A refreshing fun-filled break.

Inspired by Zest

Food is a dominant part of one's culture that helps strengthen the community at a workspace, and chilies are the most common ingredients that can bind multi-cultural cuisines together.

- FL06 Garnet
- PW27 Tex Bond White
- PW14 Gargoyle
- FK01 Black Ink
- LM104 Kitami Elm





-  FL04
Prussian Blue
-  LT52
Dark Tan
-  FL01
Black Ink
-  MB112
Tobacco Ash

Inspired by Regal

A meet that could shape the future needs the right setting and tone. An earthy and contemporary palette brings a feeling of power and authority.





Inspired by Active

Health is the highest priority for a new age worker. Healthy living is a growing focus area that urges us to practice an active lifestyle even at work. It makes us feel positive, energetic and motivated.

-  FS05
Leaf Green
-  FC02
Dark Tangerine
-  FS20
Cardinal
-  PW11
Vivid Cerulean
-  LM21
Sugar White

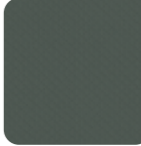

Foam Laminated Fabric Seating (FL)

-  FL01
Black Ink
-  FL04
Prussian Blue
-  FL06
Garnet
-  FL07
Royal Blue
-  FL08
Saddle Brown
-  FL10
Earth Stone
-  FL14
Vitamin Bright
-  FL56
Amethyst Regale

Breakout Fabric Seating (FB)

-  FB03
Cement Grey
-  FB04
Ink
-  FB18
Milan Red
-  FB51
Shadow

Sofa Fabric Seating (FS)

-  FS02
Dark Tangerine
-  FS04
Denim
-  FS05
Leaf Green
-  FS11
Vivid Cerulean
-  FS20
Cardinal
-  FS72
Mink
-  Peacock
-  Flame
-  Citron
-  Cement Grey

Crepe Fabric Seating (FC)



Knitted Fabric Seating (FK)

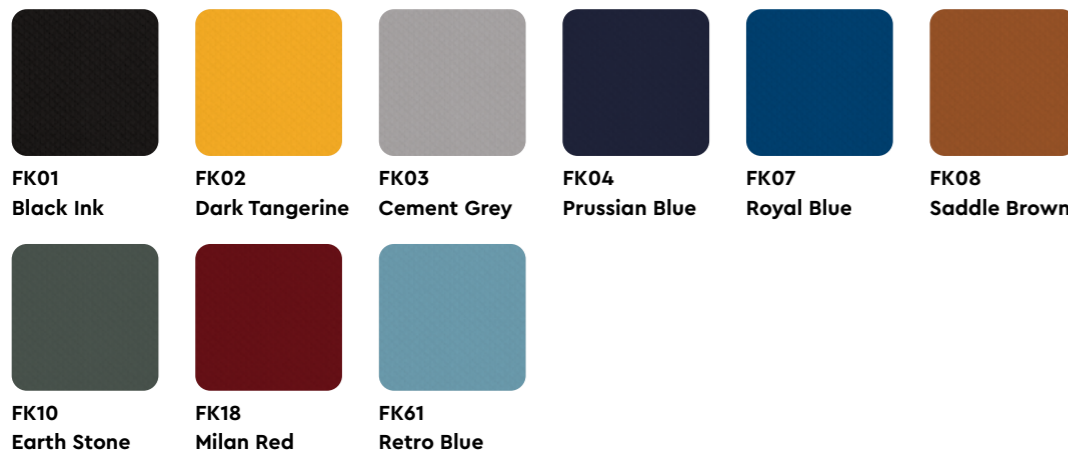

Leatherette Sofa (LS)



Leather (LT)



Leatherette Chair (LC)



Net / Micro Mesh / Spacer Fabric Seating (NM & SF)

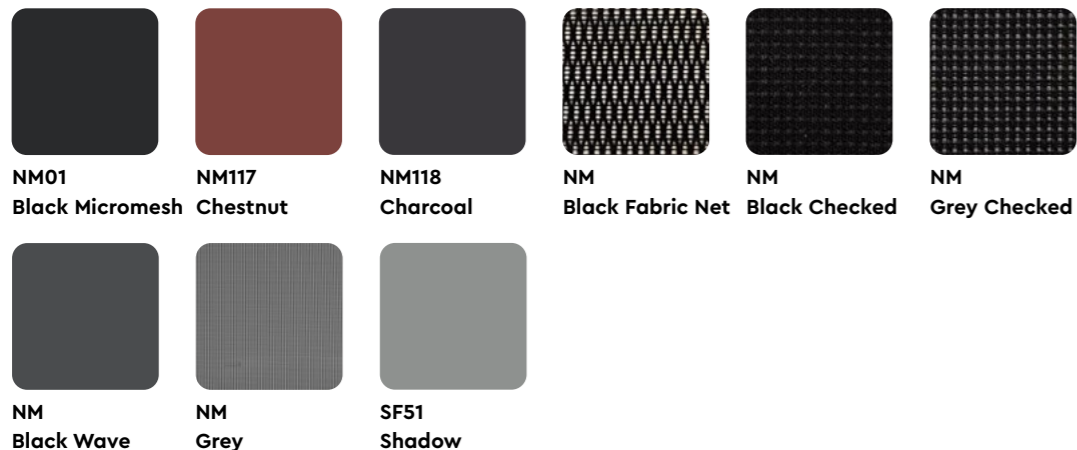

Plush Fabric (FP)



Unwind Range



Laminate (LM)

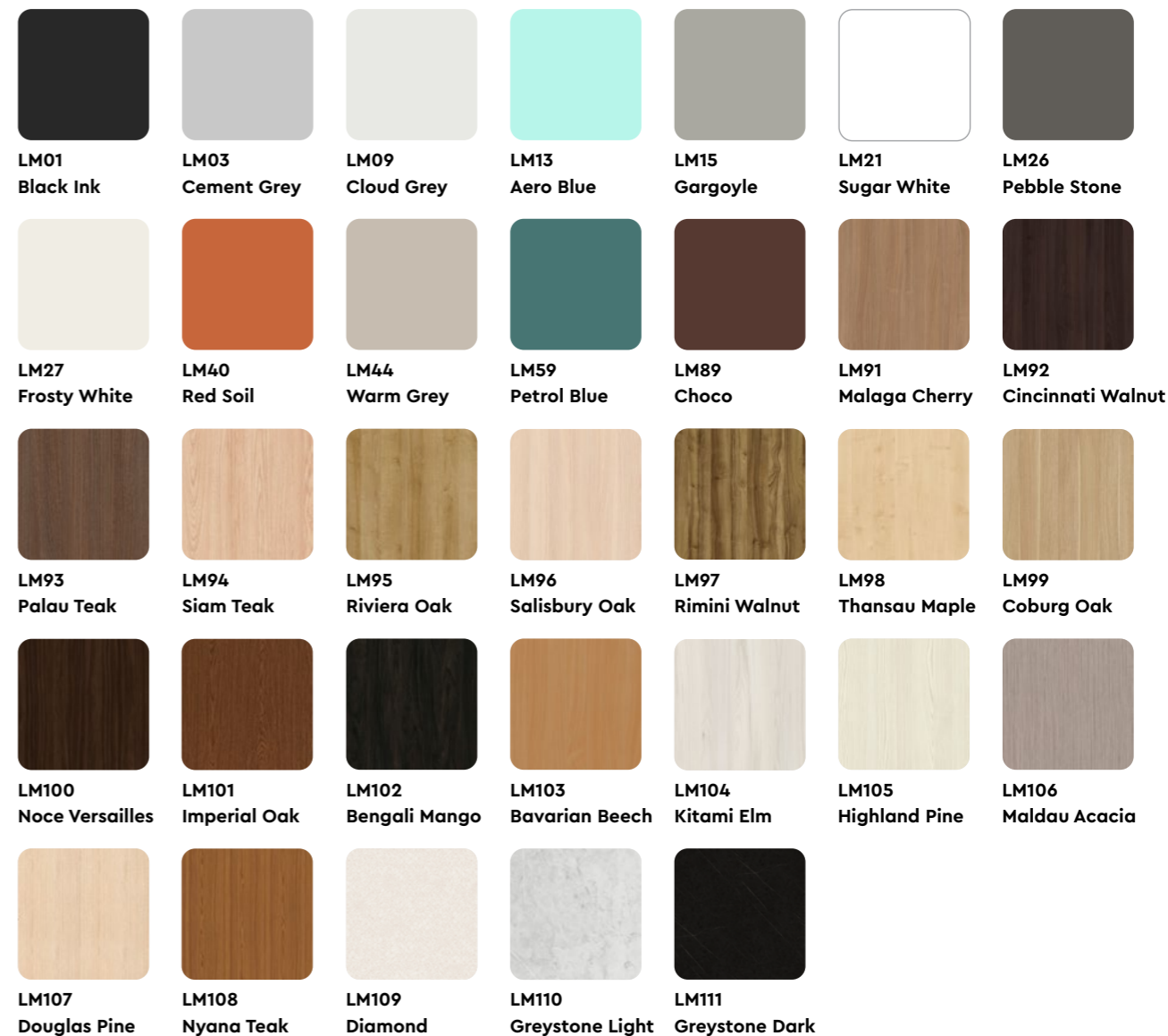

Membrane Range (MB)



Fabric Modular (FO)

						
FO02 Dark Tangerine	FO03 Cement Grey	FO04 Prussian Blue	FO05 Leaf Green	FO06 Garnet	FO07 Royal Blue	FO08 Saddle Brown
						
FO10 Earth Stone	FO11 Vivid Cerulean	FO12 Azure	FO13 Aero Bue	FO14 Vitamin Bright	FO15 Gargoyle	FO16 Sunset Sky
						
FO19 Indian Red Chili	FO20 Cardinal	FO22 Orchid Purple	FO24 Blue Iceberg	FO25 Country Green	FO28 Boysenberry	FO29 Amethyst
						
FO30 Powder Blue	FO31 Blue Grass	FO33 Tree Mist	FO35 Victorian Gold	FO36 Cream	FO38 Oranger Spark	FO39 Burnt Orange
						
FO41 Young Wine	FO42 Copper Moon	FO44 Warm Grey	FO45 Stone Path	FO46 Roasted Bean	FO47 Champagne	FO54 Fresh Leaf
						
FO55 Plum Pastel	FO57 Baby Blue	FO58 Caspian Sea	FO60 Blue Ivy	FO62 Citrus	FO63 Green Sea	FO65 Conifer
						
FO67 Jungle Cane	FO69 Luminous	FO70 Fuscia	FO70 Jaipur Pink	FO73 White Sand	FO75 Acron	FO76 Indian Coffee
						
FO85 Granada	FO86 Latte	FO87 Sliver Line	FO88 Caramel			

Powder Coat (PW)

						
PW01 Black Ink	PW02 Dark Tangerine	PW03 Cement Grey	PW04 Prussian Blue	PW05 Leaf Green	PW06 Garnet	PW09 Cloud Grey
						
PW11 Vivid Cerulean	PW13 Aero Blue	PW14 Gargoyle	PW16 Sunset Sky	PW18 Indian Red Chilli	PW20 Cardinal	PW21 Sugar White
						
PW24 Blue Iceberg	PW26 Pebble Stone	PW27 Tex Bond White	PW33 Tree Mist	PW34 Texas Yellow	PW40 Red Soil	PW41 Young Wine
						
PW44 Warm Grey	PW48 Slate Grey	PW54 Fresh Leaf	PW66 Lime	PW68 Banana Yellow	PW74 Horizon	PW78 Medieval Town
						
PW81 Sepia Brown	PW82 Prince Grey	PW83 Platinum Silver	Matt Taupe White			